



ANZCA

FPM

# Australasian Anaesthesia 2021

RICHARD RILEY



ANZCA

FPM

# Australasian Anaesthesia 2021

**Invited papers and selected  
continuing education lectures**

---

**Editor:**

Richard Riley

Royal Perth Hospital

University of Western Australia

University of Notre Dame

# Contents

<b>BREATHING AND VENTILATION</b>	<b>1</b>
Pandemic planning during a global respiratory crisis: Anaesthesia experience of service redesign at a major teaching hospital in Western Australia <i>Christine Grobler, Lisa Molloy</i>	3
Management of severe Covid disease in the ICU <i>Nicola Dobos, James Douglas</i>	11
Open-source hardware and the great ventilator rush of 2020 <i>Erich B Schulz, Robert L Read, Ben Coombs</i>	25
Is one picture worth 1000 words? How discussions of gas uptake in the lung have been compromised for decades by a single diagram <i>Ben Korman</i>	39
<b>CIRCULATION</b>	<b>51</b>
Atrial fibrillation, ablation, and the anaesthetist <i>Cameron Maxwell, Derek Potgieter, Thomas Bruessel</i>	53
Bubble trouble: Vascular gas embolism <i>Bridget Devaney</i>	65
The expanding role of SGLT-2 inhibitors in the treatment of heart failure <i>Aaron Pym, Ross Hanrahan, Peter Flynn, Thomas Bruessel</i>	73
Anaesthesia for the adult patient with a Fontan circulation undergoing non-cardiac surgery <i>Reza Yusoff, James Preuss, Shannon Matzelle, Cameron Seamen</i>	83
Anaesthetic considerations in the patient with Eisenmenger syndrome <i>Michael H Toon, Cameron Graydon</i>	91
Right ventricular failure – when the right heart goes wrong <i>Richella-Lea Falland, Kate Drummond, Nicole Wylie</i>	103
Management of right ventricular dysfunction after separation from cardiopulmonary bypass <i>Mumtaz Khan, Michael Scerri</i>	115
The perioperative management of patients with ventricular assist devices undergoing non-cardiac surgery <i>Richella-Lea Falland, David Sidebotham, Sara Jane Allen</i>	125
<b>COAGULATION AND BLOOD</b>	<b>135</b>
Transfusion implications in a COVID-19 era <i>Michelle Roets, David Sturgess, Melinda Dean</i>	137
Direct acting oral anticoagulants – pharmacology and perioperative considerations <i>Kate Drummond</i>	147
<b>PAIN</b>	<b>157</b>
An update on intrathecal baclofen <i>Corinne Teh, Sharon Keripin</i>	159
Enhancing powerful medication – applications of the placebo response for pain management <i>Andrew Watson, Thomas Bruessel</i>	165
Aue, Ta fia Ola! Pain and the faaSamoa <i>Leinani Aiono-Le Tagaloa, Brenda Cassidy</i>	175

ISBN: 978-0-6451472-1-6

ISSN: 1032-2515.

Copyright © 2021 by the Australian and New Zealand College of Anaesthetists. All rights reserved. None of the contents of this publication may be reproduced, stored in a retrieval system or transmitted in any form, by any means without the prior written permission of the publisher.

Please note that any views or opinions expressed in this publication are solely those of the author and do not necessarily represent those of ANZCA.

## OBSTETRICS AND GYNAECOLOGY 181

Nitrous oxide use on the labour ward: Efficacy and environmental impact 183  
*Alice Gynther, Fiona Pearson, Forbes McGain*

Epidural labour analgesia: Current trends, advances, and future techniques 193  
*Victor Chen, Harriet Wood*

Labour epidural injustice 203  
*Ian Maddox*

## ASSESSMENT AND PERIOPERATIVE MEDICINE 211

Benefits of anaesthesia preassessment clinics 213  
*Saleem Khoyratty, Rishi Mehra, Aaron Paul*

Use of mobile applications in perioperative medicine 225  
*Josh Szental, Rani Chahal, Gregg Miller*

How can anaesthetists talk to patients with obesity? 237  
*Natalie Smith, Anthony Hodsdon, David A Story*

Preparing the elderly patient for elective non-cardiac surgery 243  
*Naomi Osborne, Leena Nagappan, Kevin Kwan*

Perioperative melatonin: Too good to be true? 257  
*Marli Smit, Dale Currigan*

## TRAUMA AND EMERGENCIES 271

Whakaari/White Island eruption – an overview of volcanic trauma and its management 273  
*John Burnett, Matthew Taylor*

A beginner's guide to in-flight medical emergencies 283  
*Gareth Jones, Nicola Emslie, Dean Bunbury*

## EDUCATION 293

NetworkZ: A multi-disciplinary team training initiative aiming to reduce unintended harm from surgery 295  
*Jennifer M Weller, Jennifer Long, Alan F Merry*

Teaching medical students during clinical anaesthesia placements 303  
*Jeremy Rogers, Jeremy Carman, Andrew Gardner, Ross MacPherson*

## MANAGEMENT AND LEGAL 311

Clinical leadership in uncertain times 313  
*Nicole Sheridan, Candida Marane*

Realising the potential of anaesthesia technicians: The Royal Perth Hospital experience 319  
*Peter Mulrooney, Laura Prates Vitoria*

Socrates, Plato and the healthcare worker's duty to serve 327  
*Elizabeth Hessian, Julian Savulescu*

Medicolegal insights into anaesthesia 339  
*Chris Bolton*

Media moments for anaesthetists 347  
*Simon Hendel, Jonathan (Joff) Lacey*

## Faculty and Regional Editors



**Professor Thomas Bruessel**  
Australian Capital Territory



**Dr Priya Nair**  
College of Intensive Care Medicine



**Dr Brenda Cassidy**  
Faculty of Pain Medicine



**Dr Surbhi Malhotra**  
Western Australia



**Professor Alicia Dennis**  
Victoria



**Dr Sharon Tivey**  
New South Wales



**Dr Thomas Fernandez**  
New Zealand



**Dr Gerald Toh**  
South Australia



**Dr Adrian Langley**  
Queensland



**Dr Maurice Vialle**  
Tasmania

## Preface

Welcome to the 2021 edition of *Australasian Anaesthesia*.

Two years ago, I wrote that the 2019 edition of *Australasian Anaesthesia* was to be my last. I was mistaken about that as well as any other plans I had made for my 2020 retirement. So, rather than living in Japan, I find myself back in this role and once again I am indebted to so many of you, authors, editors, and designers who have excelled during this time to produce a bumper edition.

It has been a biennium like no other. The COVID-19 pandemic has been the most disruptive, dangerous, and challenging period I have witnessed in my 40 years of medicine. At its onset, I even found myself ruminating on the possibility of dying at work, rather than dying en route to work. Reports of healthcare workers becoming seriously ill and dying while caring for patients with the same disease were frightening. In a selfish way, I was relieved when anaesthetists aged 60 and over were deemed unsuitable to be on the hospital intubation team. However, I felt some guilt for those in related specialties who were required to maintain their frontline roles. I saw colleagues shaving their beards, living separate lives from their families, working during their days off, and putting aside other pursuits during this most awful time. Many of us know friends, family members and colleagues who have become sick and even died, if not in our countries, then elsewhere.

At the same time, I have been impressed at the massive efforts of our anaesthesia and intensive care colleagues who have accepted the challenge and faced the disease head on. Equally impressive have been those colleagues who have become leaders of the healthcare response, at local, regional, and national levels. It has been said that anaesthetists are not perceived as natural leaders. Yet when there is a crisis, at a local or global level, we can and do assume such roles. Anaesthetists have taken prominent roles at the medical response to the Bali bombings; the Beaconsfield (Tasmania) gold-mine collapse; the Thai cave rescue; the terrorist attack in Christchurch, New Zealand; and most recently there has been the Whakaari (White Island) volcanic eruption in New Zealand and the global COVID-19 pandemic.

Which brings me to this edition. *Australasian Anaesthesia 2021* features articles on these recent medical catastrophes and even delves into leadership and ethical considerations during these times. There is a wonderful variety of topics to keep your interest and cardiology topics are equally highlighted in this edition.

During these times of stress, fluctuating workloads, and persistent uncertainties, please continue to take care of yourself, your colleagues, and those whom you love.

I wish to thank the authors, the regional editors and ANZCA's Liane Reynolds, Elizabeth Short and Frances Rowsell for their work and support in producing this edition; often working from home. Please thank our authors personally when you can and consider writing for the next edition.

Finally, allow me to acknowledge all those who have faced these challenges despite personal risk. Thank you so much!

### **Associate Professor Richard Riley**

Editor, *Australasian Anaesthesia 2021*  
bluebook@anzca.edu.au





# Breathing and ventilation

**Pandemic planning during a global respiratory crisis: Anaesthesia experience of service redesign at a major teaching hospital in Western Australia**

Christine Grobler, Lisa Molloy

---

**Management of severe Covid disease in the ICU**

Nicola Dobos, James Douglas

---

**Open-source hardware and the great ventilator rush of 2020**

Erich B Schulz, Robert L Read, Ben Coombs

---

**Is one picture worth 1000 words? How discussions of gas uptake in the lung have been compromised for decades by a single diagram**

Ben Korman

---

# Pandemic planning during a global respiratory crisis: Anaesthesia experience of service redesign at a major teaching hospital in Western Australia

## Christine Grobler, MBBCH DA FCA FANZCA

Department of Anaesthesia and Pain Medicine, Royal Perth Hospital, Western Australia

Dr Grobler is deputy director of the department of anaesthesia and pain medicine and the director of trauma anaesthesia in the department of anaesthesia and pain medicine at Royal Perth Hospital. She sits on the hospital and state trauma committees, is immediate past chair of the WA ANZCA Regional Committee and clinical lead for the Rural Health West Outreach Anaesthesia Program.

## Lisa Molloy, MB BCH BAO (Hons) BA FCAI FANZCA

Department of Anaesthesia and Pain Medicine, Royal Perth Hospital, Western Australia

Dr Molloy has completed fellowships in malignant hyperthermia, trauma anaesthesia, airway and paediatrics, and now works as a specialist anaesthetist at Royal Perth Hospital.

## INTRODUCTION

*"The world has to maintain vigilance against the recurrence of outbreaks from environmental sources or laboratories. Global efforts and co-operation are required to control devastating pandemics as our world is miniaturised by rapid air travel!"*<sup>1</sup>.

On 11 March 2020, the World Health Organization (WHO) declared the novel coronavirus SARS-CoV-2 (COVID-19) outbreak a global pandemic. Following the declaration, many changes and plans were implemented within hospitals in Australia in preparation for the pandemic. At the time of the declaration, the definitive transmission and characteristics of COVID-19 were not fully understood, but like other respiratory pathogens, it was thought to be predominantly droplet spread with aerosol transmission in certain settings.

The majority of influenza-like illnesses are believed to spread via droplets (>5 microns) and airborne transmission is not considered likely unless an aerosol generating procedure (AGP) (see Table 1) is being performed. Airborne transmission is believed to occur when a susceptible host inhales infectious particles contained in small aerosols (<5 microns)<sup>2</sup>. The risk for airborne transmission to healthcare workers (HCWs) therefore exists when treating patients with a pathogen known to spread via the airborne route (for example, measles, TB, SARS and MERS), when conducting an AGP, or with a novel respiratory virus where the modes of infection, transmissibility or characteristic are not yet clearly understood (for example, COVID-19)<sup>3</sup>.

### Table 1. Aerosol generating procedures (AGPs)

Reproduced with permission from the Communicable Disease Control Directorate, WA Health for the identification and use of PPE in the clinical setting during the coronavirus pandemic 9 April 2020.

#### AGPs include:

- Bag and mask ventilation.
- Tracheal intubation and extubation.
- Tracheostomy.
- Ventilation via supraglottic airway (including insertion and removal).
- Non-invasive ventilation including CPAP and BiPAP.
- High flow nasal oxygen therapy.
- Diagnostic and therapeutic instrumentation of the airway including bronchoscopy.
- Nebuliser administration.
- Sputum induction.
- Open airway suctioning.
- Surgical AGPs.

It was clear that change needed to occur rapidly within our hospital to deal with newly emerging challenges. Concerns were raised around health workers' personal protective equipment (PPE) in terms of what was appropriate PPE for particular situations and the availability of PPE within the state and also there were

concerns re staff education and welfare. Decisions were required regarding a dedicated intubating team, Critical Care Outreach Teams and potential staff re-deployment across critical care areas. Regular multi-disciplinary working groups were necessary to map the hospital journey for COVID-19 patients; theatre adaptations and plans for critical care pods were vital.

## PERSONAL PROTECTIVE EQUIPMENT – INTRODUCTION OF FIT TESTING

The two main types of air-purifying respirators used (referred to as respirators hereafter) are either powered (PAPR) or non-powered. Non-powered respirators utilise the negative pressure generated by the wearer to draw air through the filter and thereby purify it. Multiple international and national guidelines exist which state that fit-testing should be carried out prior to a respirator being used for the first time<sup>4-6</sup>.

N95 filtering respirators should filter 95 per cent of airborne particles up to 0.3 microns in size, which is the most penetrable size by air. Both P2 and N95 respirators are considered suitable for use in HCWs for this purpose. P2 respirators are most commonly used in Europe and comply with the AUS/NZ 1716 standard. N95 respirators are those which have been approved and certified by the United States Institute for Occupational Health and Safety (NIOSH). Both of these respirators are single use only<sup>7</sup>. In our hospital, we had small and medium Halyard and BSN Proshield N95 masks available in theatre, but only one size was available in other parts of the hospital.

At the time of the COVID-19 outbreak, fit testing was not part of our institutional protocol and was not routinely carried out at any other hospital within Western Australia (WA). A fit check was the appropriate minimum standard required in hospitals, and although fit testing was the Australian gold standard<sup>9</sup> there existed no mandatory requirement at a national or state level. Based on the premise that there was some uncertainty on the method of spread at the time the COVID-19 pandemic was declared, and due to the nature of the clinical work and the role that anaesthetists would play during a respiratory pandemic, we believed our staff to be at sufficiently high risk to initiate the introduction of qualitative fit-testing within our department. Similar measures were taken at other institutions within metropolitan WA.

## THE EDUCATIONAL BENEFITS – A FIT-TEST VS A FIT-CHECK

A fit-test aids to ensure that the correct size of respirator is chosen by the wearer to ensure unfiltered air is not entrained from a poorly fitting mask. The average penetration by ambient aerosols can be 33 per cent for a poorly fitting respirator versus 4 per cent for a well-fitting respirator<sup>9</sup>. A fit-test should be conducted annually, whereas a fit-check needs to be undertaken every time a wearer uses a respirator. For the inexperienced wearer, a fit-check can be incorrectly done around 25 per cent of the time. It is reasonable to assume that the willingness of a HCW to work during an infectious respiratory pandemic will depend on perceived risk. Asking a wearer to perform a fit-check for the first time in a clinical scenario which is time critical and highly stressful does not assuage any such perception, nor does it instil faith within the wearer. Past experience has shown that the majority of HCWs who become infected do so during the first few days of exposure when understanding, protocol familiarity and vigilance in the correct use of respirators is the lowest<sup>10</sup>.

A fit-test utilises either a “qualitative” or “quantitative” method to determine whether a particular size, type and model of respirator will give the wearer an adequate seal if worn correctly<sup>7</sup>. The qualitative method relies on detecting leakage of a test substance into the face piece. This is a subjective test; it neither measures nor allows testers to quantify the actual amount of any leakage. The two main qualitative solutions used are saccharin, which leaves a sweet taste, and Bitrex solution, which leaves a bitter taste in the subject’s mouth. Qualitative fit testing is generally used for half-mask respirators. Quantitative fit-testing on the other hand, can be used for any tight-fitting respirator, including full face respirators, and utilises a machine to measure the actual amount of leakage which occurs<sup>11</sup>.

Our department used the Bitrex qualitative fit-testing method and the trainers were certified remotely by the 3M safety representative. It is an inexpensive test when compared with quantitative fit testing, simple to use, is portable and the masks are not damaged during the test and can be reused by the wearer in to minimise waste of PPE. However, qualitative fit testing is subjective, may be claustrophobic and is dependent on the subject tasting the solution.

As a department, it was decided that all intubations would be carried out by senior staff – anaesthesia consultants and fellows. All senior anaesthesia staff rostered to work during the initial outbreak were tested, unless they were over the age of 60 years or had a medical condition which precluded them from treating COVID-19 patients – (see RIDER criteria Table 2). Anaesthesia technicians who formed part of the anaesthesia intubating team (hereafter referred to as the SWAT team) were also tested.

## Table 2. RIDER criteria

Reproduced with permission from the WA DOH RIDER interim plan, January 2020.

Note: The table refers to pathogen X and the plan was approved prior to COVID-19 becoming a pandemic.

As per the WA DOH Interim Respiratory Infectious Diseases Emergency Response (RIDER) plan, HCW with the following are considered high risk:

- Pregnant women.
- Individuals with chronic respiratory conditions including asthma and chronic pulmonary disease (COPD).
- Persons with morbid obesity.
- Persons with chronic illness predisposing to severe respiratory disease such as cardiac disease (excluding hypertension)/diabetes mellitus/chronic renal disease/haemoglobinopathies/ immunosuppression (including that caused by cancer, medications or HIV/AIDS infection)/chronic neurological conditions.
- Other conditions, as appropriate.

## NO “ONE SIZE FITS ALL” – THE PROOF IN THE PUDDING

The design of respirators has been based on facial size and shape measurements. Earlier designs used respiratory fit test panels (RFTP) which were based on measurements originally from American air forces personnel – predominantly Caucasian males. These RFTP were then used to design masks for the general population. Facial characteristics and shape differ between ethnic groups, and the same respirator may not give the same level of protection to all wearers. Papers published from lessons learnt during the SARS pandemic highlighted the same<sup>3,12,13</sup>.

Following the fit-testing within our department, we audited the results which showed that the “one size fits all” belief was indeed false. Despite re-testing, we found that an adequate seal could not be achieved with the “first line” BSN Proshield mask in 17 per cent of our staff. Prior to re-testing, our first pass rate was 60 per cent. Consequently, we attempted to source alternate brands for our anaesthetists. We encountered numerous obstacles and difficulties in trying to source alternate brands during a pandemic due to worldwide shortages. Options were limited during the pandemic due to import restrictions and multiple delays occurred due to service disruptions in freight and courier companies.

Early in the pandemic, the COVID-19 Pandemic Infection and Control Clinical Advisory Group was created within the WA Department of Health. This committee was responsible for the provision of advice regarding product selection and the management of state wide stockpiles and distribution of PPE, thus centralising all PPE access. Over time, more N95 masks became available in the central warehouse, which were suitable for those staff members who failed their fit test with the “duck billed” N95 masks. The Department of Health has also recommended the use of CleanSpace Halo systems (a portable, lightweight air-purifying power unit) for which training has been rolled out. Plans to use another PAPR system were abandoned as that brand had not been approved by the TGA.

Following the decision of various anaesthesia departments across metropolitan WA to introduce their own qualitative fit-testing, the results enabled each department to feedback to the Health Executive. The WA Department of Health have since introduced quantitative fit-testing for all frontline employees. We hope to establish this as a permanent part of an employee’s orientation package to the hospital.

## PSYCHOLOGICAL WELLBEING – WELFARE AT THE HEART OF IT

Another lesson learnt from the SARS pandemic was the need for a focus on staff wellbeing. Although patient and staff safety are central tenets, staff resources may be depleted early in any pandemic due to both illness and poor morale<sup>3</sup>.

At the beginning of the pandemic, our departmental welfare officers recognised that physical distancing, especially within the social hubs of the department, meant staff were not interacting with each other as frequently or meaningfully as before. This, combined with mounting stress induced by health anxieties, separation from family, formal exam uncertainty and so on, meant there was a significant concern for the psychological wellbeing of the department. A “checking-in” chain was rapidly established and at the time of press is ongoing. The chain utilises a core group of consultants and registrars who have committed to contacting and supporting an allocated small group of colleagues on a regular basis. This “checking-in” attempts to mitigate the effects of social isolation and identify anyone who may be struggling with their circumstances and/or mental health. It was well received within the department from inception and has subsequently been adopted by other departments within the hospital.



Additionally, the hospital pastoral care service provided training sessions to numerous staff members within our department with the aim of improving listening skills and confidence in initiating conversations around mental health. The team also offered a confidential avenue of support, outside the department, for any staff members in distress.

Considerations for staff physical wellbeing were also made. Care bundles consisting of toiletries were stored within the department for use following a COVID-19 exposure procedure. Extra rest space was created to allow for adequate rest while maintaining social distancing. Links to online exercise classes and exercise regimes were provided to staff to facilitate wellbeing and for those unable to attend gym classes due to mandatory closures. Office spaces were also reconfigured to accommodate additional sleeping mattresses, in anticipation of an increased after-hours workload and shift pattern.

For members of staff who felt they could not return home following contact with a COVID-19 patient (due to living with vulnerable family members), special hotel rates were organised by the hospital executive with local hotels.

All of these welfare provisions were regularly shared with the department via regular “COVID-19 Welfare” email updates, which also included links to other useful wellbeing resources.

## “FRONTLINE” HEALTH CARE WORKERS – GENESIS OF CORE INTUBATING TEAM CONCEPT

The abundance of literature which has emerged from the Wuhan experience, has aided and guided pandemic preparedness across multiple WA institutions. Among the models of care, was the inception of dedicated airway response teams<sup>14,15</sup>. The belief was held that by choosing a small group of anaesthetists to form the airway response team would allow for focussed training and repetitive practise of important pathways. It also facilitated early consolidation of core PPE principles, allowing for minimisation of risk through familiarity. During the early period of the COVID-19 pandemic, when uncertainty existed regarding the exact transmission mode, it was reasonable to assume that patients were likely to be maximally infectious at their time of ICU admission as they were during the SARS pandemic<sup>10</sup>. By having a small group involved in intubating, we hoped that early lessons learnt would be concentrated and the knowledge could then be distilled to the wider group in a more controlled manner.

WA major training hospitals were early adoptees of this approach and anaesthesia intubating teams were created. At our hospital, the premise was that all COVID-19 intubations for the entire hospital (for example, intensive care unit, emergency department and negative pressure rooms on the respiratory unit), would be carried out by the SWAT team. This was an anaesthesia consultant-led service and a separate roster was established for on-site and afterhours cover from home 24/7 at the beginning of the pandemic. As our state numbers decreased, the SWAT team was disbanded after seven months, and extra cover for COVID-19 patients is now provided by the general on call consultant from home.

Storage areas became necessary in remote areas for airway equipment, COVID-19 trolleys and cognitive aids, examples of these areas being respiratory wards and the COVID-19 testing clinic. A backpack was created containing additional miscellaneous equipment not readily available in other locations – single use laryngoscopes, CMAC blades, stylets, bougies, various sized suction above cuff endotracheal tubes (SACETT) and iGel LMAs. This was initially carried by members of the SWAT team and is now carried by the medical emergency team (MET) anaesthesia registrar. The pharmacy also created specific COVID-19 intubation drug packs containing drugs necessary for intubation and haemodynamic stabilisation for use in remote locations. These drugs included ketamine, fentanyl, midazolam, propofol, metaraminol and various muscle relaxants. The quantity of drugs included in the pack allowed for both induction and maintenance infusions in preparation for transfer to ICU.

## HOSPITAL ADAPTATIONS – NEGATIVE PRESSURE THEATRES AS A FUTURE POSSIBILITY

During the period when elective work was ceased, the decision was supported to change the pressure differential within one of the operating suites to convert it to a “negative pressure” operating suite (relative to the anaesthesia room and theatre corridors). This was achieved by reducing air inflow without altering outflow or laminar flow characteristics. This became our dedicated COVID-19 theatre. Change to a “negative pressure theatre” has not been achieved within our institution in the past, despite the fact that we have for years, and continue to conduct, both surgical (for example, bronchoscopies, lung biopsies) and anaesthetic AGPs on patients requiring airborne precautions. Our institutional guideline advocates that AGPs in patients under airborne precautions be performed in a negative pressure room if practical. The theatre anaesthesia room then became the donning area for anaesthesia staff and preparation zone prior to the arrival of the patient, with all necessary equipment, including PPE being kept on a dedicated COVID-19 trolley.

## HOSPITAL ADAPTATIONS – THE RISE OF SURGE CAPACITY

Reconfiguration of the emergency department (ED) occurred with the creation of a new Acute Respiratory Illness Zone (ARIZe) for the acute management of COVID-19 or suspected COVID-19 cases presenting to the hospital. All patients were triaged outside ED before entry and then assigned to a zone. The ARIZe area was cordoned off from the rest of the ED and hospital and designed to facilitate a “one-way” patient flow model. It was accessible only by staff working in that area to reduce the risk of cross contamination. It had a dedicated elevator to the COVID wards, stopping only on these floors and the fourth floor, which allowed access to ICU and theatres. ARIZe contained six negative pressure high acuity rooms with ample space for PPE donning and doffing, where patients could be intubated prior to transfer to ICU. Creation of a separate zone allowed for low-risk patients, including multi-trauma patients, to be treated separately with the business-as-usual model. It was accepted that the occasional COVID patient could be missed, especially if asymptomatic, but overall it was hoped that by dividing ED into the two main sections it would lower the risk to both staff and patients. Our ED has subsequently converted back to its usual configuration for triage, patient flow and use of clinical areas.

In preparation for an increased demand for critical care beds, escalation plans were established in conjunction with ICU and ID/IPM (infectious diseases/infection prevention medicine) to accommodate extra ICU patients outside of the dedicated ICU unit. One of our day surgery admission units adjacent to ICU was recommissioned and within a short period of time, three extra isolation rooms were built. ICU equipment was also moved to establish an extra eight fully equipped high acuity beds in this area. In addition to this, other areas were identified for surge capacity including operating theatres, the Coronary Care Unit and the State Trauma Unit should the need arise. Patients could be ventilated in part of the theatre complex under the care of ICU and the anaesthesia department, while also allowing non-COVID emergency cases to continue in other areas of the theatre complex. Including all ICU appropriate areas (others were also identified) within the hospital, this would allow for ICU numbers to substantially increase from 24 to 98.

Anaesthesia registrars with previous ICU experience were identified and allocated to ICU for one week for skills expansion, familiarisation with ICU protocols and ventilators, in preparation for re-deployment to ICU during the pandemic. Preparation was made on the anaesthesia roster for consultants to cover anaesthesia registrar shifts if necessary. Several anaesthesia technicians were also allocated to ICU to support the respiratory technicians and become familiar with equipment.

Recovery nursing staff were also deployed to ICU for upskilling, and other hospital nursing staff with critical care experience were identified and received education. An educational program was started for theatre nurses, should they be required to help with the recovery of patients in theatre.

During the initial period of the pandemic, arrangements were made between all of the large teaching and training hospitals, so that staff were based in one hospital only, and not across multiple sites, thereby minimising risk of cross-site infection if one staff member was infected. As with most healthcare facilities, efforts to minimise future potential spread have resulted in stricter entry points and limited access to the hospital by the public.

Throughout the pandemic, twice-weekly meetings were established between ICU, infectious diseases, anaesthesia, physiotherapists, allied health, nursing staff, pharmacy and the executive to facilitate communication for surge capacity planning.

## EDUCATIONAL OPPORTUNITIES – FUTURE PANDEMIC PREPAREDNESS

The pandemic raised both our awareness of and familiarity with infection control principles. Across healthcare institutions, we could exploit this renewed interest to re-appraise historical standards and bring about change.

A statewide multi-pronged approach was employed. Collaborative groups, including virtual group forums and online information repositories were established across metropolitan and regional Western Australia (WA) to effectively share local, national and international knowledge and guidelines, and problem solve clinical dilemmas that were encountered or those that could potentially occur.

New up-to-date institutional management guidelines, protocols and checklists were developed and published and departmental pandemic preparedness strategies were developed and disseminated. Visual guides to assist and remind staff in evidence-based clinical management were developed and presented both online and in print form and made available in all clinical areas.

Audiovisual resources were generated from multiple anaesthesia departments to provide instruction on the correct technique for safe airway management of the COVID-19 patient, including the donning and doffing of PPE, intubating/extubating COVID-19 patients and transferring these patients from a remote location. In collaboration with other WA hospitals, dedicated airway trolleys and “shadow boards” for intubation

were designed. The pandemic highlighted that we were ill prepared and had no plans in place to deal with an infectious respiratory threat. To improve pandemic preparedness, low and high-fidelity simulations for staff were held across multiple clinical environments including the ED, medical wards and theatres. As part of an ongoing pandemic preparedness strategy, our department undertakes quarterly online PPE refresher courses and annual practical PPE sessions run across our institution. As a result of increased meetings and training, inter-departmental relationships were strengthened.

Departmental teaching and business meetings moved to a virtual platform to reduce the risk of spread. Caps were placed on numbers allowed in the seminar room, and these caps remain, with all others joining meetings virtually via Microsoft Teams from their own offices. The move towards online meetings has allowed for international speakers to be involved in our departmental meetings on a regular basis.

The pandemic has also encouraged us to use telehealth and phone consultations. Telehealth, until now has been used almost exclusively for rural patients, but during the pandemic, there was a rapid expansion in the use of phone and video consultations for all patient groups allowing healthcare to continue while minimising exposure to both staff and patients at the same time. One hundred additional rooms were equipped with webcams for outpatient telehealth appointments and 200 additional staff were trained to deliver telehealth services. Between January and June 2020, over 30 per cent of patients over the age of 60 from regional and metropolitan areas attended their general outpatient appointments via telehealth – more than double the number of appointments in 2019<sup>16</sup>. Seventy per cent of Aboriginal patients living in rural and remote communities attended their appointments via telehealth in April 2020. The use of telephone and video consults peaked in April 2020 with an average 62 per cent of patients from metro and regional areas attending their appointments virtually – almost six times more than pre-COVID-19 periods. Overall during the first six months of 2020, there was a 700 per cent increase in the use of video consults compared with 2019<sup>16</sup>. Telehealth, predominantly phone consults, were used by our department for preoperative appointments and malignant hyperthermia services, while the pain service used a combination of video and telephone consults. Peak usage for the pre-assessment clinic were the months of April and May, with over 90 per cent of patients having telephone/video appointments<sup>16</sup>. Although the transition to phone consults took time to adjust, it allowed us to continue assessing patients during the pandemic and minimise exposure for both patients and staff while continuing with daily clinics.

## LESSONS LEARNT – GROWTH IN THE TIME OF COVID

COVID-19 caught us all unaware. It exposed deficits in our systems and revealed how easily day-to-day healthcare can be disrupted. The pandemic also demonstrated the need for adaptations to daily routines and that working outside one's usual clinical area may be necessary in a pandemic. The need for communication between departments, executive staff and other metropolitan hospitals was highlighted, allowing us to share ideas, skills and resources. The importance of collaboration between WA hospitals was shown by allowing access to shared resources, thereby providing a safe environment for both staff and patients. Increasing use of telehealth and telephone consultations, has demonstrated this form of consultation may be appropriate to continue in a larger capacity long term, and the necessity for clinicians to embrace digital technology as normal service. Its sudden introduction also highlighted the need for computer and equipment upgrading. From a PPE aspect, WA Health's introduction of fit testing for all frontline staff, has emphasised the importance of effective use of this component of PPE for staff safety.

## CONCLUSION

In comparison to other parts of the world, we have been very fortunate in western Australia with our COVID-19 numbers. Despite our low numbers, much has been learnt and much has changed within our hospital since the declaration of the pandemic. The COVID-19 and suspected COVID patients we now treat are from hotel quarantine and international ships. The extra time compared with our colleagues elsewhere in Australia, has given us time to prepare for what lies ahead. Social distancing and virtual meetings have become the norm. Periodic simulations continue as refreshers in anticipation of another COVID wave and visual guides are readily available in theatres. The pandemic has helped us forge better communication and relationships between various departments, and between departments and the hospital executive staff. WA health quantitative fit testing commenced in early 2021. Vaccination of hospital staff has commenced and is ongoing. COVID-19 has shown us that life can change rapidly, necessitating an accordingly rapid response in our professional, social and personal lives.

## REFERENCES

1. Tai DYH. SARS: How to Manage Future Outbreaks? *Annals Academy of Medicine*. 2006;35(5):368-373.
2. World Health Organization. Modes of transmission of virus causing COVID-19: implications for IPC precaution recommendations. Scientific brief. March 2020. Available from: <https://www.who.int/news-room/commentaries/detail/modes-of-transmission-of-virus-causing-covid-19-implications-for-ipc-precaution-recommendations>
3. Gomersall C, Loo S, Joynt GM, Taylor BL. Pandemic preparedness. *Curr Opin Crit Care*. 2007 Dec;13(6):742-747.
4. AS/NZ1715:2009 – Selection, Use and Maintenance of Respiratory protective equipment. Standards Australia. 2009.
5. United States Department of Labor: OSHA guidelines 1910.134. Personal Protective Equipment – Respiratory Protection. 2006. Available from: <https://www.osha.gov/laws-regs/regulations/standardnumber/1910/1910.134>
6. Health and Safety Executive UK. Guidance on respiratory protective equipment (RPE) fit testing. Her Majesty's Stationary Office. 2019. Available from <https://www.hse.gov.uk/news/face-mask-ppe-rpe-coronavirus.htm>
7. WA Department of Health Information Circular. Fit testing and fit checking of particulate filter respirators (masks) in Western Australian Healthcare Facilities 2013. IC:0142/13 File No: F-AA-13890. Available from <https://ww2.health.wa.gov.au/-/media/Files/Corporate/Policy-Frameworks/Unallocated/Policy/Fit-testing-and-fit-checking-of-particulate-filter/IC142-Fit-testing-and-fit-checking-of-particulate-filter-respirators.pdf>
8. National Health and Medical Research Council Australian Guidelines for the Prevention and Control of Infection in Healthcare v10.5. 2020. Available from [https://files.magicapp.org/guideline/b9cc95f9-727b-48c8-bdfb-e1112922b1d/published\\_guideline\\_4116-10\\_5.pdf](https://files.magicapp.org/guideline/b9cc95f9-727b-48c8-bdfb-e1112922b1d/published_guideline_4116-10_5.pdf)
9. Gomersall CD, Tai DY, Loo S, Derrick JL, Goh MS, Buckley TA, et al. Expanding ICU facilities in an epidemic: recommendations based on experience from the SARS epidemic in Hong Kong and Singapore. *Intensive Care Med*. 2006 Jul;32(7):1004-13.
10. Gomersall CD, Joynt GM, Ho OM, Ip M, Yap F, Derrick JL, Leung P. Transmission of SARS to healthcare workers. The experience of a Hong Kong ICU. *Intensive Care Med*. 2006 Apr;32(4):564-9.
11. United States Department of Labor Occupational Safety and Health Administration (OSHA). Respirator Fit Testing. Available from [https://www.osha.gov/video/respiratory\\_protection/fittesting\\_transcript.html](https://www.osha.gov/video/respiratory_protection/fittesting_transcript.html)
12. Zhuang Z, Coffey CC, Ann RB. The effect of subject characteristics and respirator features on respirator fit. *J Occup Environ Hyg*. 2005 Dec;2(12):641-9.
13. Wilkinson IJ, Pisaniello D, Ahmad J, Edwards S. Evaluation of a large-scale quantitative respirator-fit testing program for healthcare workers: survey results. *Infect Control Hosp Epidemiol*. 2010 Sep;31(9):918-25.
14. Yang M, Dong H, Lu Z. Role of anaesthesiologists during the COVID-19 outbreak in China. *Br J Anaesth*. 2020 Jun;124(6):666-669.
15. Aziz MF. The COVID-19 intubation experience in Wuhan. *Br J Anaesth*. 2020 Jul;125(1):e25-e27.
16. East Metropolitan Health Service. RPBG Outpatient Service Report in Response to COVID-19 Pandemic. January to June 2020. Internal Bulletin.

## Management of severe Covid disease in the ICU

### Nicola Dobos MBBS MPH FCICM

**Intensive Care Specialist, Department of Intensive Care Services, Western Health, Melbourne, Australia**

Dr Nicky Dobos is a staff specialist intensivist at Western Health in Melbourne. She is also the New Fellows' Representative on the board of the College of Intensive Care Medicine (CICM) and chair of the Trainee Committee. Nicky's interests include obstetric critical care, advanced communication, medical education and mentorship.

### James Douglas MBBS (Hons) FRACP FCICM DTM&H

**Intensive Care Specialist, Department of Intensive Care Services, Western Health, Melbourne, Australia**

Dr James Douglas completed joint training in Internal Medicine and Intensive Care in Melbourne, Australia before completing fellowships at the Royal Children's Hospital and Guy's and St Thomas' Hospital in London. James works as a staff specialist intensivist at Western Health in Melbourne and has interests in mechanical ventilation and medical education.

## INTRODUCTION

Coronavirus disease 2019 (COVID-19) is an infectious disease caused by the highly contagious severe acute respiratory syndrome coronavirus 2 (SARS-CoV-2). A novel coronavirus was identified in Wuhan in late 2019 through the "pneumonia of unknown aetiology" surveillance program and was linked to the Huanan Seafood wholesale market<sup>1,2</sup>. Prior to 2019, there were six coronaviruses that were known to cause human disease. Of these, four cause the common cold, while more serious disease was caused by the severe acute respiratory syndrome (SARS) and Middle East respiratory syndrome (MERS) coronaviruses. COVID-19 has subsequently led to a global pandemic with unprecedented consequences to human health and society, leading the World Health Organization (WHO) to declare a global emergency in January 2020. The morbidity and mortality rates due to the pandemic are increasing rapidly worldwide, causing overwhelming impacts on current and ongoing provisions of intensive care.

## CLINICAL FEATURES OF SEVERE COVID-19

Premorbid risk factors that predict progression to severe or critical illness with COVID-19 include age and underlying medical conditions. However, the exact potential effect of various comorbidities on the severity of COVID-19 illness is unclear and predicting disease trajectory from the time of symptom onset is difficult<sup>3</sup>.

Patients with COVID-19 present most commonly with fever (temperature > 38 degrees Celsius), cough, shortness of breath, anosmia and fatigue<sup>4</sup>. Clinical features of severe infection include interstitial pneumonia, respiratory failure, acute respiratory distress syndrome (ARDS) and sepsis<sup>5</sup>.

Critically ill COVID-19 patients typically develop pneumonia approximately five days following symptom onset and severe hypoxaemic respiratory failure requiring intensive care unit (ICU) admission at approximately day seven to 12<sup>3</sup>.

Severity of infection with COVID-19 can be classified as mild, moderate, severe or critical, as per the Australian Guidelines for the Clinical Care of people with COVID-19 (see Table 1).

**Table 1. COVID-19 Disease Severity Classification<sup>6</sup>**

<b>Mild illness</b>	Asymptomatic, or Mild upper respiratory tract symptoms, or Cough, myalgia, asthenia without shortness of breath or reduction in oxygen saturation.
<b>Moderate illness</b>	Oxygen saturations of >92% on up to 4L/min oxygen via nasal prongs. Prostration, severe asthenia, fever >38° C or persistent cough. Clinical or radiological signs of lung involvement. No clinical or laboratory indicators of clinical severity or respiratory impairment.

<b>Severe illness</b>	Adult patients meeting any of the following criteria: <ul style="list-style-type: none"> <li>Respiratory rate <math>\geq 30</math> breaths/min, or</li> <li>Oxygen saturation <math>\leq 92\%</math> at rest, or</li> <li>Arterial partial pressure of oxygen (PaO<sub>2</sub>)/ inspired oxygen fraction (FiO<sub>2</sub>) <math>\leq 300</math>.</li> </ul>
<b>Critical illness</b>	Adult patients meeting any of the following criteria: Respiratory failure <ul style="list-style-type: none"> <li>Severe respiratory failure (PaO<sub>2</sub>/FiO<sub>2</sub> <math>&lt; 200</math>), respiratory distress or ARDS. This includes patients deteriorating despite advanced forms of respiratory support (non-invasive ventilation (NIV), high-flow nasal oxygen (HFNO)) OR patients requiring mechanical ventilation.</li> </ul> OR other signs of significant deterioration <ul style="list-style-type: none"> <li>Hypotension or shock.</li> <li>Impairment of consciousness.</li> <li>Other organ failure.</li> </ul>

## ASSESSMENT FOR SUSPECTED COVID-19

All patients presenting with any of the documented symptoms or signs of COVID-19 should be tested and considered “suspected COVID” until proven negative, according to both risk stratification, epidemiology and microbiological tests. Given the non-specific nature of many of the clinical features of COVID-19, it is important to maintain a high index of suspicion and test all potential cases.

The test of choice to confirm COVID-19 infection is viral PCR, with swab samples from both the oropharynx and nasopharynx to optimise virus detection. Sputum samples should also be obtained where possible. Avoid bronchoscopy and bronchoalveolar lavage due to the risk of aerosolisation, unless there is a strong suggestion that it may change management.

A full septic screen should be considered for all suspected or confirmed COVID-19 patients admitted to ICU, including blood, urine, sputum and faecal cultures, atypical pneumonia screen and chest radiograph.

Common observations in laboratory abnormalities in severe and critically unwell COVID-19 patients include lymphocytopenia, elevated ESR and CRP, as well as elevated ferritin levels<sup>7</sup>. Very high ferritin levels ( $> 700\text{ng/ml}$ ) seen in severe COVID-19 patients may be a marker of overwhelming systemic inflammation and increased risk of cytokine storm syndrome<sup>8</sup>. The cytokine storm may be responsible for two main causes of mortality in COVID-19, ARDS and secondary haemophagocytic lymphohistiocytosis<sup>9</sup>.

Serological tests detect evidence of recent infection and are therefore not used in the acute assessment or management of COVID-19 ICU patients.

Severe COVID-19 pneumonia can present with bilateral opacities on chest radiograph or ground-glass opacities with or without consolidation on chest CT. Other less common findings include pleural effusions, interstitial disease and pericardial effusion.

## ICU ADMISSION CRITERIA FOR COVID-19 PATIENTS

Admission to ICU with COVID-19 depends on a number of factors, including patient age, comorbidities and clinical state. It is also important to consider any previously expressed values and preferences, communicated directly by the patient or via their medical decision treatment maker.

ICU Liaison Services consist of experienced critical care nurses and doctors who provide follow up of patients discharged to the ward from ICU, as well as support for medical and nursing staff caring for deteriorating patients on the ward. The ICU Liaison service may be able to regularly review and manage COVID-19 positive patients on the ward and update the ICU team of their progress or deterioration, in order to streamline their admission to ICU if required, and prevent unnecessary ICU admissions in times of increased demand.

The clinical features that prompt consideration of ICU admission are those of severe or critical illness: respiratory failure, shock and multiple organ dysfunction (see Table 2).

**Table 2. Clinical features of COVID-19 patients prompting consideration of ICU admission**

<b>Respiratory</b>	<ul style="list-style-type: none"> <li>Hypoxaemia (requiring <math>&gt; 6\text{L O}_2</math> via nasal prongs to achieve <math>\text{SpO}_2 &gt; 92\%</math>, or arterial partial pressure of oxygen (PaO<sub>2</sub>) / inspired oxygen fraction (FiO<sub>2</sub>) <math>\leq 300</math>).</li> <li>Respiratory distress or increased work of breathing (respiratory rate <math>&gt; 30</math> breaths/minute).</li> <li>Patient deterioration despite advanced respiratory support (via either non-invasive ventilation (NIV) or high flow nasal oxygen).</li> <li>Worsening lung infiltrates on chest radiograph.</li> </ul>
<b>Cardiovascular</b>	<ul style="list-style-type: none"> <li>Systolic blood pressure <math>&lt; 90\text{mmHg}</math>.</li> <li>Heart rate <math>&gt; 120</math> beats per minute.</li> </ul>
<b>Neurological</b>	<ul style="list-style-type: none"> <li>Altered conscious state.</li> </ul>
<b>Other</b>	<ul style="list-style-type: none"> <li>Deteriorating multiple organ function.</li> </ul>

## MANAGEMENT

### General ICU management

#### Fluid management

Notwithstanding initial resuscitation requirements, severe and critically unwell COVID-19 patients in ICU should be managed with a conservative fluid approach, aiming for relative euvolaemia. Fluid should be administered cautiously as patients with severe and critical COVID-19 may develop myocardial dysfunction, with the attendant risks of acute pulmonary oedema.

#### Thromboprophylaxis

Studies have suggested that there is an increased risk of thromboembolism associated with COVID-19 infection<sup>10</sup>. Australian guidelines recommend the use of higher doses of prophylactic anticoagulants in adults with severe or critical COVID-19 infection (for example, enoxaparin 40mg twice daily for patients with normal renal function, or once daily in those with impaired renal function), unless there is a contraindication, such as major bleeding or thrombocytopenia<sup>6</sup>.

#### Antimicrobials

Given the difficulty in distinguishing bacterial pneumonia or coinfection from COVID-19 alone, it is appropriate for suspected or confirmed COVID-19 patients with an oxygen requirement to be managed empirically with broad-spectrum antimicrobials with activity against both typical and atypical respiratory pathogens. This should be reviewed daily and de-escalated as able, depending on the patient’s clinical picture and the available microbiology.

#### Sedation and analgesia

Requirements for sedation and analgesia in intubated COVID-19 patients vary. Generally, a Richmond Agitation Sedation Score (RASS) of 0 to -2 can be targeted, unless there is evidence of ventilator dyssynchrony or a requirement for neuromuscular blockade (such as in critical hypoxemia), in which case deeper sedation may be required. Deeper sedation may also be required for patients at risk of self-extubating. Agents used for sedation include, but are not limited to, propofol, opioids such as fentanyl and benzodiazepines such as midazolam. Dexmedetomidine may be appropriate in the weaning stages for selected patients, especially in the setting of delirium.

#### Other

Usual ICU supportive management includes stress ulcer prophylaxis and glycaemic control as per local protocols, bowel management and strict pressure injury care. Discussion regarding goals of care should be done early in patients’ hospital admission with consideration of their values and preferences and in conjunction with their family and/or next-of-kin.

### Advanced life support

Cardiopulmonary resuscitation is a complex and difficult problem in patients with COVID-19 pneumonia and is considered aerosol generating. It is important for institutions to develop internal protocols for the performance of advanced life support (ALS) with modification to algorithms and the use of personal protective equipment (PPE) both in patients with known COVID infection as well as in general hospital inpatients during periods of high community transmission. It is important to monitor patients with COVID-19 infection who are at risk of deterioration in higher acuity areas of the hospital, as well as have clearly documented “goals of care” (that is, intubation/resuscitation status) for such patients to ensure appropriate decisions are made.

Staff safety remains a core priority during ALS. It is important that the hospital has appropriate PPE for staff safety and that it is worn prior to commencing cardiopulmonary resuscitation (CPR) or entering a negative pressure room (NPR). In the presence of community transmission of COVID-19, an unresponsive or collapsed patient must be assumed to be high risk for COVID-19 infection, and therefore, healthcare workers (HCW) must only proceed with resuscitative measures if they are in the appropriate PPE. Having a buddy system, or “PPE spotter” to allow appropriate donning and doffing and restricting the number of staff entering the room can help with this.

Recommended modifications to the ALS algorithm are listed in Table 3.

**Table 3. Recommended modifications to the ALS algorithm<sup>11</sup>**

General
<ul style="list-style-type: none"> <li>All HCWs performing resuscitative measures should be dressed in PPE for full airborne precautions (for example, gloves, eye protection, gown, N95 mask or powered air-purifying respirator (PAPR)).</li> <li>Staff should wear a minimum of gloves, eye protection, and surgical face mask before placing defibrillation pads on the chest, performing a rhythm check and defibrillating a patient.</li> <li>If able, resuscitation should be performed in the highest level of isolation room or area available.</li> </ul>
Airway and breathing
<ul style="list-style-type: none"> <li>Use a mask, towel or sheet to cover the patient’s face to reduce the risk of aerosols during resuscitation.</li> <li>Provide oxygen via a face mask only. If possible, a supraglottic airway is preferred to a face mask.</li> <li>Place a hand on the patient’s chest to feel for chest rise and fall. Do not listen or feel for breathing.</li> <li>Use head tilt or chin lift only in order to clear the airway.</li> <li>Do not suction an airway with an open device (that is, Yankauer sucker) unless in an appropriate room with airborne PPE.</li> <li>Early intubation via an experienced airway operator, using video laryngoscope</li> <li>Minimise bag-mask ventilation. Perform positive pressure ventilation ideally only once the patient is intubated, with cuff up and the ETT position is confirmed.</li> </ul>
Circulation
<ul style="list-style-type: none"> <li>Perform compression-only CPR until an endotracheal tube is inserted.</li> <li>Do not disconnect airway devices for defibrillation.</li> <li>Use mechanical CPR devices if available to reduce HCW exposure to COVID-19.</li> </ul>

### Psychological support to patients, families and staff

Staff wellbeing and support is vital in a pandemic in order to protect them and create a safe and sustainable workforce. Increased workload, feelings of stress, anxiety and uncertainty are common. Prioritise clear, consistent communication and education for all staff. Regularly monitor staff wellbeing and ensure staff know how to access mental health and psychological support services. Ensure appropriate rostering and shift breaks and encourage time off work to avoid burn out. Provide rest areas with adequate social distancing measures in place. Ensure adequate and appropriate PPE is available for all staff caring for COVID-19 patients, including the use of PPE buddies. Assign high-risk staff (including those aged over 65 years, pregnant or immunocompromised) to patients who are confirmed COVID-19 negative.

Establish a communication plan with families. If visitation is restricted or denied, provide frequent, scheduled phone or video updates. Consider appropriateness of more lenient visitation during certain circumstances such as end-of-life care, in conjunction with local hospital guidelines. Utilise telephone or video calls for patients in order to enhance communication between themselves, their families and social supports.

### Oxygenation and ventilation of COVID-19 patients

#### Oxygenation strategy

Severe and critical COVID-19 patients appear to suffer more from hypoxia than hypercapnia (Type 1 respiratory failure) despite extensive pulmonary inflammatory changes.

The WHO has recommended targeting oxygen saturations (SpO<sub>2</sub>) greater than 96 per cent on initial resuscitation and greater than 90 per cent on subsequent resuscitation<sup>12</sup>. This should be achieved with the lowest FiO<sub>2</sub> possible and ideally via a low flow system (either face mask or nasal prong oxygen) with a designated limit for ward-based care (such as 6 L/min). This will allow recognition of deterioration along with minimising the risk of droplet aerosolisation and risk to patients and staff.

Patients with COVID pneumonia can vary in severity of pulmonary involvement. There is a spectrum of disease ranging from mild to severe. The management can thus range from observation, to low-flow oxygen, to high-flow or non-invasive ventilation and ultimately intubation and mechanical ventilation. Given both the infectivity of the disease and that patients’ clinical conditions can change rapidly, it is important for hospitals to develop clear guidelines and protocols to manage these patients during the course of their stay.

#### High flow nasal cannula oxygen and non-invasive ventilation

The appropriate modality to oxygenate patients who are deteriorating despite low level oxygen support is challenging and is constantly evolving. In an early report of the first 1591 patients admitted to ICU in 72 hospitals in the Lombardy region, 88 per cent were intubated<sup>13</sup>. However, intubating all patients who are failing low flow oxygenation may lead to both some unnecessary intubations and will impact resource utilisation within the hospital.

If a patient remains hypoxaemic despite increasing FiO<sub>2</sub>, positive end-expiratory pressure (PEEP) may be indicated. Continuous positive airway pressure (CPAP) can be used with suggested pressure ranges of 8-14 cmH<sub>2</sub>O, although the level may need to be adjusted as clinically indicated<sup>14</sup>.

The use of high flow nasal prong (HFNP) oxygen and non-invasive ventilation (NIV) is challenging as they are considered AGPs and so pose a potential risk to staff and other patients. Institutions with NPRs or single isolation rooms may be able to use this modality more frequently but it remains problematic in open-plan areas. NIV and HFNP oxygen may be limited to respiratory isolation rooms on the ward or in the ICU when provided under infection control devices such as the “McMonty Hood” (see section on infection control).

All patients who are undergoing HFNP oxygen therapy need increased monitoring in a high-acuity (HDU or ICU) environment due to the potential for rapid deterioration and the need for urgent intubation. Similarly, strict attention to PPE regardless of the location of these patients is critical.

#### Self proning

Proning is an established mechanism for improving oxygenation in patients with refractory type 1 respiratory failure by minimising ventilation/perfusion mismatch in the lung<sup>15</sup>. Self-proning in awake COVID-19 patients prior to intubation was initially reported in a single centre French study that described 24 spontaneously ventilating hypoxic patients with posterior lesions on chest CT<sup>16</sup>. Of these patients, 63 per cent were able to tolerate this for more than three hours, although oxygenation increased in only 25 per cent. Given the small data-sets and complexities with nursing care of these patients, individual hospitals need to determine their own protocols as to whether they should implement this strategy.

#### Intubation

The decision to intubate a patient with COVID pneumonia remains challenging. Waiting until a patient is in extremis puts both patients and staff at risk in terms of both outcomes and infection. “Early” intubation has been recommended but this is challenging both because the definition of what “early” means is debated and because there is a subset of patients with COVID-19 pneumonia who remain relatively stable despite high levels of supplemental oxygen therapy for many days.

Consideration for intubation may include rapid deterioration over hours, inability to maintain oxygen saturations greater than 90 per cent with an FiO<sub>2</sub> of 0.6 or higher, hypercapnoea, increasing work of breathing, haemodynamic instability and multi-organ failure.

Intubation is considered an AGP and so ideally should be performed in a NPR by the most experienced practitioner available<sup>17</sup>. Staff protection remains a key priority even in the context of significant patient deterioration and as such, early planning and identification of patients potentially needing intubation is of critical importance.

Some institutions utilise “airway teams”, often including senior intensivists and anaesthetists, to intubate suspected or confirmed COVID-19 patients. Simulation, education and clear protocols are helpful given the stressful nature of intubating critically unwell and infective patients in often unfamiliar environments, including the use of cognitive aids, and outside and inside room checklists. These serve as reminders for the team leader of the critical steps involved in the intubation process. If a NPR is available for intubations, it can be beneficial to create two different teams – one team as the primary intubators and a second team in the antechamber to allow rapid communication and equipment management.

Intubation and equipment checklists consistent with society guidelines should be created, printed out in high colour and laminated to provide visual guidance and to help create consistency of approach.

Adjustments need to be made to multiple pieces of equipment to allow safe intubation in patients with COVID-19 pneumonia. With face mask ventilation, the circuit should be modified so that a viral filter is connected directly to the face mask to minimise the risk of infectious aerosolisation.

The ventilator should also be set up prior to intubation with pre-specified settings. The circuit for connection should be modified to include closed system suctioning. Once intubation has been confirmed and the patient transferred to the ventilator, a decision needs to be made as to whether to keep end tidal carbon dioxide monitoring in place. This is normally considered a routine part of care of the intubated patient, but the risk of aerosolisation may mean that some institutions decide to leave it out.

A modified rapid sequence induction (RSI) approach is used for intubation. Modifications may include two handgrip mask oxygenation to minimise gas leak, extended pre-oxygenation time up to five minutes, use of a large dose of paralytic agent, avoidance of routine cricoid pressure, avoidance of bag mask ventilation unless life threatening hypoxaemia develops, using video-laryngoscopy to optimise view for first pass intubation and confirmation of cuff up on the pilot balloon prior to commencing ventilation.

A structured approach to then transition the patient to the ventilator is also required to minimise risks to patient and staff. This may include turning off the oxygen at the wall to the self-inflating bag, clamping the endotracheal tube (ETT) prior to disconnection, connecting the patient to the ventilator, unclamping the ETT and then commencing ventilation.

Clear communication is required between all team members throughout this process. Depending on local resources it may be prudent to then protocolise the insertion of nasogastric (NG) tubes or central venous catheters (CVCs) in addition to the timing of being able to leave the NPR.

### Ventilation strategy

The approach to ventilation in patients with COVID pneumonia follows a similar approach to ventilation in ARDS. On commencement of ventilation, a routine mode of mechanical ventilation should be chosen to allow uniformity of practice. For example, synchronised intermittent mandatory ventilation mode, with a tidal volume of 4-8mls per kilogram ideal body weight, a plateau pressure target of less than 30cmH<sub>2</sub>O, a respiratory rate of 20 and an IE ratio of 1:2.

Default ventilation targets should also be aimed for in the patient that may include saturations of greater than 88 per cent, a partial pressure of oxygen (pO<sub>2</sub>) greater than 55-60mmHg and acceptance of hypercapnoea.

The approach to maintaining ventilation may include plateau pressures of less than 30-32cmH<sub>2</sub>O with tidal volumes of 4-8mls/kg. The use of PEEP-FiO<sub>2</sub> tables can be used in this patient group and a higher PEEP strategy is recommended<sup>18</sup>. Other changes to routine ventilation include using closed in-line suction catheters, avoidance of nebulised medications and not routinely performing bronchoscopy (all designed to minimise aerosol generation).

In the setting of refractory hypoxaemia, a structured approach should be taken including reassessing the patient for any reversible causes of the deterioration (such as sputum, ventilator associated pneumonia, pneumothorax or cardiac failure) and then a sequential series of management strategies such as neuromuscular blockade (either as a bolus dose of infusion), diuresis, recruitment manoeuvres and the consideration of prone positioning.

In settings of refractory hypoxaemia despite these measures, consideration may be made for extracorporeal membrane oxygenation (ECMO) although this is a resource intensive strategy, has limited data in COVID-19 pneumonia and is not widely available.

### Prone

Prone position ventilation has been used in severe COVID pneumonia with refractory hypoxaemia. The indications for prone include a PF ratio of < 150 with an FiO<sub>2</sub> > 0.6 with a PEEP > 5cmH<sub>2</sub>O with a tidal volume of around 6ml/kg. Prone is most effective in units that are familiar with the technique and practice it routinely. Unit protocols, a team-based approach and regular simulation are required in order for this to be successful. Patients should be placed in the prone position for approximately 16 hours per day.

### Extubation

Ideally, extubation should be performed when the patient is deemed to no longer be infective, and in this instance, standard extubation procedures can be followed.

Timing of extubation of patients still infective with COVID-19 should be carefully assessed to decrease any chance of failure, or of the patient requiring NIV or re-intubation. They should ideally be ready to extubate onto a facemask.

Readiness for extubation should be assessed via standard protocols, including the use of a spontaneous breathing trial (SBT)<sup>19</sup>. COVID-19 patients are often intubated for longer periods than non-COVID patients with evidence suggesting increased airway oedema and secretions<sup>20</sup>. Consider using lower pressure support ventilation (PSV) parameters (for example, 0-5cm H<sub>2</sub>O instead of 5-10cm H<sub>2</sub>O) and for a longer period of time to ensure a higher degree of readiness.

Consider the use of prophylactic corticosteroids in the 24-28 hours prior to planned extubation of patients with prolonged intubations to decrease laryngeal oedema.

Extubation is an AGP and for a patient who is still infective, this should be performed in a NPR with appropriate PPE for droplet and contact precautions (including gown, gloves, N95 mask and eye protection), or under a McMonty/Ventilation Hood. Minimise the number of staff in the room, with staff available outside should they be needed, including senior staff who are trained to re-intubate if required.

Assessing for a cuff leak prior to extubation is not recommended due to its potentially poor positive predictive value and sensitivity, and the potential to generate aerosolised particles<sup>21</sup>.

Consider mechanisms to minimise the risk of coughing, including intravenous opioids or dexmedetomidine and care during oral suctioning.

Once extubated, place an oxygen mask over the face and do not encourage patients to cough afterwards. The patient should remain in the NPR for 30-60 minutes following extubation to allow for clearance of aerosolised particles, however the ideal time for this is still unclear and a balance must be found between staff and patient safety, and hospital efficiency.

### Tracheostomy

Patients with COVID pneumonia often have prolonged ICU stays and slow ventilatory weans. Tracheostomy may be required to facilitate weaning from mechanical ventilation. There is no specific evidence guiding the timing of tracheostomy and the decision to proceed with the procedure needs to balance the risks of staff with the potential benefit to the patient. Current ANZICS guidelines recommend waiting until day 10 of intubation prior to consideration of tracheostomy insertion. The tracheostomy procedure is aerosol generating and so strict protocols for performing it with appropriate PPE are required.

### COVID-19-specific management

#### Antiviral therapy – remdesivir

Remdesivir is an RNA polymerase inhibitor which has been shown to shorten the time to recovery and reduce the risk of death in adults hospitalised with COVID-19 infection and with evidence of lower respiratory tract infection<sup>22</sup>.

Australian guidelines recommend consideration of treatment with remdesivir for five days for ICU patients with moderate to severe COVID-19 infection who do not require ventilation (invasive, non-invasive or extra-corporeal membrane oxygenation (ECMO))<sup>6</sup>.

#### Antiviral therapy – baricitinib

Baricitinib is an orally administered selective inhibitor of Janus Kinase 1 and 2. It inhibits the intracellular signalling pathways of cytokines known to be elevated in severe COVID-19<sup>23</sup>. Baricitinib plus remdesivir has been shown to be superior to remdesivir alone in reducing recovery time and accelerating clinical status among patients with COVID-19. Australian guidelines currently recommend using baricitinib (4mg oral or nasogastric daily dose for up to 14 days) in adults who require supplemental oxygen particularly where there is evidence of systemic inflammation<sup>6</sup>.

### Corticosteroids

Corticosteroids may have activity against the associated cytokine-release syndrome seen in severe and critical COVID-19 illness<sup>24</sup>. Evidence suggests there may be a mortality benefit with the use of dexamethasone for patients hospitalised with COVID-19 who required supplemental oxygen or additional supports, by modulating inflammation-mediated lung injury and thereby reducing progression to respiratory failure and death<sup>25</sup>.

Australian guidelines recommend using dexamethasone 6mg daily intravenously or orally for up to 10 days in adults with COVID-19 who are receiving supplemental oxygen (including mechanically ventilated patients). If dexamethasone is unavailable, alternative acceptable options include hydrocortisone, prednisolone or methylprednisolone<sup>6</sup>.

### Immunotherapy

Immunotherapy may help modulate the effects of the cytokine storm seen in some patients with severe COVID-19 infection<sup>26</sup>. For adults with COVID-19 who require supplemental oxygen, especially those with evidence of systemic inflammation, tocilizumab or sarilumab may reduce the risk of death, however, the RECOVERY and REMAP-CAP trials showed benefit when tocilizumab was used in conjunction with corticosteroids for this subset of patients<sup>25,27</sup>.

### Others

Minimal evidence supports the use of aspirin, azithromycin, colchicine, convalescent plasma, hydrochloroquine, interferon  $\beta$ -1a or lopinavir-ritonavir in the treatment of adults with COVID-19 and this is not recommended. There are a number of other agents and experimental therapies that are also not recommended for use outside of clinical trials, and expert guidance from local and international societies is recommended (see Table 4).

**Table 4. Disease-modifying treatments not recommended outside of clinical trials for patients with severe to critical COVID-19\***

<p>Antiandrogens</p> <ul style="list-style-type: none"> <li>Dutasteride</li> </ul> <p>Antineoplastics</p> <ul style="list-style-type: none"> <li>Angiotensin 2 receptor agonist (C21)</li> <li>Camostat mesilate</li> </ul> <p>Antiparasitic, antifungals and other anti-infective agents</p> <ul style="list-style-type: none"> <li>Chloroquine</li> <li>Doxycycline</li> <li>Ivermectin</li> <li>Ivermectin plus doxycycline</li> <li>Nitazoxanide</li> </ul> <p>Antihypertensives</p> <ul style="list-style-type: none"> <li>Telmisartan</li> </ul> <p>Antithrombotic, antiplatelets and related therapies</p> <ul style="list-style-type: none"> <li>Sulodexide</li> </ul> <p>Antivirals</p> <ul style="list-style-type: none"> <li>Baloxavir marboxil</li> <li>Darunavir-cobicistat</li> <li>Enisamium</li> <li>Favipiravir</li> <li>Sofosbuvir-daclatasvir</li> <li>Triazavirin</li> <li>Umifenovir</li> </ul> <p>Human and blood derived products</p> <ul style="list-style-type: none"> <li>Human umbilical cord mesenchymal stem cells</li> <li>Intravenous immunoglobulin</li> <li>Intravenous immunoglobulin plus methylprednisolone</li> </ul>	<p>Immunomodulating drugs</p> <ul style="list-style-type: none"> <li>Anakinra</li> <li>Lenzilumab</li> <li>Ruxolitinib</li> <li>Tofacitinib</li> </ul> <p>Interferons</p> <ul style="list-style-type: none"> <li>Interferon <math>\beta</math>-1a (inhaled)</li> <li>Interferon <math>\beta</math>-1b</li> <li>Interferon gamma</li> <li>Interferon kappa plus trefoil factor 2 (IFN-<math>\kappa</math> plus TFF2)</li> <li>Peginterferon lambda</li> </ul> <p>Other antibody related therapies</p> <ul style="list-style-type: none"> <li>Bamlanivimab</li> <li>Bamlanivimab plus etesevimab</li> <li>Regdanvimab</li> </ul> <p>Other therapies</p> <ul style="list-style-type: none"> <li>Aprepitant</li> <li>Bromhexine hydrochloride</li> <li>Fluvoxamine</li> <li>Recombinant human granulocyte colony-stimulating factor (rhG-CSF)</li> </ul> <p>Vitamins, supplements and cofactors</p> <ul style="list-style-type: none"> <li>Combined metabolic cofactor supplementation (CMCS)</li> <li>N-acetylcysteine</li> <li>Vitamin C</li> <li>Vitamin D analogues (calcifediol/cholecalciferol)</li> <li>Zinc</li> </ul>
--	--

\*National COVID-19 Clinical Evidence Taskforce. Australian Guidelines for the clinical care of people with COVID-19. 2021 [version 44]. Available from: <https://covid19evidence.net.au/>

## INFECTION CONTROL

### COVID-19 Transmission

COVID-19 is extremely transmissible and gains entry through the mucous membranes. There are three main routes of transmission in humans:

1. Direct contact with virus-contaminated fomites on skin, surfaces or other objects.
2. Larger, respiratory droplets.
3. Smaller, micro-droplets or aerosols of virus-containing particles that persist in the environment from human breathing, shouting, singing, coughing or sneezing.

COVID-19 can survive on surfaces for hours to days and in aerosolized droplets for up to three hours<sup>28</sup>. Data from Australia in 2020 suggests that most infected HCWs acquired their infection in the workplace.<sup>17</sup> Therefore, anyone treating confirmed or suspected COVID-19 patients must use the appropriate PPE.

### Aerosol generating procedures

AGPs increase the risk of nosocomial transmission of COVID-19 among HCWs. AGPs include any procedures of the respiratory tract, including tracheal intubation, extubation, tracheostomy, bronchoscopy, suctioning and mouth care. Other high risk AGPs include, nebuliser therapy, high flow nasal oxygen, non-invasive ventilation, transoesophageal echocardiography (TOE) and endoscopy (gastroscopy), as well as chest compressions and defibrillation<sup>29</sup>.

### Protecting staff

To adequately protect staff, appropriate local guidelines, in conjunction with the most up-to-date evidence-based recommendations must be established. These include frequent hand hygiene with alcohol-based hand sanitiser or soap and water, avoidance of touching one's face with contaminated hands, regular disinfection of equipment and surfaces, and practising social distancing. Staff should avoid sharing equipment and minimise personal effects taken into the workplace. Staff must be provided with the appropriate PPE, as well as training and supervision in PPE use.

Steps to maximise staff safety while performing patient interventions include:

- Minimise the number of times each intervention is performed.
- Minimise the time taken to perform the intervention, with the most experienced person available performing the intervention.
- Minimise the number of people at the bedside or in the room where the intervention is being performed.
- Perform AGPs in a NPR or, if unavailable, a single room.

There are a number of measures which can be taken to help reduce staff infection rate and increase staff sustainability (see Table 5).

**Table 5. Reducing staff infection rate and increasing staff sustainability**

<p><b>Single negative pressure isolation rooms for COVID-19 patients</b></p> <ul style="list-style-type: none"> <li>Only perform AGPs in NPRs.</li> <li>Anteroom for donning and doffing PPE.</li> </ul>
<p><b>Single standard pressure isolation rooms for COVID-19 patients</b></p>
<p><b>Clearly designated "COVID-19 areas" for patients in open ICUs</b></p>
<p><b>Minimise HCW contact with suspected and confirmed COVID-19 patients</b></p> <ul style="list-style-type: none"> <li>Single team member to examine patients.</li> <li>Visiting teams to the ICU to send minimum number to see patient, prefer over-the-phone consultation.</li> </ul>
<p><b>Minimise HCW cross-infection with COVID-19</b></p> <ul style="list-style-type: none"> <li>Cancel face-to-face meetings.</li> <li>Social distancing in break rooms.</li> <li>Clean personal equipment, minimise personal effects, wear scrubs in clinical areas that can be changed out of at the end of a shift and shoes that can be readily disinfected.</li> </ul>

### Personal protective equipment

PPE includes hand hygiene, gown, gloves, N95 respirators, face-shields or goggles, and sometimes a powered air-purifying respiratory (PAPR) if clinically appropriate. Different levels of PPE include standard, contact, droplet and airborne precautions<sup>28</sup>.

Contact and airborne PPE precautions are recommended to care for all suspected or confirmed COVID-19 patients in ICU, as well as when assessing suspected or confirmed COVID-19 patients elsewhere in the hospital. Staff training in PPE fitting, compliance and competency is recommended, including “fit testing” of N95 masks and the use of a buddy or “PPE spotter” to supervise and monitor any breaches when donning and doffing PPE. Multidisciplinary staff training and simulation is recommended to improve practise.

### Patient isolation hood

The McMonty patient isolation hood is a portable shielded plastic hood that was developed with the aim of reducing HCW COVID-19 infections<sup>34</sup>. It covers the patient in the hospital bed and has an extractor fan which creates a negative pressure system under the hood that passes through a viral filter. It allows aerosols generated by patients to pass through this viral filter rather than passing into the environment. This is hypothesised to decrease the risk of transmission of COVID-19 both to other patients and to HCWs. The use of novel technologies such as this may be particularly important in ICUs with predominantly open plan environments and minimal NPRs or isolation rooms. It may similarly have roles in emergency departments and ward-based environments. Such novel devices need to undergo trial analysis to confirm their usefulness and units should be encouraged to participate in such trials if they can.

### Vaccines

The global administration of safe and effective vaccines against SARS-CoV-2 are vital to controlling the pandemic. There are three primary vaccines being used in Australia at the time of publication; two messenger RNA (mRNA) vaccines (BNT162b2, Pfizer-BioNTech and mRNA-1273, Moderna), and an adenoviral vector vaccine (ChAdOx1 nCoV-19, Oxford/AstraZeneca). These vaccines have been shown to be highly effective in preventing symptomatic and asymptomatic SARS-CoV-2 infections and COVID-19-related hospitalisations, severe disease and death<sup>30,31</sup>. By late 2021, it became mandated for many Australian industries and workers (including frontline HCWs) to be fully vaccinated to leave home to work on-site. Data from observational studies have suggested the possibility of waning vaccine-elicited immunity and decreased vaccine effectiveness over time<sup>32,33</sup>. Administration of booster doses for certain high-risk individuals in Australia were becoming available at the time of publication.

## ICU PANDEMIC PLANNING

### Staffing and surge capacity

Institutional and regional pandemic planning is essential in order to minimise strain on the healthcare system and maintain the highest standards of staff and patient care.

Pandemic plans must include approaches to reduce ICU demand and increase ICU capacity from both an infrastructure and workforce and staffing point of view. See Table 6<sup>17</sup>.

Sick leave for HCWs, as well as requirements to self-isolate or furlough will lead to staff shortages and have a significant impact on workforce sustainability. Re-deployment of critical care trained staff (for example, anaesthetists) to ICU may be necessary. Also, non-critical care trained staff from medical, nursing and allied health departments may need to assist in ICU under the supervision of trained critical care staff.

Regular and effective communication and information sharing at local, regional and state levels is crucial to the successful delivery of safe and effective clinical services in a pandemic.

Determining risk of ICU admission involves an analysis of local prevalence, cluster epidemiology, rates of new COVID-19 cases and the ability to control community outbreaks.

**Table 6. Measures to reduce ICU demand and increase ICU capacity during a pandemic<sup>17</sup>**

<p><b>Measures to reduce ICU demand during the pandemic</b></p> <ul style="list-style-type: none"> <li>▪ Access to fast COVID-19 testing for ED, ICU and theatre patients.</li> <li>▪ Defer or cancel non-urgent elective surgery.</li> <li>▪ Expedited patient discharge from ICU, including additional support or supervision for ward staff to manage higher acuity patients.</li> <li>▪ Reserving ICU admission for patients requiring ICU-specific interventions, including extended stays in areas such as theatre recovery or CCU.</li> <li>▪ Proactive consideration of treatment goals and documentation of goals-of-care to avoid ICU/HDU admissions in patients who are more appropriately managed on the ward.</li> </ul>
<p><b>Measures to increase ICU capacity (Infrastructure)</b></p> <ul style="list-style-type: none"> <li>▪ Daily discussions between tertiary, metro and regional ICUs to assess clinical strain and resource availability.</li> <li>▪ Transfer patients between ICUs to ensure equitable distribution of patient numbers and workload.</li> <li>▪ Repurpose alternative clinical areas for critical care patients, including CCU, HDU, theatre recovery, or unstaffed or old ICU bays.</li> <li>▪ Assess current stock of ICU equipment and anticipate requirements with increasing ICU load and methods of procuring additional equipment.</li> </ul>
<p><b>Measures to increase ICU capacity (workforce and staffing)</b></p> <ul style="list-style-type: none"> <li>▪ Re-deployment of critical care trained staff (for example, anaesthetists) to ICU.</li> <li>▪ Non-critical care trained staff from medical, nursing and allied health departments may need to assist in ICU under the supervision of trained critical care staff.</li> </ul>

## ICU OUTCOMES

Outcomes specific to patients admitted to ICU have varied widely. The reasons for these significant differences may relate to local resources, ICU admission criteria and definition, diagnostic and treatment capabilities as well as overall case load and hospital strain.

An early single centre study from China showed that of 138 patients with novel coronavirus infected pneumonia, 26 per cent of patients required admission to ICU and 4.3 per cent of patients died<sup>35</sup>. Subsequently, a prospective analysis of 257 critically ill patients admitted to two ICUs in New York reported that 39 per cent had died in hospital with only 23 per cent being discharged alive (the rest remaining hospitalised at the time of publication). At the time of writing, the most recent ICNARC report from the United Kingdom has reported 24,781 patients in total admitted to ICU and outcomes thus far have shown 37.2 per cent have died in ICU<sup>36</sup>. In Australia and New Zealand, 204 patients were admitted to ICUs in the “first wave”, and the mortality of ICU patients who were intubated (22 per cent) was significantly higher than those who were not (5 per cent)<sup>37</sup>.

## CONCLUSION

The global COVID-19 pandemic has produced many challenges to human health and society. The impact on intensive care has been profound and ongoing. The assessment and management of COVID-19 continues to rapidly evolve from a critical care perspective and there is still minimal evidence as to what is optimal management. Ongoing global efforts into research and clinical trials will aid in providing more robust evidence into the potential treatment options for COVID-19. This requires commitment from national, regional and hospital levels.

## REFERENCES

1. Zhu N, Zhang D, Wang W, Li X., Yang B., Song J, et al. A Novel Coronavirus from Patients with Pneumonia in China, 2019. *N Engl J Med.* 2020;382(8):727-733. doi:10.1056/NEJMoa2001017
2. Li Q, Guan X, Wu P, Wang X, Zhou L, Tong Y, et al. Early Transmission Dynamics in Wuhan, China, of Novel Coronavirus-Infected Pneumonia. *N Engl J Med.* 2020;382(13):1199-1207. doi:10.1056/NEJMoa2001316
3. Phua J, Weng L, Ling L, Egi M, Lim CM, Divatia JV, et al. Intensive care management of coronavirus disease 2019 (COVID-19): challenges and recommendations. *Lancet Respir Med.* 2020;8(5):506-517. doi:10.1016/S2213-2600(20)30161-2



4. Young BE, Ong SWX, Kalimuddin S, Low JG, Tan SY, Loh J, et al. Epidemiologic Features and Clinical Course of Patients Infected with SARS-CoV-2 in Singapore. *JAMA - J Am Med Assoc.* 2020;323(15):1488–94.
5. Zhou F, Yu T, Du R, Fan G, Liu Y, Liu Z, et al. Clinical course and risk factors for mortality of adult inpatients with COVID-19 in Wuhan, China: a retrospective cohort study. *Lancet [Internet].* 2020;395(10229):1054–62. Available from: [http://dx.doi.org/10.1016/S0140-6736\(20\)30566-3](http://dx.doi.org/10.1016/S0140-6736(20)30566-3)
6. Australian National COVID-19 Clinical Evidence Taskforce. Australian guidelines for the clinical care of people with COVID-19. 2020 [version 36]. Available from: <https://covid19evidence.net.au/>. Accessed May 1, 2021.
7. Rodriguez-Morales AJ, Cardona-Ospina JA, Gutiérrez-Ocampo E, Villamizar-Peña R, Holguin-Rivera Y, Escalera-Antezana JP, et al. Clinical, laboratory and imaging features of COVID-19: A systematic review and meta-analysis. *Travel Med Infect Dis.* 2020 Mar-Apr;34:101623. doi: 10.1016/j.tmaid.2020.101623.
8. Cron RQ, Chatham WW. The Rheumatologist's Role in Covid-19. *J Rheumatol [Internet].* 2020 Mar 24;jrheum.200334. Available from: <http://www.jrheum.org/content/early/2020/03/24/jrheum.200334.abstract>
9. Carubbi F, Salvati L, Alunno A, Maggi F, Borghi E, Mariani R, et al. Ferritin is associated with the severity of lung involvement but not with worse prognosis in patients with COVID-19: data from two Italian COVID-19 units. *Sci Rep [Internet].* 2021;11(1):1–11. Available from: <https://doi.org/10.1038/s41598-021-83831-8>
10. Malas MB, Naazie IN, Elsayed N, Mathlouthi A, Marmor R, Clary B. Thromboembolism risk of COVID-19 is high and associated with a higher risk of mortality: A systematic review and meta-analysis. *EClinicalMedicine.* 2020 Dec;29:100639. doi: 10.1016/j.eclinm.2020.100639.
11. Australasian College for Emergency Medicine: Adult Cardiac Arrest Management. Available from: <https://acem.org.au/Content-Sources/Advancing-Emergency-Medicine/COVID-19/Resources/Clinical-Guidelines/Adult-Cardiac-Arrest-Management>. Accessed May 1, 2021.
12. World Health Organisation (WHO): Clinical management of severe acute respiratory infection when novel coronavirus (nCoV) infection is suspected. [https://www.who.int/csr/disease/coronavirus\\_infections/InterimGuidance\\_ClinicalManagement\\_NovelCoronavirus\\_11Feb13u.pdf](https://www.who.int/csr/disease/coronavirus_infections/InterimGuidance_ClinicalManagement_NovelCoronavirus_11Feb13u.pdf). Accessed on April 30, 2021.
13. Grasselli G, Zangrillo A, Zanella A, Antonelli M, Cabrini L, Castelli A, et al. Baseline Characteristics and Outcomes of 1591 Patients Infected With SARS-CoV-2 Admitted to ICUs of the Lombardy Region, Italy. *JAMA.* 2020;323(16):1574–1581. doi:10.1001/jama.2020.5394
14. Nicholson TW, Talbot NP, Nickol A, Chadwick AJ, Lawton O. Respiratory failure and non-invasive respiratory support during the covid-19 pandemic: an update for re-deployed hospital doctors and primary care physicians. *BMJ.* 2020;369:m2446. doi:10.1136/bmj.m2446
15. Guérin C, Reignier J, Richard JC, Beuret P, Gacouin A, Boulain T, et al. Prone positioning in severe acute respiratory distress syndrome. *N Engl J Med.* 2013;368(23):2159–2168. doi:10.1056/NEJMoa1214103
16. Elharrar X, Trigui Y, Dols AM, Touchon F, Martinez S, Prud'homme E, et al. Use of Prone Positioning in Nonintubated Patients With COVID-19 and Hypoxemic Acute Respiratory Failure. *JAMA.* 2020;323(22):2336–2338. doi:10.1001/jama.2020.8255
17. Australian and New Zealand Intensive Care Society (2020) ANZICS COVID-19 Guidelines, Version 3. Melbourne: ANZICS. Available from: [https://www.anzics.com.au/wp-content/uploads/2020/10/ANZICS-COVID-19-Guidelines\\_V3.pdf](https://www.anzics.com.au/wp-content/uploads/2020/10/ANZICS-COVID-19-Guidelines_V3.pdf). Accessed on May 1, 2021.
18. Acute Respiratory Distress Syndrome Network, Brower RG, Matthay MA, Morris A, Schoenfeld D, Thompson BT, Wheeler A. Ventilation with lower tidal volumes as compared with traditional tidal volumes for acute lung injury and the acute respiratory distress syndrome. *N Engl J Med.* 2000;342(18):1301–1308. doi:10.1056/NEJM200005043421801
19. Brewster DJ, Chrimes NC, Do TBT, et al. Consensus statement: Safe Airway Society principles of airway management and tracheal intubation specific to the COVID-19 adult patient group. *Med J Aust* 2020; <https://www.mja.com.au/journal/2020/consensus-statement-safe-airway-society-principles-airway-management-and-tracheal> [Preprint, 1 April 2020].
20. McGrath BA, Wallace S, Goswamy J. Laryngeal oedema associated with COVID-19 complicating airway management. *Anaesthesia.* 2020;75(7):972.
21. Moran J V, Godil SA, Goldner B, Godil K, Aslam J. Post-Extubation Stridor Complicating COVID-19-Associated Acute Respiratory Distress Syndrome: A Case Series. *Cureus.* 2020;12(9).
22. Beigel JH, Tomashek KM, Dodd LE, Mehta AK, Zingman BS, Kalil AC, et al. Remdesivir for the Treatment of Covid-19 — Final Report. *N Engl J Med.* 2020;383(19):1813–26.
23. Kalil AC, Patterson TF, Mehta AK, et al. Baricitinib plus Remdesivir for Hospitalized Adults with Covid-19. *N Engl J Med.* 2021;384(9):795–807. doi:10.1056/NEJMoa2031994
24. Rochwerg B, Siemieniuk RA, Agoritsas T, Lamontagne F, Askie L, Lytvyn L, et al. A living WHO guideline on drugs for covid-19. *BMJ.* 2020;370:1–14. doi:10.1136/bmj.m3379
25. RECOVERY Collaborative Group, Horby P, Lim WS, Emberson JR, Mafham M, Bell JL, Linsell L, et al. Dexamethasone in Hospitalized Patients with Covid-19. *N Engl J Med.* 2021 Feb 25;384(8):693–704. Available from: <https://doi.org/10.1056/NEJMoa2021436>
26. Mehta P, McAuley DF, Brown M, Sanchez E, Tattersall RS, Manson JJ; HLH Across Speciality Collaboration, UK. COVID-19: consider cytokine storm syndromes and immunosuppression. *Lancet.* 2020 Mar 28;395(10229):1033–1034. doi: 10.1016/S0140-6736(20)30628-0.
27. Angus DC, Berry S, Lewis RJ, Al-Beidh F, Arabi Y, van Bentum-Puijk W, et al. The REMAP-CAP (Randomized Embedded Multifactorial Adaptive Platform for Community-acquired Pneumonia) Study. Rationale and Design. *Ann Am Thorac Soc [Internet].* 2020 Apr 8;17(7):879–91. Available from: <https://doi.org/10.1513/AnnalsATS.202003-192SD>
28. Woolley K, Smith R, Arumugam S. Personal Protective Equipment (PPE) Guidelines, adaptations and lessons during the COVID-19 pandemic. *Ethics Med Public Health.* 2020 Jul-Sep;14:100546. doi: 10.1016/j.jemep.2020.100546.
29. Rahman HS, Aziz MS, Hussein RH, Othman HH, Salih Omer SH, Khalid ES, et al. The transmission modes and sources of COVID-19: A systematic review. *Int J Surg Open.* 2020;26:125–36.

30. Haas EJ, Angulo FJ, McLaughlin JM, et al. Impact and effectiveness of mRNA BNT162b2 vaccine against SARS-CoV-2 infections and COVID-19 cases, hospitalisations, and deaths following a nationwide vaccination campaign in Israel: an observational study using national surveillance data *Lancet.* 2021;397(10287):1819–1829. doi:10.1016/S0140-6736(21)00947-8.
31. Lopez Bernal J, Andrews N, Gower C, et al. Effectiveness of the Pfizer-BioNTech and Oxford-AstraZeneca vaccines on covid-19 related symptoms, hospital admissions, and mortality in older adults in England: test negative case-control study. *BMJ.* 2021;373:n1088. doi:10.1136/bmj.n1088
32. Bar-On YM, Goldberg Y, Mandel M, et al. Protection of BNT162b2 Vaccine Booster against Covid-19 in Israel. *NEJM.* 2021;385(15):1393–1400. doi:10.1056/NEJMoa2114255.
33. Barda N, Dagan N, Cohen C, et al. Effectiveness of a third dose of the BNT162b2 mRNA COVID-19 vaccine for preventing severe outcomes in Israel: an observational study. *Lancet.* Published online October 29, 2021. [https://doi.org/10.1016/S0140-6736\(21\)02249-2](https://doi.org/10.1016/S0140-6736(21)02249-2).
34. McGain F, Humphries RS, Lee JH, Schofield R, French C, Keywood MD, et al. Aerosol generation related to respiratory interventions and the effectiveness of a personal ventilation hood. *Crit Care Resusc.* 2020 May 26. Epub ahead of print. PMID: 32475101.
35. Wang D, Hu B, Hu C, Zhu F, Liu X, Zhang J, et al. Clinical Characteristics of 138 Hospitalized Patients With 2019 Novel Coronavirus-Infected Pneumonia in Wuhan, China *JAMA.* 2020;323(11):1061–1069. doi:10.1001/jama.2020.1585
36. ICNARC report on COVID-19 in critical care: Northern Ireland 26 March 2021. <https://www.icnarc.org/Our-Audit/Audits/Cmp/Reports> (Accessed April 30, 2021)
37. Burrell AJ, Pellegrini B, Salimi F, Begum H, Broadley T, Campbell LT, et al. Outcomes for patients with COVID-19 admitted to Australian intensive care units during the first four months of the pandemic. *Med J Aust.* 2021;214(1):23–30. doi:10.5694/mja2.50883

## Open-source hardware and the great ventilator rush of 2020

### Erich B Schulz, MBBS, MBA, FANZCA

Senior Staff Specialist, Department of Anaesthesia, Mater Health, Brisbane, Queensland, Australia

Dr Schulz has previously practiced medical informatics and was once an accidental medical administrator.

### Robert L Read, PhD

Public Invention, Austin, Texas, USA; founded the non-profit organisation Public Invention in 2018

Dr Read is a professional computer programmer and manager, and amateur mathematician and electrical engineer.

### Ben Coombs, ME(Hons)

Public Invention, Auckland, New Zealand

Mr Coombs holds a Master of Engineering (Honours) in mechanical engineering from The University of Auckland, New Zealand where he researched sustainable aerospace composite materials and manufacturing methods. He is a professional software engineer and has been involved in open-source respiration engineering since the start of the pandemic.

## INTRODUCTION

In early March of 2020, the COVID-19 pandemic exploded into a global concern and triggered a scramble to secure more ventilators<sup>1</sup>. China had largely brought COVID-19 under control but the disease was spreading rapidly. Knowledge and treatment rapidly evolved, and many nations began implementing lock-downs and social distancing. In Lombardy, Italy, ICU capacity was exceeded and mortality rose<sup>2</sup>. Based on understanding of the viral transmissivity and initial treatment protocols, models predicted a world-wide shortfall of intensive care beds and mechanical ventilators<sup>3</sup>. Fears of spreading infection and questionable efficacy resulted in a reluctance to use non-invasive ventilation strategies<sup>4,5,6</sup>.

Australian government modelling<sup>7</sup> predicted that uncontrolled spread of COVID-19 could result in a peak demand of 35,000 ICU beds, or five times the existing capacity. Some models predicted that the USA alone would require up to one million ventilators<sup>3</sup> from a baseline of around 150,000<sup>8</sup>. As the medical community began to seriously consider the prospect of rationing access to ventilators<sup>9,10</sup>, journalists<sup>11,12</sup> picked up the story. Hospitals began to scramble for supplies<sup>13-15</sup>, governments put out urgent calls to industry<sup>16-19</sup> and some institutions<sup>20</sup>, controversially<sup>21,22</sup>, shared a single ventilator with multiple patients.

The availability of ventilators, and the staff to support them, appeared even more precarious in less resourced healthcare systems<sup>23,24</sup> with the prospect of help from wealthy nations seeming remote. Even well-resourced systems investigated the use of veterinary<sup>25</sup> anaesthetic and transport ventilators to support ICU<sup>26,27</sup>. Around the world governments rapidly adopted new and more flexible approaches to emergency use authorisation for devices capable of positive pressure ventilation. Government personnel reached out to engineers for advice, often on a personal and informal basis. The United States Food and Drug Administration (FDA; March 13)<sup>28</sup>, UK government (March 18)<sup>29</sup> and the Australian Therapeutic Goods Administration (TGA; April 7), provided waivers<sup>30</sup> or clarification<sup>31</sup> to existing guidelines. The UK "Specification for Rapidly Manufactured Ventilator System (RMVS)"<sup>29</sup> acted as a foundation for many teams.

By April there were real concerns that industry was going to be incapable of delivering the hardware that the hospitals were going to need<sup>13,14</sup>. Engineers and makers spanning the globe sprang into action<sup>32</sup>. While much of this effort is opaque and unpublished, subject to concerns for intellectual property and corporate interest, there was an explosion of interest in open-source approaches to ventilators<sup>33,34</sup> and other pandemic associated hardware<sup>13</sup>. Competitions were initiated<sup>35</sup>. In excess of 100 open-source teams responded to the perceived emergency<sup>36</sup>.

However, as the pandemic unfolded it became apparent that the demand was not going to reach predictions, despite many countries suffering multiple waves of infection. By late April initial worst-case estimates were being wound down<sup>37</sup>, and by August the perceived ventilator shortage was essentially over.

### A false alarm?

In retrospect, initial estimates were so wrong for several reasons.

Firstly, the public health measures were more effective than expected, enabling most countries to "flatten the curve" or virtually eliminate it.

Secondly, the indications for ventilating people with COVID-19 changed. Initial guidance in March of 2020<sup>45</sup> had called for avoidance of non-invasive ventilation and early intubation. This was largely motivated by the desire to prevent aerosolisation of viral particles leading to infection of staff and others. However over the next few months there was a gradual acceptance of the potential role of high-flow nasal oxygen<sup>38</sup> and nasal CPAP, providing that staff were provided with adequate personal protective equipment (PPE)<sup>39</sup>. By May, many authors were beginning to seriously question the desirability of early intubation<sup>40-42</sup>. While data remained scant, there was a growing realisation that the acute risks of ventilation-induced lung injury, ventilation-acquired pneumonia, and difficult weaning needed more consideration<sup>42</sup>.

All through March and April 2020 many overwhelmed healthcare systems had been forced to defer intubation because of limited capacity. The results of these natural experiments began to appear in the literature by early June. One of the first case series<sup>43</sup> compared four patients that had been intubated early with six following patients who had been initially managed with high flow nasal oxygen and self-proning. While the intubated group required a median of 12 days ventilation, only two of the second group required intubation and the length of stay for this group was shorter overall. Many other case series of patients being treated successfully with non-invasive ventilation and self-proning were soon published<sup>44-48</sup>.

Concurrently, there was a realisation that COVID-19 induced ARDS was different to that observed from other pathophysiological insults. COVID-19 ARDS generally followed the L type pattern with preserved compliance, low recruitability<sup>41,49</sup> and the so-called “happy hypoxia”<sup>50</sup>. This realisation was not initially coupled with a willingness to defer intubation; worrying evidence began to emerge that many patients were developing pulmonary fibrosis<sup>51</sup> and that mechanical ventilation might be an independent risk factor as a result of ventilator-induced lung injury. Emerging medical treatments<sup>52</sup>, notably remdesivir and dexamethasone, also probably helped reduce the number of patients requiring invasive ventilation.

Finally, as the situation evolved, it rapidly became clear that ventilators alone would not be enough without adequate staffing and consumables<sup>53,54</sup>. It also became clear that the initial request for basic ventilators that did not include the ability to synchronise was misguided<sup>29</sup>.

By August 2020, fears of a ventilator short-fall had disappeared. The Australian government had taken delivery of more than 2000 locally manufactured Notus ventilators<sup>55</sup> adding to an already significant stockpile. UK manufacturers had rapidly produced 14,000 ventilators and the NHS had secured around 16,000 CPAP and non-invasive ventilators<sup>56</sup>. In the USA, Ford and General Motors delivered 80,000 ventilators to the national stockpile, and began winding down their ventilator manufacturing<sup>57</sup>.

### Did we learn anything in the rush?

Despite the relative brevity of the “Great ventilator rush of 2020”, the episode triggered an unprecedented public focus on ventilators, what they do, and how to make them. The resulting bloom of ventilator projects was always admirable and well intentioned, generally creative but more than occasionally frightening.

This paper reports our observations of projects that set out to operate using an open-source framework. Those seeking a more conventional discussion of ventilators and ventilation should refer to some of the recent texts on the topic<sup>58,59</sup>. As the dust settles and with the half-completed relics of a sudden burst of activity left scattered around internet repositories, we wonder if the world can extract anything useful.

The ventilator shortage occurred in a context where hospitals were likely to be overwhelmed. At the time it seemed possible hospitals could become overrun with patients while simultaneously suffering a significant loss of staff just as pallet loads of rapidly assembled ventilator hardware arrived on hospital loading docks.

So, in those early months of 2020 it appeared that we potentially needed millions<sup>3</sup> of non-existent ventilators with the following unique requirements:

- Rapidly manufacturable without dependence on traditional supply chains.
- Avoid venting viral aerosols into the environment.
- Easy to use by overworked, inexperienced and fatigued staff.
- Capable of efficiently weaning patients.

Particularly the last two raise ongoing challenges.

## OPEN-SOURCE HARDWARE

Well before the pandemic began, a collection of advances was disrupting traditional approaches to organising intellectual projects and even hardware manufacturing.

Open-source software-engineering practices have their roots in the 1950s and gained momentum with the birth of high-speed computer connectivity. The world wide web of hypertext servers which now underpins the internet, as most of us experience it, was built on software that had been written incrementally by coders who were either unpaid or worked for organisations that gave away any intellectual property rights for their work. The so-called “LAMP stack”, a set of open-source software used for web application development, was written entirely in this manner and demonstrated the formidable capacity of open intellectual capability unshackled by copyright and patents. Founded in January 2001, Wikipedia<sup>60</sup> had extended the open approach to the organisation of human knowledge itself, rapidly surpassing the efforts of commercial competitors in many domains.

Underpinning these efforts are free and sophisticated version control systems, notably “git” software<sup>61</sup> written by Linus Torvalds, creator of the free computer operating system, GNU/Linux. The version control systems enable multiple contributors to “fork” and “clone” files within “repositories”, propose edits via “patches” which project leaders can review via “pull requests”. Git is freely available via several easy to use web platforms. In modern software projects many repositories integrate continuously deployed automated tests which ensure that proposed changes do not break existing functionality. Arguably, high-quality test frameworks are more valuable than the code itself. While this level of automated testing is not possible in hardware projects, such sophisticated test methodologies show that an open-source approach does not equate with chaos and poor quality.

Around the same time that Wikipedia entered household vernacular, there was growing attention to applying these open-source approaches to hardware. Computer controlled manufacturing such as 3D printers, CNC mills, and laser cutters have unlocked the ability to share designs across the world and then rapidly manufacture them locally. Affordable and easy to use open-source microcontrollers, notably the “Arduino”, were soon developed<sup>62</sup> making sophisticated electronic control systems widely available. Even though 3D printing is comparatively slow compared to manufacturing at scale, it allowed rapid increases in localised production capacity<sup>33</sup>. One university laboratory produced a large number of 3D printed face shields<sup>63</sup>.

Publication of design files is not enough for a design to be truly open-source<sup>33</sup>. “Open-source” or “free-libre open-source” designs and code require a license enabling others to legally use published designs without paying fees or infringing copyrights. Truly usable practical open-source hardware designs additionally require publication of accessible design source files, bills of materials, assembly instructions, wiring diagrams, all software, as well as operation, production, calibration instructions, and documentation to facilitate regulatory approval<sup>33</sup>.

Publication of open-source designs allows potential review and feedback from a larger pool of expert reviewers than when the design remains locked up in corporate or private repositories. If open-source teams use publicly accessible repositories as they go along, publishing continuously, their work is discoverable and can inform any related work, even if still a work in progress.

Open-source publication enables other teams to continue to refine designs after the initial project has concluded. This enables multiple people separated both spatially and temporally to incrementally refine and build complete designs. Furthermore, it is possible for teams to modify existing complete designs to account for local conditions and constraints.

The urgency and over-shadowing supply-chain disruption in the early months of the pandemic made the open-source approach even more attractive for the manufacture and supply of ventilators<sup>34,13,33</sup>, diagnostics and personal protective equipment<sup>13</sup>.

### The open-source ventilator rush

None of the authors joined a specific project team but instead aimed to assist the community working on open-source ventilators where we could. Public Invention facilitated what we believe to be the most comprehensive collation of open-source ventilator projects<sup>36</sup>. This effort brought us into close contact with many teams and makes us somewhat uniquely placed to reflect on the open-source ventilator supply efforts of early 2020.

Overall, despite all the invested energy, the results have generally fallen well short of the expectations of those that started in the endeavours. While many things were done well<sup>64</sup> we observed obvious short-comings in the activities. Others made similar observations<sup>33,34,65</sup>.

Santos et al systematically reviewed 32 open-source ventilators in late 2020 in terms of availability of online information, licensing and certification development status<sup>65</sup>. They found that while all but one of the projects they identified posted their production files on the internet, neither of the two projects that had published in the peer-reviewed literature had also published their full production files. Only 14 of the 32 projects had published testing guidelines, and only 11 had published operation manuals. Most of the projects had some kind of appropriate licencing. Twenty-six teams had made prototypes and eight had performed some kind of human testing. Five projects had been granted some kind of regulatory approval. We are not aware of any actual clinical use of the open-source ventilator projects of 2020, however at least one open design was modified and entered commercial production<sup>34</sup>.

As of 20 March 2021, 84 ventilators of various types have received FDA Emergency Use Authorisation (EUA). However only a handful of open-source ventilators achieved EUA and these were all the bag-squeezer type ventilators without capacity to support synchronized breathing. It is unclear if any of these were ever deployed and used clinically.

### Globally rapid initiation

One of the most impressive aspects of the open-source response was the speed of the initial response. We observed inventors, makers and humanitarian engineers, many idled by lockdowns, globally applying their creativity to this problem almost immediately<sup>39</sup> with consortia and organisations appearing virtually overnight<sup>66-68</sup>.

The efforts were often international from inception and were founded in Europe, North America, South America, Asia, and Africa. Many caught public attention<sup>69</sup>. International co-operation seemed to be taken for granted.

### Government facilitation and regulation

Most participants in open-source projects have no experience with practices needed for regulatory approval. Regulatory experts provided some advice but were in short supply. We repeatedly observed engineers concerned about liability and intimidated by fear, uncertainty, and doubt (FUD) around the law of liability and open-source licensing.

Volunteer open-source efforts predictably struggled to navigate even the reduced regulatory requirements. However, it is clear that the regulators were not an unreasonable barrier as multiple non-open-source products were given approval. Between 25 March and 23 July, the FDA would provide EUAs for 71 different ventilators<sup>70</sup>. By 31 January 2021, the Australian TGA had permitted three ventilators under an emergency exemption<sup>71</sup>. Notably only one of the three TGA permitted ventilators apparently supported synchronised ventilation, but the TGA noted that the manufacturer had not provided validation data. The exemption ceased on 31 January 2021 with the TGA strongly recommending caution in their use as they have not had their safety or performance fully tested<sup>71</sup>.

While it seems that volunteer efforts are unlikely to ever by themselves cross this hurdle it is certainly possible that with enough time teams could lay the foundations for regulatory approval.

### Internet as an enabler

COVID-19 exposed the relatively glacial pace of the academic peer-reviewed approach to literature. While the traditional journals continued to play a vital role, the speed of the crisis led many to rely on internet-based communication<sup>13</sup>.

As the pandemic erupted, large non-profit and commercial organisations rapidly adopted modern remote collaboration tools such as sophisticated chat clients (like Slack and Discord) and video conferencing (like Zoom, Google Meet, and Skype). Shared git repositories and open documents that could be commented on by the general public were extremely effective, with minimal vandalism. Gaps in medical knowledge of the engineering community were addressed by rapidly organised virtual conferences<sup>72</sup>, a widely-read briefing document<sup>73</sup> and peer-reviewed publications<sup>74</sup>.

### Misalignment between effort and publication

Many teams declared themselves open-source, but in fact delayed sharing reproducible details of their work or closed-sourced their work in response to investors or FUD. This persistent issue was observed early on<sup>33</sup>. This may have been due in part to inadequate resources as many teams did not successfully recruit sufficient technical writers, outreach coordinators, project managers, graphic artists, social media experts.

Conversely some engineering teams, perhaps supported by overly enthusiastic public relations teams, published videos and demonstrations early on but then never followed through with technical publications in any form<sup>33</sup>.

### Medical knowledge limitations

Effort and time was required to bridge the gap between the vocabulary and practice of the engineering and medical communities. Medical and engineering jargon differ significantly. Individuals fluent in both were extremely valuable. Even measuring pressure in cmH<sub>2</sub>O was quaint and arcane to many engineers. Non-standard naming conventions further added to the confusion<sup>75</sup>.

Most engineering teams reported making noble, if somewhat unsuccessful, efforts to enlist true medical professionals to provide advice. However, many doctors were too busy treating patients to participate, and many engineers were reluctant to do the necessary learning outside their expertise. Many doctors communicated individually to engineering teams. However, this effort was based on personal relationships and often not shared outside those teams. There was no worldwide doctor-to-engineering interface. As a result, many engineers started from a standing start.

There were initially few open-source designs to build upon<sup>76,77</sup> and none that laid the foundation for a ventilator that could compete with the features of modern ICU ventilators. Many engineers succumbed to the temptation to build before fully understanding the clinical nature of the problem.

### Changing understanding of both disease and requirements

While very helpful, the early government specifications were vague and conflicting. Neither the 18 March UK RMVS<sup>29</sup>, nor the 7 April Australian TGA guide<sup>30</sup> emphasised the requirement for supporting spontaneous breathing. It was not until 10 April that the UK revised the RMVS to stress the desirability of supporting spontaneous ventilation. By then many teams had locked in a design architecture and most would never change direction.

The reluctance to change designs was compounded by an initial failure to appreciate that providing ventilator support to patients requires much more than just a physical ventilator<sup>54</sup>. Thus, there was a general trend for many open-source teams to aim for hardware that was extremely cheap to manufacture. As a result, many designs were underpowered<sup>78</sup> and unlikely to ever support synchronised respiration. Ventilators without a synchronised mode require keeping patients deeply paralysed and sedated leading to prolonged weaning. The resulting prolonged ventilation would have led to even greater strain on staffing and drains of therapeutic oxygen and other scarce consumables.

### Supply chain issues

Outside of the engineering teams' control, the worldwide supply chain was shown to be opaque and fragile. For example, a single firm, Sensirion, created flow sensors that were widely relied upon. Although they made an extraordinary effort to increase production, there was a noticeable worldwide limitation of flow sensors. During the rush our teams personally experienced delays of several months securing small research quantities of these components.

There is no entity that can collate demand effectively when the crisis is too acute and chaotic for normal marketing and purchasing procedures. Buyers, who are never monolithic, were hesitant to discuss demands for untested and unfamiliar products in a time of crisis. The potentially short-lived and chaotic nature of demand spikes and supply shortages made businesses reluctant to commit to increasing supply of rapidly developed new products. Previously initiated supply chain resilience efforts<sup>79</sup> were redoubled.

### Commercial efforts

Neither journalists nor those working in the open-source space were granted insights into the production schedules of corporations. Commendably, on 30 March, Medtronic published the design for the Puritan Bennett 560 ventilator<sup>80</sup> but stipulated that any ventilator hardware based on the design<sup>81</sup> be labelled "for use only in the pandemic".

### Safety and compliance

Safety and compliance are at the core of all medical devices throughout their lifetime. Modern ventilators are complex devices with mechanical, electrical and software components that have to meet a comprehensive set of safety standards (see Box 1). This daunting and opaque process was made more transparent for engineering teams through continuous education by peers, experts, industry publications, and a virtual conference was held on Quality Assurance and Regulatory Compliance<sup>72</sup>. ISO and IEC also generously released a number of relevant standards to support global COVID-19 efforts<sup>82,83</sup>.

### Box 1. Ventilator standards for ventilators<sup>84</sup>

- 1-62 ISO 5356-1 Third edition 2004-05-15  
Anaesthetic and respiratory equipment - Conical connectors: Part 1: Cones and sockets
- 1-98 ISO 80601-2-12 First edition 2011-04-15  
Medical electrical equipment - Part 2-12: Particular requirements for the safety of lung ventilators - Critical care ventilators [Including: Technical Corrigendum 1 (2011)]
- 1-129 ISO 5359 Fourth edition 2014-10-01  
Anaesthetic and respiratory equipment - Low-pressure hose assemblies for use with medical gases [Including AMENDMENT 1 (2017)]
- 1-130 ISO 18082 First edition 2014-06-15  
Anaesthetic and respiratory equipment - Dimensions of noninterchangeable screw-threaded (NIST) low-pressure connectors for medical gases [Including AMENDMENT 1 (2017)]
- 1-134 ISO 18562-1 First edition 2017-03  
Biocompatibility evaluation of breathing gas pathways in healthcare applications - Part 1: Evaluation and testing within a risk management process
- 1-135 ISO 18562-2 First edition 2017-03  
Biocompatibility evaluation of breathing gas pathways in healthcare applications - Part 2: Tests for emissions of particulate matter
- 1-136 ISO 18562-3 First edition 2017-03  
Biocompatibility evaluation of breathing gas pathways in healthcare applications - Part 3: Tests for emissions of volatile organic compounds
- 1-137 ISO 18562-4 First edition 2017-03  
Biocompatibility evaluation of breathing gas pathways in healthcare applications - Part 4: Tests for leachables in condensate
- 1-138 ISO 80601-2-74 First edition 2017-05  
Medical electrical equipment - Part 2-74: Particular requirements for basic safety and essential performance of respiratory humidifying equipment
- 1-146 ISO 80601-2-12 Second edition 2020-02  
Medical electrical equipment - Part 2-12: Particular requirements for basic safety and essential performance of critical care ventilators

Any material used in the airway needs to be tested for biocompatibility to ISO 18562<sup>85</sup>, leading many teams to design automated squeezers for existing self-inflating bags. Polyvinyl chloride (PVC) plastic plumbing parts were also a popular choice with pandemic ventilator teams. However, the TGA Ventilator specification for COVID-19<sup>90</sup> forbids the use of PVC. Phthalates (plasticisers) and common building materials are a known risk for respiratory and allergic effects<sup>86</sup>. Ultimately the product gas needs to be tested to demonstrate it contains no harmful by-products.

Although much knowledge was shared and many promising prototypes were developed, the cost and complexity to take a medical device through the regulatory approval process to market still presents a significant barrier. The creation of free open-source software (FOSS) and hardware (FOSH) safety and compliance tools and continued education could help accelerate future development of open-source medical devices.

## MANUFACTURING

With lockdowns hindering traditional manufacturing processes, many teams turned to low-cost 3D printers to manufacture parts for prototyping and in some cases for end-use. A popular workflow was to design parts in free CAD software and share the designs online, which could then be downloaded and printed anywhere in the world. This allowed for rapid design iterations and high levels of collaborative problem solving.

3D printing technology is being widely adopted in the medical field for a multitude of uses<sup>87</sup>. The most common type of 3D printer is Fused Filament Fabrication (FFF) where a thin plastic wire is extruded repeatedly in layers to build a 3D part. Polylactic acid (PLA) is the most popular plastic used in FFF printers because of its low melting point, however this also makes it difficult to sterilise. High end FFF printers can print polycarbonate and polyether ether ketone (PEEK), which may be steam sterilised, but challenges remain in the 3D printing process

such as ensuring air-tightness between the printed layers and maintaining a clean-room level manufacturing environment. Despite these challenges, 3D printing was successfully used in low-risk use products such as face-shields<sup>88</sup>.

## THE RELICS OF THE RUSH

One of the biggest take-aways from early 2020 was the importance of making ventilators that were optimised for use in sub-optimal contexts<sup>54</sup>.

As the pandemic passes we can imagine future situations where easier to use ventilators could still save lives, in a similar way that automated defibrillators appear to have<sup>89</sup>. Currently powerful microcontroller boards and small touch screens are available for a few dollars. Yet many pandemic ventilators were designed with technological approaches that date to 1940s, or 1970s at best. Even though fully featured modern ventilators provide excellent graphics and descriptions of sensor readings out of range, they do not use these enhanced capabilities to specifically guide on how to clinically respond to measured ventilation parameters.

There are numerous opportunities to aid inexperienced, overworked or fatigued doctors and nurses with clearer guidance and automated control. Conditions such as bronchospasm, pneumothorax, patient-ventilator asynchrony (PVA), disconnection and tube kinking all have readily identifiable impacts on sensor readings. In some cases, adding decision support would be quite simple. Thus, it is probable that ventilators do not report a differential diagnosis, yet alone treatment suggestions, simply because designs assume that the ventilators would only ever be used in the presence of highly trained doctors and nurses. Other decision support algorithms will be more challenging. For example, managing PVA is complex<sup>90,91</sup> and unreliably managed even in well-resourced ICUs<sup>89,92</sup>.

Recognising this need, and the opportunity to channel the expertise developed by many during the rush, we initiated VentOS, a project with the mission:

“To create a free and open-source software library and embedded operating system to enable engineering teams to develop safe and effective invasive and non-invasive ventilators for diverse contexts.”<sup>93</sup>

This project, still in early phases of development, continues to work closely with the open-source ventilator teams that are continuing to develop their devices.

Others have long recognised computer based protocols<sup>94</sup>, or more recently, smarter ventilators, could assist everyday management even in well-resourced services<sup>95-100</sup>. Importantly during the resource constraints of a pandemic, ventilator-based decision support offers the prospect of efficient weaning<sup>101</sup>. Even when protocols are clearly defined, new alternatives continue to evolve<sup>102-105</sup>, but experience has shown poor adherence with paper-based protocols<sup>95,100</sup>. Integrating some algorithms into computer code would facilitate rigorous evaluation and subsequent deployment of such new ventilatory approaches. The support could come initially in an “open loop” form where a clinician needs to actuate each suggestion, before possibly moving on to “close loop” systems<sup>95</sup>. Already a promising field of ICU research across many fronts<sup>104</sup>, increasing focus on artificial intelligence and machine learning is likely to increase the pace of change.

While trials using computer based protocols are ongoing<sup>106</sup>, patents have limited application of some approaches<sup>98</sup> and it is possible that an open-source approach to algorithms may enable more rapid deployment and development of advanced algorithms. There currently exists no open platform on which existing protocols, or those that are emerging, can be efficiently deployed across existing ventilator hardware. It is an open question whether best-practice open-source software, possibly based on the ongoing VentOS project, could change this.

## NOTABLE HARDWARE APPROACHES AND DESIGNS

Whatever else may have been missing in the great ventilator rush, creativity was abundant. A number of heterodox solutions were explored.

By far the most common approach adopted was to make a mechanical bag squeezer. This was unfortunate. Pre-pandemic open-source designs already existed<sup>76,77</sup> and numerous teams followed this lead. For the non-medical personnel, the appeal of taking the relatively cheap, safe and ubiquitous self-inflating bag and mechanically squeezing it was hard to resist. Given that these devices typically came with FDA approval, many believed that simply enclosing one in a squeezing mechanism would be practical and avoid bio-compatibility issues in the airway.

There are two core problems with using self-inflating bags. Firstly, the bag itself has complex compliance mechanics that will vary between manufacturers and over time. Reliable detection of mechanical ventilation will be difficult as the bag re-inflates, effectively mimicking patient respiratory effort. There appear to be no reports of attempts to evaluate a bag-squeezer in a synchronised mode.

The other fundamental flaw with mechanical bag squeezers is that these devices are not designed to cope with the mechanical stress of prolonged use, particularly continuous flexing in exactly the same location, which may eventually result in fatigue failure. Splitting of the bag at some random time, possibly 3am, is a significant risk.

The ARMEE device<sup>107</sup>, a reconstitution of a design from the 1960s<sup>108</sup> is one of the more intriguing proposals. It was developed by the US Army for emergencies, and attracted early attention because of the ability to 3D print or mill these devices, literally in the millions. It has no moving parts or electronics, simply a pair of adjustment screws. It works purely on fluidic control of a flow of gas, weighs under 250g and is less than 20 by 50 by 90mm in size. Initial research by the US Army found that, in order to deliver a 6L/min minute volume, the device requires a driving gas at 150cmH<sub>2</sub>O and 28L/min. Because medical gases continue to flow during exhalation, it wastes therapeutic oxygen (see Figure 1).

**Figure 1. Flow analysis of the ARMEE vent device, illustrating the fluidic control of flow during inspiration (left) and expiration (right)**

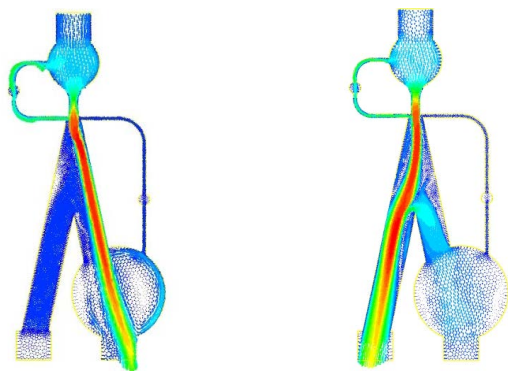

We have seen no reports of its practical use in a clinical setting but suspect that the interaction between patient physiology, efforts and alterations in driving pressure could prevent precise control of parameters such as rate, positive end-expiratory pressure (PEEP), inspiratory to expiratory (I:E) ratio and peak inspiratory pressure (PIP).

Smith Vent<sup>109</sup>, by engineering alumni and friends of Smith College in Massachusetts was one of the outstanding projects, winning a major competition<sup>110</sup>. The Smith Vent, like the People's Ventilator Project<sup>111</sup>, uses standard high-pressure medical oxygen and air supplies that it blends using two solenoid valves and a reservoir before fine controlling inspiratory flow with a proportional solenoid valve. Expiration is controlled with another solenoid valve and adjustable PEEP valve. The device incorporates a touch screen, three separate pressure sensors and dual flow sensors all orchestrated by a microcontroller (see Figure 2 and Figure 3).

**Figure 2. Schematic of the Smith Vent**

Source: <https://github.com/SmithVent2020/circuit-control/blob/master/images/system-diagram.png>

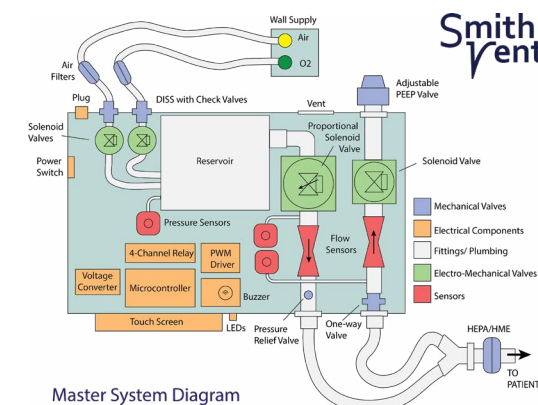

**Figure 3: Rendering of Smith Vent design**

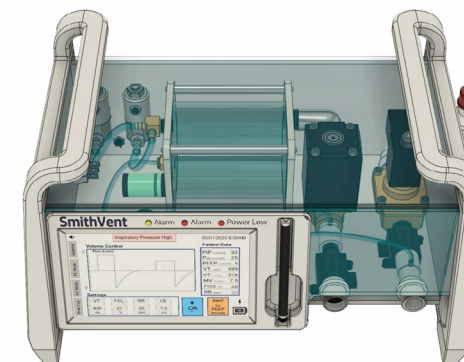

Finally, recognising the need for a low cost testing device, a ventilation test and monitoring device, the VentMon<sup>112</sup>, was developed in March 2020 with volunteers by two of the authors (BC,RR). The VentMon is a FOSH device using standard 22mm connectors to enable ventilator developers to record flow, pressure and oxygen concentration waveforms in order to test and evaluate a ventilator. The design exemplifies a modular approach where potential a single specialised component may then support other hardware designs. The VentMon was funded by two flash grants and given away to open-source ventilator teams.

## CONCLUSION

"The great ventilator rush of 2020" drew global attention to the urgent need to rapidly make millions of obscure and complicated medical devices. Ultimately, the open-source ventilator efforts were gallant but failed to deliver operational hardware beyond a few test items. It is our view that the natural desire to be a hero, the difficulty in communication, lack of organisation and the pandemic "fog of war" led multiple isolated teams to rush towards "the" solution without producing useful components. The "not-invented-here syndrome" further compounded duplication of effort.

Comparing the open-source PPE efforts with the ventilator efforts is illuminating. Humanitarian crafters and makers effectively produced PPE in large quantities. One non-profit organisation alone provided over 39 million face shields, gowns, and cloth masks<sup>113</sup>. These items are far simpler to design and manufacture than ventilators and were able to more readily bypass strict testing requirements that ventilators cannot escape.

Certainly, the open-source community demonstrated a willingness to follow leadership which is perceived as unbiased, competent, and ungreedy — but this does not automatically make such leadership appear. In order to be effective, the effort requires individuals able to understand both medical and engineering needs who are willing and able to provide sufficient time to lead teams.

Based on this learning and experience, we suggest that in the future, open-source teams:

- Identify and solve reusable, modular, composable pieces of the total problem.
- Be open from day one. Publish early and often so that other teams can discover what you are doing.
- Seek out other aligned teams and organizations and allocate resources to communicate with and act as ambassadors to them.
- Expect that requirements, needs, and understandings will change and be prepared to stop and reverse direction.
- Be humble. Small, well-documented and published contributions add up and increase the chance of saving lives more than complete solutions which are never deployed or published.

## ACKNOWLEDGEMENTS

We wish to acknowledge the hundreds of engineers and makers who generously gave their time to help others as the COVID-19 pandemic erupted.

## REFERENCES

1. Tong S. Countries race to limit or ban mask and ventilator exports - Marketplace [Internet]. Marketplace. 2020 [cited 2021 Feb 21]. Available from: <https://www.marketplace.org/2020/03/30/countries-race-to-limit-ban-exports-of-masks-ventilators-other-gear/>
2. Meares HD, Jones MP. When a system breaks: queueing theory model of intensive care bed needs during the COVID-19 pandemic. *Med J Aust* [Internet]. 2020 Jun;212(10):470–1. Available from: <http://dx.doi.org/10.5694/mja.250605>
3. Ranney ML, Griffith V, Jha AK. Critical Supply Shortages - The Need for Ventilators and Personal Protective Equipment during the Covid-19 Pandemic. *N Engl J Med* [Internet]. 2020 Apr 30;382(18):e41. Available from: <http://dx.doi.org/10.1056/NEJMp2006141>
4. ANZICS COVID-19 Working Group. The Australian and New Zealand Intensive Care Society COVID-19 Guidelines (Version 1, 16 March 2020) [Internet]. 2020 [cited 2021 Feb 28]. Available from: <http://www.anzics.com.au/wp-content/uploads/2020/03/ANZICS-COVID-19-Guidelines-Version-1.pdf>
5. Faculty of Intensive Care Medicine, Intensive Care Society, Association of Anaesthetists and Royal College of Anaesthetists. Critical care preparation and management in the COVID-19 pandemic - 17 March 2020 [Internet]. ICM Anaesthesia COVID-19. 2020 [cited 2021 Feb 28]. Available from: <https://icmanaesthesiacovid-19.org/critical-care-preparation-and-management-in-the-covid-19-pandemic>
6. Namendys-Silva SA. Respiratory support for patients with COVID-19 infection. *Lancet Respir Med* [Internet]. 2020 Apr;8(4):e18. Available from: [http://dx.doi.org/10.1016/S2213-2600\(20\)30110-7](http://dx.doi.org/10.1016/S2213-2600(20)30110-7)
7. Impact of COVID-19 : theoretical modelling of how the health system can respond / Department of Heal. [Internet]. [cited 2021 Feb 20]. Available from: <https://catalogue.nla.gov.au/Record/8173969>
8. Rubinson L, Vaughn F, Nelson S, Giordano S, Kallstrom T, Buckley T, et al. Mechanical ventilators in US acute care hospitals. *Disaster Med Public Health Prep* [Internet]. 2010 Oct;4(3):199–206. Available from: <http://dx.doi.org/10.1001/dmp.2010.18>
9. Peterson A, Largent EA, Karlawish J. Ethics of reallocating ventilators in the covid-19 pandemic. *BMJ* [Internet]. 2020 May 12;369:m1828. Available from: <http://dx.doi.org/10.1136/bmj.m1828>
10. Phillips JP, Ragazzoni L, Burel WG, Burkle FM, Keim M. Report from the COVID-19 Virtual Summit, , March 31, 2020. *Prehosp Disaster Med* [Internet]. 2020 Aug;35(4):420–5. Available from: <http://dx.doi.org/10.1017/S1049023X20000552>
11. Neighmond P. As The Pandemic Spreads, Will There Be Enough Ventilators? [Internet]. NPR. 2020 [cited 2021 Feb 20]. Available from: <https://www.npr.org/sections/health-shots/2020/03/14/815675678/as-the-pandemic-spreads-will-there-be-enough-ventilators>
12. Coronavirus and the race to make ventilators - BBC Newsnight [Internet]. 2020 [cited 2021 Feb 20]. Available from: <https://www.youtube.com/watch?v=DMMKkLokwq0>
13. Maia Chagas A, Molloy JC, Prieto-Godino LL, Baden T. Leveraging open hardware to alleviate the burden of COVID-19 on global health systems. *PLoS Biol* [Internet]. 2020 Apr;18(4):e3000730. Available from: <http://dx.doi.org/10.1371/journal.pbio.3000730>
14. Whalen J, Romm T, Gregg A, Hamburger T. Scramble for medical equipment descends into chaos as U.S. states and hospitals compete for rare supplies. *The Washington Post* [Internet]. 2020 Mar 24 [cited 2021 Mar 2]; Available from: <https://www.washingtonpost.com/business/2020/03/24/scramble-medical-equipment-descends-into-chaos-us-states-hospitals-compete-rare-supplies/>
15. Saul J, Dowsett S, Baertlein L, Jonathan Saul Sonya Dowsett. Western supply chains buckle as coronavirus lockdowns spread [Internet]. Reuters. 2020 [cited 2021 Feb 20]. Available from: <https://www.reuters.com/article/us-health-coronavirus-freight-idUSKBN21A2PB>
16. Department for Business, Energy & Industrial Strategy. Call for businesses to help make NHS ventilators [Internet]. GOV.UK. 2020 [cited 2021 Feb 20]. Available from: <https://www.gov.uk/government/news/production-and-supply-of-ventilators-and-ventilator-components>

17. Department of Industry, Science, Energy, Resources. Notice for Australian manufacturers of new ventilators [Internet]. [cited 2021 Feb 20]. Available from: <https://www.industry.gov.au/news-media/notice-for-australian-manufacturers-of-new-ventilators>
18. U.S. Department of Health and Human Services. HHS Announces Ventilator Contract with GM under Defense Production Act [Internet]. US Department of Health and Human Services. 2020 [cited 2021 Feb 20]. Available from: <https://www.hhs.gov/about/news/2020/04/08/hhs-announces-ventilator-contract-with-gm-under-defense-production-act.html>
19. Miller J. Germany, Italy rush to buy life-saving ventilators as manufacturers warn of shortages [Internet]. Reuters. 2020 [cited 2021 Feb 20]. Available from: <https://www.reuters.com/article/us-health-coronavirus-draegerwerk-ventil-idUSKBN210362>
20. Beitler JR, Mittel AM, Kallet R, Kacmarek R, Hess D, Branson R, et al. Ventilator Sharing during an Acute Shortage Caused by the COVID-19 Pandemic. *Am J Respir Crit Care Med* [Internet]. 2020 Aug 15;202(4):600–4. Available from: <http://dx.doi.org/10.1164/rccm.202005-1586LE>
21. U.S. Department of Health and Human Services. Optimizing Ventilator Use during the COVID-19 Pandemic [Internet]. US Department of Health and Human Services. 2020 [cited 2021 Feb 20]. Available from: <https://www.hhs.gov/about/news/2020/03/31/optimizing-ventilator-use-during-covid19-pandemic.html>
22. The Society of Critical Care Medicine (SCCM), American Association for Respiratory Care (AARC), American Society of Anesthesiologists (ASA), Anesthesia Patient Safety Foundation (APSF), American Association of Critical-Care Nurses (AACN), and American College of Chest Physicians. Joint Statement on Multiple Patients Per Ventilator [Internet]. 2020 [cited 2021 Mar 2]. Available from: <https://www.asahq.org/about-asa/newsroom/news-releases/2020/03/joint-statement-on-multiple-patients-per-ventilator>
23. Elhadi M, Msherghi A, Alkeelani M, Alsuyhili A, Khaled A, Buzreg A, et al. Concerns for low-resource countries, with under-prepared intensive care units, facing the COVID-19 pandemic. *Infect Dis Health* [Internet]. 2020 Nov;25(4):227–32. Available from: <http://dx.doi.org/10.1016/j.idh.2020.05.008>
24. Guérin C, Lévy P. Easier access to mechanical ventilation worldwide: an urgent need for low income countries, especially in face of the growing COVID-19 crisis. *Eur Respir J* [Internet]. 2020 Jun;55(6). Available from: <http://dx.doi.org/10.1183/13993003.01271-2020>
25. McLennan A. Vets register ventilators ahead of possible use on coronavirus patients [Internet]. ABC News. 2020 [cited 2021 May 25]. Available from: <https://www.abc.net.au/news/2020-03-25/vet-ventilators-may-be-used-to-treat-coronavirus-patients/12086662>
26. Orser BA, Byrick R, Cooper R, Henry E, Lau P, Rittenberg B, et al. Locating and repurposing anesthetic machines as intensive care unit ventilators during the COVID-19 pandemic. *Can J Anaesth* [Internet]. 2020 Aug;67(8):1066–7. Available from: <http://dx.doi.org/10.1007/s12630-020-01657-w>
27. Arya A, Buchman S, Gagnon B, Downar J. Pandemic palliative care: beyond ventilators and saving lives. *CMAJ* [Internet]. 2020 Apr 14;192(15):E400–4. Available from: <http://dx.doi.org/10.1503/cmaj.200465>
28. Hinton DM. Food and Drug Administration EUA Letter of Authorization [Internet]. 2020 [cited 2021 Mar 15]. Available from: <https://www.fda.gov/media/136423/download>
29. Medicines & Healthcare products Regulatory Agency. Specification for Rapidly Manufactured Ventilator System (RMVS) [Internet]. 2020 Mar [cited 2021 Mar 4]. Available from: <https://www.gov.uk/government/publications/specification-for-ventilators-to-be-used-in-uk-hospitals-during-the-coronavirus-covid-19-outbreak/rapidly-manufactured-ventilator-system-rmvs>
30. Australian Government Department of Health. Therapeutic Goods Administration. Ventilator for COVID-19 use in Australia [Internet]. [cited 2021 Mar 4]. Available from: <https://www.tga.gov.au/ventilator-covid-19-use-australia>
31. Health. Therapeutic Goods (Medical Devices—Ventilators) (COVID-19 Emergency) Exemption 2020. 2020 Apr 8 [cited 2021 Mar 16]; Available from: <https://www.legislation.gov.au/Details/F2020N00046>
32. “A worldwide hackathon”: Hospitals turn to crowdsourcing and 3D printing amid equipment shortages [Internet]. 2020 [cited 2021 Mar 17]. Available from: <https://www.nbcnews.com/tech/innovation/worldwide-hackathon-hospitals-turn-crowdsourcing-3d-printing-amid-equipment-shortages-n1165026>
33. Pearce JM. A review of open source ventilators for COVID-19 and future pandemics. *F1000Res* [Internet]. 2020 Mar 30;9:218. Available from: <http://dx.doi.org/10.12688/f1000research.22942.2>
34. Mora S, Duarte F, Ratti C. Can Open Source Hardware Mechanical Ventilator (OSH-MVs) initiatives help cope with the COVID-19 health crisis? Taxonomy and state of the art. *HardwareX* [Internet]. 2020 Oct;8:e00150. Available from: <http://dx.doi.org/10.1016/j.ohx.2020.e00150>
35. Home - Finalists - CoVent-19 [Internet]. [cited 2021 Mar 17]. Available from: <https://www.coventchallenge.com/>
36. Read RL. Analysis of Open Source COVID-19 Pandemic Ventilator Projects [Internet]. Medium. 2020 [cited 2021 Feb 20]. Available from: <https://robertleeread.medium.com/analysis-of-open-source-covid-19-pandemic-ventilator-projects-27acf9075f7e>
37. Wells CR, Fitzpatrick MC, Sah P, Shoukat A, Pandey A, El-Sayed AM, et al. Projecting the demand for ventilators at the peak of the COVID-19 outbreak in the USA. *Lancet Infect Dis* [Internet]. 2020 Oct;20(10):1123–5. Available from: [http://dx.doi.org/10.1016/S1473-3099\(20\)30315-7](http://dx.doi.org/10.1016/S1473-3099(20)30315-7)
38. Lyons C, Callaghan M. The use of high-flow nasal oxygen in COVID-19. *Anaesthesia* [Internet]. 2020 Jul;75(7):843–7. Available from: <http://dx.doi.org/10.1111/anae.15073>
39. Guan L, Zhou L, Le Grange JM, Zheng Z, Chen R. Non-invasive ventilation in the treatment of early hypoxemic respiratory failure caused by COVID-19: considering nasal CPAP as the first choice. *Crit Care* [Internet]. 2020 Jun 11;24(1):333. Available from: <http://dx.doi.org/10.1186/s13054-020-03054-7>
40. Wilcox SR. Management of respiratory failure due to covid-19. *BMJ* [Internet]. 2020 May 4;369:m1786. Available from: <http://dx.doi.org/10.1136/bmj.m1786>
41. Li X, Ma X. Acute respiratory failure in COVID-19: is it “typical” ARDS? *Crit Care* [Internet]. 2020 May 6;24(1):198. Available from: <http://dx.doi.org/10.1186/s13054-020-02911-9>

42. Rahmzade R, Rahmzadeh R, Tabarsi P, Hashemian SM. Noninvasive Versus Invasive Ventilation in COVID-19: One Size Does Not Fit All! *Anesth Analg* [Internet]. 2020 Aug;131(2):e114–5. Available from: <http://dx.doi.org/10.1213/ANE.0000000000004943>
43. Villarreal-Fernandez E, Patel R, Golamari R, Khalid M, DeWaters A, Haouzi P. A plea for avoiding systematic intubation in severely hypoxic patients with COVID-19-associated respiratory failure. *Crit Care* [Internet]. 2020 Jun 12;24(1):337. Available from: <http://dx.doi.org/10.1186/s13054-020-03063-6>
44. Alviset S, Riller Q, Aboab J, Dilworth K, Billy P-A, Lombardi Y, et al. Continuous Positive Airway Pressure (CPAP) face-mask ventilation is an easy and cheap option to manage a massive influx of patients presenting acute respiratory failure during the SARS-CoV-2 outbreak: A retrospective cohort study. *PLoS One* [Internet]. 2020 Oct 14;15(10):e0240645. Available from: <http://dx.doi.org/10.1371/journal.pone.0240645>
45. Lawton TO, Wilkinson KM, AP Corp, Javid R, MacNally L, McCooe M, et al. Reduced ICU demand with early CPAP and proning in COVID-19 at Bradford: a single centre cohort. *medRxiv* [Internet]. 2020 Sep 7 [cited 2021 Feb 28];2020.06.05.20123307. Available from: <https://www.medrxiv.org/content/10.1101/2020.06.05.20123307v2.abstract>
46. Nightingale R, Nwosu N, Kutubudin F, Fletcher T, Lewis J, Frost F, et al. Is continuous positive airway pressure (CPAP) a new standard of care for type 1 respiratory failure in COVID-19 patients? A retrospective observational study of a dedicated COVID-19 CPAP service. *BMJ Open Respir Res* [Internet]. 2020 Jul;7(1). Available from: <http://dx.doi.org/10.1136/bmjresp-2020-000639>
47. Oranger M, Gonzalez-Bermejo J, Dacosta-Noble P, Llonop C, Guerder A, Trosini-Desert V, et al. Continuous positive airway pressure to avoid intubation in SARS-CoV-2 pneumonia: a two-period retrospective case-control study. *Eur Respir J* [Internet]. 2020 Aug;56(2). Available from: <http://dx.doi.org/10.1183/13993003.01692-2020>
48. Burns GP, Lane ND, Tedd HM, Deutsch E, Douglas F, West SD, et al. Improved survival following ward-based non-invasive pressure support for severe hypoxia in a cohort of frail patients with COVID-19: retrospective analysis from a UK teaching hospital. *BMJ Open Respir Res* [Internet]. 2020 Jul;7(1). Available from: <http://dx.doi.org/10.1136/bmjresp-2020-000621>
49. Gattinoni L, Chiumello D, Caironi P, Busana M, Romitti F, Brazzi L, et al. COVID-19 pneumonia: different respiratory treatments for different phenotypes? *Intensive Care Med* [Internet]. 2020 Jun;46(6):1099–102. Available from: <http://dx.doi.org/10.1007/s00134-020-06033-2>
50. Couzin-Frankel J. The mystery of the pandemic's "happy hypoxia." *Science* [Internet]. 2020 May 1;368(6490):455–6. Available from: <http://dx.doi.org/10.1126/science.368.6490.455>
51. Ojo AS, Balogun SA, Williams OT, Ojo OS. Pulmonary Fibrosis in COVID-19 Survivors: Predictive Factors and Risk Reduction Strategies. *Pulm Med* [Internet]. 2020 Aug 10;2020:6175964. Available from: <http://dx.doi.org/10.1155/2020/6175964>
52. Izda V, Jeffries MA, Sawalha AH. COVID-19: A review of therapeutic strategies and vaccine candidates. *Clin Immunol* [Internet]. 2021 Jan;222:108634. Available from: <http://dx.doi.org/10.1016/j.clim.2020.108634>
53. Phua J, Weng L, Ling L, Egi M, Lim C-M, Divatia JV, et al. Intensive care management of coronavirus disease 2019 (COVID-19): challenges and recommendations. *Lancet Respir Med* [Internet]. 2020 May;8(5):506–17. Available from: [http://dx.doi.org/10.1016/S2213-2600\(20\)30161-2](http://dx.doi.org/10.1016/S2213-2600(20)30161-2)
54. Guan L, Li S, Grange JML, Yang Y, Chen R, Zhou L. Improved mechanical ventilation requires more than just increased ventilator availability: A word of caution. *Clin Transl Med* [Internet]. 2020 Jun;10(2):e43. Available from: <http://dx.doi.org/10.1002/ctm2.43>
55. Department of Industry, Science, Energy, Resources. Australian-made ventilators delivered quickly [Internet]. [cited 2021 Feb 20]. Available from: <https://www.industry.gov.au/news-media/australian-made-ventilators-delivered-quickly>
56. Cabinet Office. Ventilator Challenge hailed a success as UK production finishes [Internet]. GOV.UK. 2020 [cited 2021 Feb 20]. Available from: <https://www.gov.uk/government/news/ventilator-challenge-hailed-a-success-as-uk-production-finishes>
57. White J. GM, Ford coronavirus U.S. ventilator projects close in on their finish lines [Internet]. Reuters. 2020 [cited 2021 Feb 20]. Available from: <https://www.reuters.com/article/us-health-coronavirus-autos-ventilators-idUSKBN25L2P4>
58. Aston D, Rivers A, Dharmadasa A. Equipment in Anaesthesia and Critical Care: A Complete Guide for the Frca [Internet]. Scion Pub Limited; 2013. 404 p. Available from: [https://books.google.com/books/about/Equipment\\_in\\_Anaesthesia\\_and\\_Critical\\_Ca.html?hl=&id=rekklwEACAAJ](https://books.google.com/books/about/Equipment_in_Anaesthesia_and_Critical_Ca.html?hl=&id=rekklwEACAAJ)
59. Pham T, Brochard LJ, Slutsky AS. Mechanical Ventilation: State of the Art. *Mayo Clin Proc* [Internet]. 2017 Sep;92(9):1382–400. Available from: <http://dx.doi.org/10.1016/j.mayocp.2017.05.004>
60. Contributors to Wikimedia projects. Wikipedia [Internet]. Wikimedia Foundation, Inc.; 2001 [cited 2021 Mar 16]. Available from: <https://en.wikipedia.org/wiki/Wikipedia>
61. Git [Internet]. [cited 2021 May 2]. Available from: <https://git-scm.com>
62. Kushner D. The Making of Arduino. *IEEE Spectrum* [Internet]. 2011 Oct 26 [cited 2021 Mar 16]; Available from: <https://spectrum.ieee.org/geek-life/hands-on/the-making-of-arduino>
63. Layt S. 3000 medical shields sourced in a week for Queensland Health [Internet]. Brisbane Times. 2020 [cited 2021 Feb 20]. Available from: <https://www.brisbanetimes.com.au/national/queensland/3000-medical-shields-sourced-in-a-week-for-queensland-health-20200407-p54hwk.html>
64. Gogineni, Sonika, Tanrikulu, Cansu, Konietzko, Erik Paul, Lindow, Kai, Read, Robert. OPEN.Effect: Effectiveness of Open-Source Hardware in Times of a Pandemic. Fraunhofer Institute for Production Systems and Design Technology [Internet]. 2021 Jan [cited 2021 Mar 13]. Available from: <https://www.ipk.fraunhofer.de/en/publications/studies/download-study-open-effect.html>
65. Santos ML, Zacharias LR, Cota VR. Open-source hardware to face COVID-19 pandemic: the need to do more and better. *Research on Biomedical Engineering* [Internet]. 2021 Feb 3 [cited 2021 Mar 14];1–12. Available from: <https://link.springer.com/article/10.1007/s42600-020-00123-2>
66. Helpful Engineering [Internet]. 2020 [cited 2021 Apr 26]. Available from: <https://helpfuleengineering.org/>

67. Open Source Medical Supplies [Internet]. 2020 [cited 2021 Apr 26]. Available from: <https://opencoursemedicalsupsplies.org/>
68. Collective Open Source Medical Innovations for COVID-19 [Internet]. [cited 2021 Apr 26]. Available from: <https://cosmicmedical.ca>
69. The Global Ventilator Race [Internet]. [cited 2021 Feb 20]. Available from: <https://www.bbc.co.uk/programmes/m000j803>
70. Center for Devices, Radiological Health. Ventilators and Ventilator Accessories EUAs [Internet]. 2021 [cited 2021 Mar 16]. Available from: <https://www.fda.gov/medical-devices/coronavirus-disease-2019-covid-19-emergency-use-authorizations-medical-devices/ventilators-and-ventilator-accessories-euas>
71. Australian Government Department of Health. Therapeutic Goods Administration. Ventilators permitted for supply under COVID-19 Emergency Exemption [Internet]. [cited 2021 Mar 16]. Available from: <https://www.tga.gov.au/ventilators-permitted-supply-under-covid-19-emergency-exemption>
72. Read R. Vent-Con2020: Quality Assurance and Regulatory Compliance. [cited 2021 Apr 26]; Available from: <https://www.pubinv.org/ventcon-qa/>
73. Schulz EB. A brief for engineers, by a doctor, on hacking a ventilator for surge capacity in Covid19 patients [Internet]. 2020 [cited 2021 Mar 1]. Available from: <https://docs.google.com/document/d/1sdrKYQ0mDOu4bJum6F6x6piRutJovo7UqFKYHHxUD5A/edit?usp=sharing>
74. Suzumura EA, Zazula AD, Moriya HT, Fais CQA, Alvarado AL, Cavalcanti AB, et al. Challenges for the development of alternative low-cost ventilators during COVID-19 pandemic in Brazil. *Rev Bras Ter Intensiva* [Internet]. 2020 Jul;32(3):444–57. Available from: <http://dx.doi.org/10.5935/0103-507X.20200075>
75. Lei Y. Mechanical Ventilation Modes [Internet]. Oxford University Press; 2017. Available from: <http://oxfordmedicine.com/view/10.1093/med/9780198784975.001.0001/med-9780198784975-chapter-8>
76. Al Hussein AM, Lee HJ, Negrete J, Powelson S, Servi AT, Slocum AH, et al. Design and Prototyping of a Low-Cost Portable Mechanical Ventilator. *J Med Device* [Internet]. 2010 Jun 1;4(2):027514. Available from: <http://dx.doi.org/10.1115/1.3442790>
77. De Santiago C, Dickman N, Nasteff, Nonet T, Raj A, Vasquez K. Attachment to Automate the Bag Valve Mask in Low Resource Settings [Internet]. [cited 2021 Apr 26]. Available from: <http://oedk.rice.edu/Sys/PublicProfile/47585242/1063096>
78. Schulz EB, Read RL. The importance of characterising dynamic response and inertia in potential rapidly manufactured ventilator systems. *Anaesthesia* [Internet]. 2020 Dec;75(12):1690–1. Available from: <http://dx.doi.org/10.1111/anae.15190>
79. Boyens J, Paulsen C, Moorthy R, Bartol N. Supply Chain Risk Management Practices for Federal Information Systems and Organizations [Internet]. National Institute of Standards and Technology; 2015 Apr [cited 2021 Apr 26]. Report No.: NIST Special Publication (SP) 800-161. Available from: <https://csrc.nist.gov/publications/detail/sp/800-161/final>
80. Medtronic Shares Ventilation Design Specifications to Accelerate Efforts to Increase Global Ventilator Production [Internet]. [cited 2021 Mar 14]. Available from: <https://newsroom.medtronic.com/news-releases/news-release-details/medtronic-shares-ventilation-design-specifications-accelerate>
81. Medtronic. Permissive License – Open Ventilator Files [Internet]. [cited 2021 Mar 14]. Available from: <https://www.medtronic.com/content/dam/medtronic-com/global/Corporate/covid19/documents/permissive-license-open-ventilator.pdf>
82. International Organization for Standardization. COVID-19 response: freely available ISO standards [Internet]. 2020 [cited 2021 Apr 26]. Available from: <https://www.iso.org/cms/render/live/en/sites/isoorg/contents/news/2020/04/Ref2502.html>
83. International Electrotechnical Commission. [cited 2021 Apr 26]. Available from: <https://webstore.iec.ch/webstore/webstore.nsf/xpFAQ.xsp?OpenXPage&id=GFOT-BNAEXA>
84. U.S. Food and Drug Administration. Medical Device Database: Product Classification. [cited 2021 Apr 26]; Available from: <https://www.accessdata.fda.gov/scripts/cdrh/cfdocs/cfpd/classification.cfm?id=99>
85. ISO. ISO 18562-1:2017 Biocompatibility evaluation of breathing gas pathways in healthcare applications — Part 1: Evaluation and testing within a risk management process [Internet]. 2017 [cited 2021 Apr 26]. Available from: <https://www.iso.org/cms/render/live/en/sites/isoorg/contents/data/standard/06/28/62892.html>
86. Mendell MJ. Indoor residential chemical emissions as risk factors for respiratory and allergic effects in children: a review. *Indoor Air* [Internet]. 2007 Aug;17(4):259–77. Available from: <http://dx.doi.org/10.1111/j.1600-0668.2007.00478.x>
87. Aimar A, Palermo A, Innocenti B. The Role of 3D Printing in Medical Applications: A State of the Art. *J Healthc Eng* [Internet]. 2019 Mar 21;2019:5340616. Available from: <http://dx.doi.org/10.1155/2019/5340616>
88. Armijo PR, Markin NW, Nguyen S, Ho DH, Horseman TS, Lisco SJ, et al. 3D printing of face shields to meet the immediate need for PPE in an anesthesiology department during the COVID-19 pandemic. *Am J Infect Control* [Internet]. 2021 Mar;49(3):302–8. Available from: <http://dx.doi.org/10.1016/j.ajic.2020.07.037>
89. Holmberg MJ, Vognsen M, Andersen MS, Donnino MW, Andersen LW. Bystander automated external defibrillator use and clinical outcomes after out-of-hospital cardiac arrest: A systematic review and meta-analysis. *Resuscitation* [Internet]. 2017 Nov;120:77–87. Available from: <http://dx.doi.org/10.1016/j.resuscitation.2017.09.003>
90. Subirà C, de Haro C, Magrans R, Fernández R, Blanch L. Minimizing Asynchronies in Mechanical Ventilation: Current and Future Trends. *Respir Care* [Internet]. 2018 Apr;63(4):464–78. Available from: <http://dx.doi.org/10.4187/respcare.05949>
91. de Haro C, Ochagavia A, López-Aguilar J, Fernandez-Gonzalo S, Navarra-Ventura G, Magrans R, et al. Patient-ventilator asynchronies during mechanical ventilation: current knowledge and research priorities. *Intensive Care Med Exp* [Internet]. 2019 Jul 25;7(Suppl 1):43. Available from: <http://dx.doi.org/10.1186/s40635-019-0234-5>
92. Alqahtani JS, AlAhmari MD, Alshamrani KH, Alshehri AM, Althumayri MA, Ghazwani AA, et al. Patient-Ventilator Asynchrony in Critical Care Settings: National Outcomes of Ventilator Waveform Analysis. *Heart Lung* [Internet]. 2020 Sep;49(5):630–6. Available from: <http://dx.doi.org/10.1016/j.hrtlng.2020.04.002>
93. Project VentOS / VentOS [Internet]. [cited 2021 Mar 18]. Available from: <https://gitlab.com/project-ventos/ventos>



94. McKinley BA, Moore FA, Sailors RM, Cocanour CS, Marquez A, Wright RK, et al. Computerized decision support for mechanical ventilation of trauma induced ARDS: results of a randomized clinical trial. *J Trauma* [Internet]. 2001 Mar;50(3):415–24; discussion 425. Available from: <http://dx.doi.org/10.1097/00005373-200103000-00004>
95. Sward KA, Newth CJL. Computerized Decision Support Systems for Mechanical Ventilation in Children. *Pediatr Crit Care Med* [Internet]. 2016 Sep;5(3):95–100. Available from: <http://dx.doi.org/10.1055/s-0035-1568161>
96. Tehrani FT, Roum JH. Intelligent decision support systems for mechanical ventilation. *Artif Intell Med* [Internet]. 2008 Nov;44(3):171–82. Available from: <http://dx.doi.org/10.1016/j.artmed.2008.07.006>
97. Tehrani FT. Automatic control of mechanical ventilation. Part 1: theory and history of the technology. *J Clin Monit Comput* [Internet]. 2008 Dec;22(6):409–15. Available from: <http://dx.doi.org/10.1007/s10877-008-9150-z>
98. Tehrani FT. Automatic control of mechanical ventilation. Part 2: the existing techniques and future trends. *J Clin Monit Comput* [Internet]. 2008 Dec;22(6):417–24. Available from: <http://dx.doi.org/10.1007/s10877-008-9151-y>
99. Kacmarek RM. The mechanical ventilator: past, present, and future. *Respir Care* [Internet]. 2011 Aug;56(8):1170–80. Available from: <http://dx.doi.org/10.4187/respcare.01420>
100. Pelletier JH, Horvat CM. Can Computer Decision Support Help Us Follow Our Own Rules in Pediatric Acute Respiratory Distress Syndrome? *Pediatr Crit Care Med* [Internet]. 2020 Nov;21(11):1000–1. Available from: <http://dx.doi.org/10.1097/PCC.0000000000002567>
101. Burns KEA, Lellouche F, Lessard MR, Friedrich JO. Automated weaning and spontaneous breathing trial systems versus non-automated weaning strategies for discontinuation time in invasively ventilated postoperative adults. *Cochrane Database Syst Rev* [Internet]. 2014 Feb 13;(2):CD008639. Available from: <http://dx.doi.org/10.1002/14651858.CD008639.pub2>
102. Hager DN. Airway Pressure Release Ventilation in Acute Hypoxemic Respiratory Failure: Curb Your Enthusiasm. *Crit Care Med* [Internet]. 2019 Dec;47(12):1817–8. Available from: <http://dx.doi.org/10.1097/CCM.0000000000004054>
103. Goligher EC, Dres M, Patel BK, Sahetya SK, Beitler JR, Telias I, et al. Lung- and Diaphragm-Protective Ventilation. *Am J Respir Crit Care Med* [Internet]. 2020 Oct 1;202(7):950–61. Available from: <http://dx.doi.org/10.1164/rccm.202003-0655CP>
104. Lovejoy CA, Buch V, Maruthappu M. Artificial intelligence in the intensive care unit. *Crit Care* [Internet]. 2019 Jan 10;23(1):7. Available from: <http://dx.doi.org/10.1186/s13054-018-2301-9>
105. Nieman GF, Al-Khalisy H, Kollisch-Singule M, Satalin J, Blair S, Trikha G, et al. A Physiologically Informed Strategy to Effectively Open, Stabilize, and Protect the Acutely Injured Lung. *Front Physiol* [Internet]. 2020 Mar 19;11:227. Available from: <http://dx.doi.org/10.3389/fphys.2020.00227>
106. Khemani RG, Hotz JC, Klein MJ, Kwok J, Park C, Lane C, et al. A Phase II randomized controlled trial for lung and diaphragm protective ventilation (Real-time Effort Driven VENTilator management). *Contemp Clin Trials* [Internet]. 2020 Jan;88:105893. Available from: <http://dx.doi.org/10.1016/j.cct.2019.105893>
107. MillionVentilators. MillionVentilators/ARMEE\_Ventilator\_1.0 [Internet]. [cited 2021 Mar 16]. Available from: [https://github.com/MillionVentilators/ARMEE\\_Ventilator\\_1.0](https://github.com/MillionVentilators/ARMEE_Ventilator_1.0)
108. Joyce JW. TM-68-30 The Army Emergency Respirator [Internet]. US Army Materiel Command; 1968 Oct [cited 2021 Mar 14]. Available from: <https://discover.dtic.mil/wp-content/uploads/pdfs/HDL-TM-68-30.pdf>
109. SmithVent Design - Google Drive [Internet]. [cited 2021 Mar 17]. Available from: <http://tinyurl.com/smithvent>
110. Home - Finalists - CoVent-19 [Internet]. [cited 2021 Mar 17]. Available from: <https://www.coventchallenge.com/>
111. The People's Ventilator Project — PVP 0.2.0 documentation [Internet]. [cited 2021 May 2]. Available from: <https://www.peoplesvent.org/en/latest/>
112. PublInV. PublInV/ventmon-ventilator-inline-test-monitor [Internet]. [cited 2021 Mar 18]. Available from: <https://github.com/PublInV/ventmon-ventilator-inline-test-monitor>
113. Cavalcanti G, Cocciole C, Cole C, Forgues A, Jaqua V, Jones-Davis D, et al. Design, Make, Protect: A report on the open source maker and manufacturer response to the COVID-19 PPE crisis [Internet]. Open Source Medical Supplies and Nation of Makers ; 2021 [cited 2021 Mar 13]. Available from: [https://opensourcemedicalsupplies.org/wp-content/uploads/2021/01/Design-Make-Protect\\_21.01.27.pdf](https://opensourcemedicalsupplies.org/wp-content/uploads/2021/01/Design-Make-Protect_21.01.27.pdf)

## Is one picture worth 1000 words? How discussions of gas uptake in the lung have been compromised for decades by a single diagram

**Ben Korman OAM, BSc, MBBS, MD, PhD, FFARACS, FANZCA**

**Emeritus Consultant, Department of Anaesthesia and Pain Medicine, Royal Perth Hospital  
Adjunct Associate Professor, School of Medicine, University of Western Australia**

Dr Ben Korman has had a longstanding research interest in the uptake and distribution of anaesthetic agents.

This article is based on material in a thesis by the author entitled “Modelling of gas exchange in the lung during nitrous oxide anaesthesia,” submitted in fulfilment of the requirements for the degree of Doctor of Philosophy at The University of Western Australia, 2020.

### INTRODUCTION

While preparing for the Part 1 exam during my first year as an anaesthesia registrar at Royal Perth Hospital in 1974, I came across a diagram used by Edmond Eger to explain certain aspects of gas uptake during nitrous oxide anaesthesia. Eger was one of the pioneers in the field of pharmacokinetics of anaesthetic gases. Indeed, his name is almost synonymous with the subject. Over the years, the diagram had been used repeatedly by Eger and many other authors and still appears in some anaesthetic textbooks today.

I was at first captivated by the diagram but over time, I began to feel there was something wrong. My suspicions were confirmed when a friend pointed out a flaw. If Eger's diagram was wrong, then what was the correct diagram? It took me many years to sort out the puzzle. This is the story of my search for the answers. It involves several prominent figures who have made a lasting impact on our specialty: Seymour Kety, Edmond Eger and William Mapleson.

### KETY'S THEORY OF INERT GAS UPTAKE

In 1951, Kety published what is generally acknowledged to be the first comprehensive review of inert gas exchange in the lungs and tissues<sup>1</sup>. An inert gas merely dissolves in blood and does not interact with it chemically. Our anaesthetic gases are believed to behave in this way, so his findings were very relevant to our specialty. He identified factors which determine the rate of gas uptake and indicated the direction to be followed in subsequent research. Although Kety realised that body tissues could not be treated as a homogeneous tissue mass, the simplest solution was achieved by making this assumption with respect to blood flow and solubility. Importantly, Kety's solution predicts that during washin, the alveolar/inspired concentration of anaesthetic,  $F_A/F_I$ , is independent of the inspired concentration,  $F_I$ .

### ANAESTHETIC UPTAKE IN PERIPHERAL TISSUES

In the period between 1951 and 1963 anaesthetic interest was directed at refining Kety's solution to improve the fit to experimental data. Copperman, cited by Kety, allowed for the division of the body into a number of compartments<sup>1</sup>. The tissue/blood partition coefficient of each tissue compartment could then be adjusted appropriately, instead of assuming a value of 1 as Kety had done. The blood flow per unit of tissue volume was the same in any one compartment but differed from one compartment to another.

The solution of the relevant equations was complicated by the huge number of calculations required and was initially achieved using an electric analogue. Although several analogues were presented at a gathering of experts invited to a famous conference in 1962, the first electric analogue was probably that of Mapleson<sup>2</sup>. His paper was submitted to the prestigious *Journal of Applied Physiology* on 4 December 1961 but was not published until January 1963.

## EGER'S MATHEMATICAL MODEL

At the conference in 1962, Eger produced a mathematical model of uptake and distribution of anaesthetic gases<sup>3,4</sup>. We can summarise the relevant parts of his model as follows<sup>a</sup>:

$$Cg_n = \frac{V_L \cdot Cg_{n-1} + VI \cdot FI - u_n + FI \cdot u_n}{V_L} \quad (1)$$

$$Cb_n = \frac{Cb_{n-1} \cdot \dot{QT} + u_n}{\dot{QT}} \quad (2)$$

$$\lambda = \frac{Cb_n}{Cg_n} \quad (3)$$

where:

$Cg_n$  = concentration of anaesthetic agent in gas phase at the end of the  $n^{\text{th}}$  breath

$Cb_n$  = concentration of anaesthetic agent in blood at the end of the  $n^{\text{th}}$  breath

$V_L$  = volume of air present in the lungs at the end of passive expiration<sup>b</sup>

$VI$  = volume of inspired gas mixture delivered during the  $n^{\text{th}}$  inspiration

$u_n$  = uptake of anaesthetic gas during the  $n^{\text{th}}$  breath

$\dot{Q}$  = pulmonary blood flow

$T$  = duration of each breath

$\lambda$  = blood/gas partition coefficient

The numerator of Equation 1 states that the volume of the anaesthetic gas present in the lung at the end of the  $n^{\text{th}}$  breath ( $Cg_n$ ) is equal to the volume of anaesthetic gas present in the lung at the beginning of the  $n^{\text{th}}$  breath ( $V_L \cdot Cg_{n-1}$ ) plus the volume of the anaesthetic gas brought in during the breath ( $VI \cdot FI$ ) minus the volume of anaesthetic gas absorbed by equilibration with blood ( $u_n$ ) plus the volume of extra fresh gas mixture drawn in to replace the volume of anaesthetic gas transferred to blood ( $FI \cdot u_n$ ).

Equation 3 is the form of Henry's Law commonly used in anaesthesia and respiratory physiology to describe the behaviour of *inert gases*. From his model, Eger predicted that  $F_A / F_I$  would rise more rapidly for higher values of  $FI$ . This is shown in Figure 1 and was subsequently confirmed experimentally<sup>5</sup>. He named this phenomenon the *concentration effect* because it is significant for agents administered at high inspired concentrations, particularly if the agent is very soluble in blood. In Figure 1<sup>c</sup>, the effect is seen to be greater for the more soluble agent, ether, than for nitrous oxide.

a Eger included corrections for temperature, humidification and volume of lung tissue but these are not critical to the discovery of the concentration effect and resulted in his model becoming unnecessarily complicated. We do not include them here as inspired gas is considered to be fully humidified at 37 deg C and we use the fractional concentration in dry gas as our measure of concentration.

b This is the functional residual capacity, FRC.

c For copyright reasons, this diagram and several others in this paper are simulated using inputs from the original publication in a new computer model. Dr Ranjan K Dash, Professor of Bioengineering and Physiology, University of Wisconsin, kindly assisted me in solving the relevant equations in MATLAB.

## Figure 1. The concentration effect

Alveolar concentration as a fraction of inspired concentration for inspired concentrations of 1%, 40%, 75% & 100%  $N_2O$  and 1%, 40% and 75% ether during washin. Simulated using a model with inputs based on Eger's original material<sup>d</sup>.

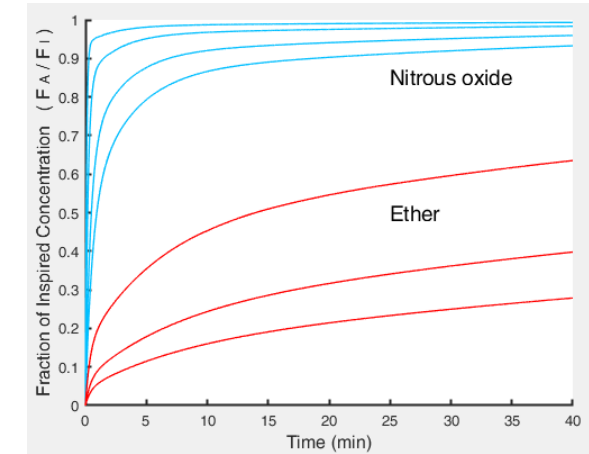

## THE SECOND GAS EFFECT

Because it is a weak anaesthetic agent, it is common to supplement nitrous oxide with low concentrations of a more potent volatile anaesthetic. Using mixtures of nitrous oxide and halothane, Epstein et al<sup>6</sup> showed that when the concentration effect is in operation, it may accelerate the rise of  $F_A / F_I$  for a second agent administered simultaneously (Figure 2). Although the inspired concentration of halothane was the same in both cases,  $F_A / F_I$  rose more rapidly in the presence of 70% nitrous oxide – the *second gas effect*. This effect was interpreted by the authors to be the result of the additional respiratory inflow secondary to the absorption of nitrous oxide at higher concentrations, that is, the term  $FI \cdot u_n$  in Equation 1 above. The effect was subsequently documented for oxygen<sup>7</sup> and carbon dioxide<sup>8</sup>.

## Figure 2. The second gas effect

Simulation of the experiment by Epstein et al<sup>6</sup> using a model with inputs based on the original investigation in which 0.5% halothane was administered to dogs anaesthetised with pentobarbital using one of two possible anaesthetic mixtures. One mixture included 70% nitrous oxide, the other, 10% nitrous oxide<sup>d</sup>.

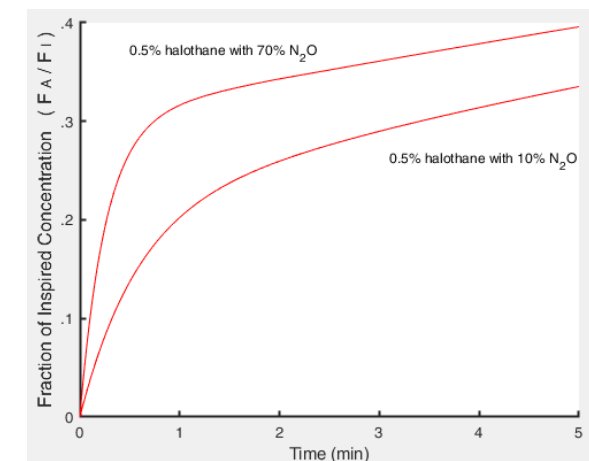

d The original article may be viewed at: <https://anesthesiology.pubs.asahq.org/article.aspx?articleid=1966256>.

## AN ADDITIONAL EXPLANATION FOR THE SECOND GAS EFFECT

In a subsequent investigation, Stoelting and Eger equilibrated dogs with low concentrations of ethylene, cyclopropane or halothane in oxygen<sup>9</sup>. The inspired gas composition was next changed abruptly to a mixture containing 70% nitrous oxide, the equilibrium concentration of the second gas and oxygen.  $F_A$  for the second gas was then observed to rise above  $F_I$  (Figure 3). The authors argued that an increase in the inspired ventilation could not explain these results as it would oppose the rise of  $F_A$  above  $F_I$ . They postulated that an additional factor, a *concentrating effect* must be involved. They illustrated their results by modifying a diagram previously employed by Eger to explain the concentration effect<sup>5</sup>.

### Figure 3. The additional explanation for the second gas effect

Simulation of experiment by Stoelting and Eger<sup>9</sup> using a model with inputs based on the original investigation in which dogs were equilibrated with low concentrations of ethylene (blue,  $\lambda = 0.14$ ), cyclopropane (green,  $\lambda = 0.415$ ) and halothane (red,  $\lambda = 2.3$ ) in oxygen. At the time indicated as zero, the inspired gas composition was abruptly changed to a mixture of 70% nitrous oxide containing the previous concentration of second gas. The balance of the inspired gas mixture consisted of oxygen. The alveolar concentration of each second gas was then observed to rise above the inspired concentration. Ventilation was controlled with a volume-limited ventilator<sup>6</sup>.

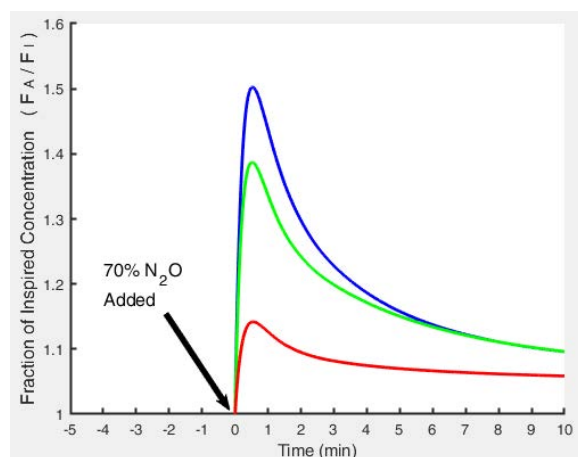

## THE EGER-STOELTING DIAGRAM<sup>e</sup>

### Figure 4. Diagram of hypothetical lung used by Eger and Stoelting to explain the concentration and second gas effects

Reproduced from Stoelting and Eger<sup>9</sup> with permission from copyright owners Wolters Kluwer Health Inc.

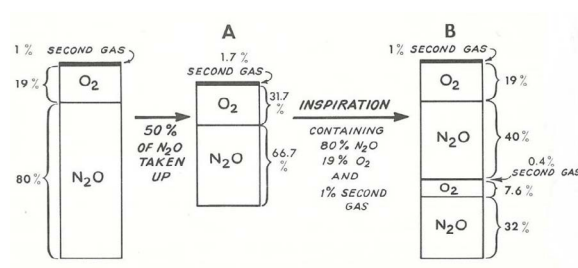

The revised diagram was now used to explain both the concentration and second gas effects. Since its first appearance in *Anesthesiology* in 1969 it has been reproduced in numerous anaesthetic textbooks whenever the effects are discussed. The explanation in the caption given by the authors is as follows:

<sup>e</sup> The original article containing this diagram may be viewed at <https://anesthesiology.pubs.asahq.org/article.aspx?articleid=1965202>

“The hypothetical lung initially contains 80% nitrous oxide, 19% oxygen and 1% second gas.

**A** – the *concentrating effect*. If half the nitrous oxide is taken up, the remaining second gas now represents 1.7% of the total gas volume, while before it represented only 1%. Consequently, the second gas has been concentrated in a smaller gas volume and its alveolar concentration increases.

**B** – the *increased inspiratory ventilation*. This is necessary to maintain lung volume. The inflowing gas contains the same proportions of nitrous oxide, oxygen and second gas as the gas originally present. Although this additional ventilation increases the nitrous oxide concentration from 66.7% to 72%, it dilutes the previously-concentrated second gas and diminishes the magnitude of the second gas effect.”

No doubt Eger believed the diagram to accurately reflect the steps in his mathematical model. Sadly, as we will now demonstrate, this was not the case. Notice that as the rule for equilibrating nitrous oxide with blood, Eger is postulating that half the nitrous oxide is taken up. However, the rule is only applied to the initial gas. The extra gas brought in to replace the nitrous oxide taken up by blood is left unequilibrated in the lung. Looking at Equation 1, we can see that the extra gas is included in the calculation of  $C_{g_n}$  which is itself then equilibrated with blood in Equation 3. Therefore, the diagram and the model are *not* the same.

Moreover, the notion of gas sitting for any length of time in the lung, unequilibrated with blood is incompatible with the basic assumptions of inert gas exchange, a well-known fact by 1969<sup>10,11</sup>. Equilibration with blood leads to the situation shown in Figure 5<sup>12</sup>. The starting situation is shown on the left of the figure. Now however, the extra-inspired ventilation has been added to the original volume  $V$  giving a total volume of  $1\frac{2}{3}V$ . Nitrous oxide comprises 80% of the total volume or  $1\frac{2}{3}V$ . Following proper equilibration with blood according to Eger’s formula that half the nitrous oxide be taken up,  $\frac{2}{3}V$  of the nitrous oxide disappears into blood leaving  $\frac{2}{3}V$  behind in the gas phase.

### Figure 5. Correctly equilibrated version of the Eger-Stoelting diagram

Reproduced in modified form from Korman<sup>12</sup>.

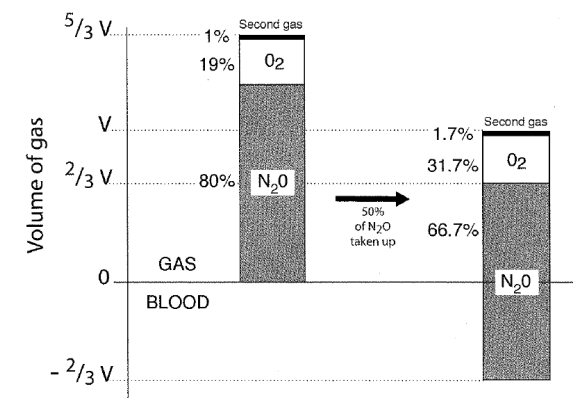

## THE EXTRA-INSPIRED VENTILATION

From the time he first gave his explanation of the concentration and second gas effects, Eger routinely invoked the twin mechanisms of the *concentrating effect* and the *extra inspired ventilation*. Presumably because the concentration effect was greater with the more soluble agent ether than with nitrous oxide<sup>1</sup>, he postulated that the extra-inspired ventilation is more important for more soluble agents, while based on the findings shown in Figure 3, the concentrating effect is more important for less soluble agents. Thus, the extra-inspired ventilation became a standard component of discussions of these effects with the clear message that it is always present.

## A MATTER OF RELATIVITY

The question of whether an extra-inspired ventilation is always a part of gas exchange was the subject of many conversations with my friend Ian Ritchie. Ritchie was then an Associate Professor of Chemistry at the University of Western Australia. He pointed out that it depends where the observer is located. If the observer is located at the alveolar-capillary junction, large volumes of different gases are constantly flowing in both

<sup>f</sup> This depends on how one measures the concentration effect. It is possible to show that when inspired concentrations are chosen so as to produce a similar contraction in gas volume, the effect is actually greater for the less soluble agent, nitrous oxide. This involves using 25% ether in a comparison with 70% nitrous oxide.

directions. During induction of anaesthesia with a gaseous agent, the net movement of anaesthetic gas is into blood. The observer stationed there will perceive that more anaesthetic gas is drawn down the airway to replace that taken up by blood. This must always occur at the interface between gas and blood if anaesthetic uptake is to proceed without interruption.

However, we anaesthetists are not stationed at the alveolar-capillary membrane. We are standing beside our patients and observing events from the outside. This is associated with a different perspective which will now be considered.

## RESPIRATORY PATTERN DURING N<sub>2</sub>O ANAESTHESIA

Kety<sup>1</sup>, Mapleson<sup>2</sup> and Eger<sup>3</sup> all treated the functional residual capacity (FRC) as remaining constant during anaesthetic uptake. Any changes in volume due to gas uptake can then only be reflected in such models by differences between the inspired and expired ventilation. In particular,  $\dot{V}_{IA}$ , the inspired alveolar ventilation, must exceed  $\dot{V}_{EA}$ , the expired alveolar ventilation. This gives rise to two possible extreme patterns of respiration. These have been named *constant inflow* and *constant outflow*<sup>9</sup>.

### Constant inflow

In this pattern, the inspired tidal volume is kept constant and the expired tidal volume allowed to vary, reflecting the gas uptake during the breath.

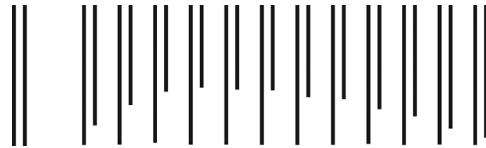

**Figure 6. Constant inflow**

Reproduced with permission from Korman and Mapleson<sup>13</sup>.

In Figure 6, each pair of vertical lines represents the volume of an inspiration followed by the accompanying expiration. Inspiratory volume is the same for each breath. Expiratory volume varies, depending on the net gas volume uptake during that breath. The first pair of lines shows the situation before the anaesthetic gas is introduced when the difference in volume is due to oxygen uptake exceeding carbon dioxide output and is so small as to be imperceptible. Thereafter, the differences between inspiration and expiration become apparent as large volumes of nitrous oxide are taken up by blood during induction with 70% N<sub>2</sub>O. As anaesthetic washin proceeds,  $F_A / F_I$  approaches 1 and the expired tidal volume slowly returns to its pre-induction value. The situation is approximated clinically by a constant volume ventilator which delivers the same volume with each breath.

### Constant outflow

At the other extreme, we have a constant outflow pattern in which the expired tidal volume is fixed, and the inspired tidal volume allowed to vary.

**Figure 7. Constant outflow**

Reproduced with permission from Korman and Mapleson<sup>13</sup>.

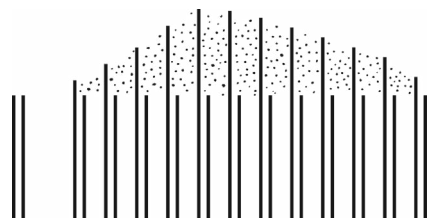

In Figure 7, the second line in each pair represents the constant expired tidal volume. To maintain the expired tidal volume constant, it is necessary for the inspired tidal volume to exceed it. The amount by which the inspired tidal volume exceeds that expired is the volume of nitrous oxide uptake during that breath. This volume is indicated by the stippled area and may be thought of as being *drawn into the airway* to maintain the sum of the FRC and expired tidal volume at a constant value. We can therefore identify this gas as Eger's extra-inspired ventilation.

<sup>9</sup> The terms "constant inflow" and "constant outflow" were first suggested by Professor Alex Robertson, Foundation Professor of Mathematics at Murdoch University, Western Australia.

This pattern is approximated clinically by a spontaneously breathing subject attempting to maintain a constant arterial  $P_{CO_2}$ .

## EGER'S CONSTANT INFLOW MODEL

It is important to note that while Eger produced equations of the form of Equations 1-3 for the constant outflow case (which he equated to a nonrebreathing system<sup>h</sup>), he also produced the following equation for the constant inflow case:

$$Cg_n = \frac{V_L \cdot Cg_{n-1} + V_I \cdot F_I - u_n}{V_L + V_I \cdot F_I - u_n} \quad (4)$$

Equations 2 and 3 were applied as before. On rearrangement, this system of equations gives rise to a quadratic equation which is solved for  $u_n$ . In this system also, the higher the inspired concentration, the more rapid the approach to the final concentration but not as fast as with Equations 1-3<sup>4</sup>. Eger attributed the reduction in rate to the limited inflow associated with the use of a circle system<sup>i</sup>. He commented that the solution "is not difficult, but cumbersome".

## RESPIRATORY PATTERN AND THE EGER-STOELTING DIAGRAM

After gas in the lung is fully equilibrated with blood, we may draw the following version of the corrected Eger-Stoelting diagram to illustrate the difference between the two extreme respiratory patterns<sup>13</sup>. In Figure 8, we have again applied the rule that half the nitrous oxide be taken up. Note that the constant inflow case is associated with a smaller uptake of nitrous oxide than the equivalent constant outflow case (160 ml compared with 267 ml). This is a feature of constant inflow and reflects the limitation on inflow referred to by Eger. When we apply the rule that half the nitrous oxide be taken up, the final concentration is the same with both patterns.

Once the FRC is fixed, the only possible patterns are constant inflow, constant outflow and all combinations thereof. Since the concentration effect occurs in both extreme cases, it follows that it must occur in all combinations thereof. But there is no extra-inspired ventilation with constant inflow. As a result, the extra-inspired ventilation cannot be credited with causing the concentration and second gas effects. Instead, we must look for some other property common to both constant inflow and constant outflow. That property, evident in all our figures from Figure 4 to Figure 8, is a shrinkage in volume and the associated *concentrating effect*. Thus, we conclude that the concentration and second gas effects are *always* caused by the concentrating effect that accompanies net gas volume uptake.

**Figure 8. Constant inflow and constant outflow using Eger's diagram**

Reproduced with permission from Korman & Mapleson<sup>13</sup>.

A-B: Inspired tidal volume is kept constant and equal to 400 ml. C-D: Expired tidal volume is kept constant and equal to 400 ml. BE = Before Equilibration; AE = After Equilibration. The gradations on each side of the y-axis occur at intervals of 20% of the inspired tidal volume for each case, that is at intervals of 80 ml for the constant inflow case and 133.3 ml for the constant outflow case.

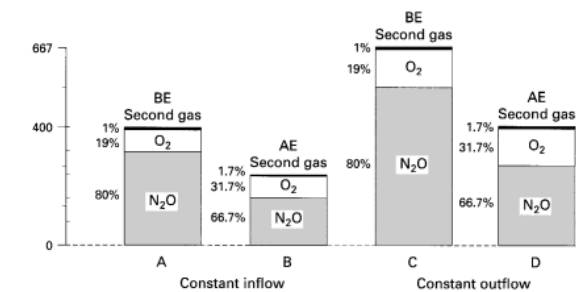

<sup>h</sup> This is incorrect as a non-rebreathing system used with a constant volume ventilator actually has a constant inflow pattern.

<sup>i</sup> Again, this is wrong since a subject breathing spontaneously on a circle system with an adequate fresh gas flow will have a constant outflow pattern of respiration.

## SHOULD EGER HAVE KNOWN?

Eger's presentation at the 1962 conference chaired by Papper and Kitz was immediately followed with a commentary given by Herbert Rackow<sup>14</sup>. He referred to previous work published by his group in 1959 in the *Journal of Applied Physiology* in which the authors described the performance of different ventilators during emergence from nitrous oxide anaesthesia<sup>15</sup>. In doing so, he actually presented the constant inflow and constant outflow patterns. He went on to comment that he thought this was part of Eger's concentration effect.

Strangely, neither Eger nor Rackow seems to have made the connection. For year after year, Eger went on explaining the concentration effect, repeatedly using his diagram and always invoking an extra-inspired ventilation. In 1971, Rackow finally described the situation during induction of anaesthesia with the different ventilators,<sup>16</sup> but the different respiratory patterns he described received little further attention and gradually faded into history.

In 1974, I came across Eger's diagram in Scurr and Feldman's *Scientific Foundations of Anaesthesia*<sup>17</sup>. At the time, I was a junior registrar in the Department of Anaesthesia at the Royal Perth Hospital. The diagram appealed to me – so simple, so elegant! It was only a year or so later that I became suspicious of the diagram and asked Ian Ritchie if he could see any flaw in the reasoning. He came back to me after 2 two weeks and pointed out the failure to equilibrate the extra-inspired ventilation. It took many more years to "join the dots" and I finally presented a talk entitled "The vacuum theory of anaesthesia" at the 1996 World Congress of Anaesthesiology in Sydney. In the talk, I focussed on the message conveyed by Eger's diagram, the message that there is always an extra-inspired ventilation during nitrous oxide anaesthesia and asked the question "How can this be when most of us use a constant volume ventilator during anaesthesia?". Edmond Eger and John Severinghaus<sup>1</sup> were both present.

By this time, I had approached Bill Mapleson for help to bring the inaccuracy in Eger's diagram to the attention of both teachers and authors. The next year our collaboration finally bore fruit when our article entitled "Concentration and second gas effects – can the accepted explanation be improved?" was published in the *British Journal of Anaesthesia*<sup>k13</sup>. Following this, Eger's diagram virtually disappeared from those anaesthetic textbooks published outside the United States. Within the United States, the diagram continued to be produced regularly by Eger until his death. One of the few concessions he made to our criticism is contained in his chapter: "Inhaled Anesthetics: Uptake and Distribution in the seventh edition of *Miller's Anesthesia*<sup>18</sup>. In this edition, he wrote:

"This explanation has been criticized as being overly simplistic and ignoring the realities of some aspects of ventilation. For example, if ventilation is controlled with a volume-limited respirator, an augmentation in inspired ventilation is limited to the period of the expiratory pause. Spontaneous ventilation minimizes this limitation. In any event, the reader needs to be aware that although Figure 4 describes the basic factors governing the concentration and second gas effects, the actual situation is more complex."

Of course, the exact opposite is true. The situation is much simpler – uptake of significant volumes of gas concentrates all remaining gases in a smaller volume; this increases their partial pressures and accelerates their uptake. The only complexity has been introduced by Eger himself in persisting with a diagram that is wrong. So confused has the picture become, that Calvey and Williams, when alluding to the concentration effect in their chapter on inhalational anaesthetic agents in *Principles and Practice of Pharmacology for Anaesthetists* seem too scared to actually offer an explanation. Instead they state: "The cause of this phenomenon is obscure"<sup>19</sup>.

American authors other than Eger continue to reproduce the diagram uncritically. Sometimes the diagram is disguised but the explanation remains the same as in the following example by Forman and Benkowitz<sup>20</sup>:

## Figure 9. The Forman and Benkowitz version of Eger's diagram

Reproduced with permission from the copyright owners McGraw-Hill Health Inc.

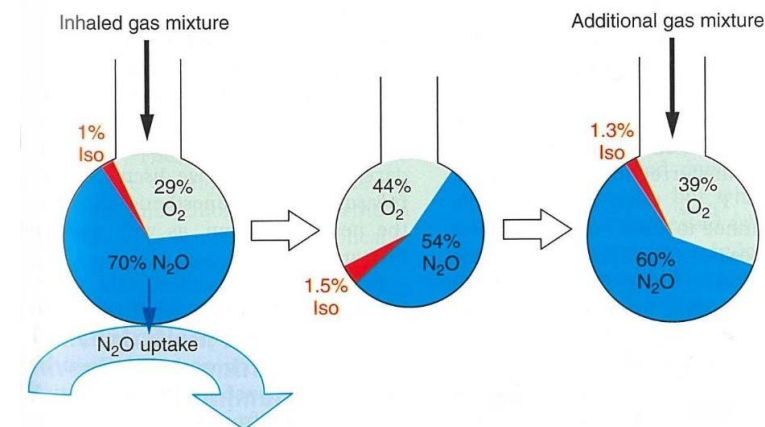

Other times the diagram remains unchanged, but the explanation is altered as in this extract from the chapter by Ebert and Naze<sup>21</sup> in *Clinical Anesthesia*:

"In this hypothetical example, the second gas is set at 2% of a potent anesthetic and the model is set for 50% uptake of the first gas, nitrous oxide in the first inspired breath. The second gas is concentrated because of the uptake of nitrous oxide (middle panel). On replenishing the inspired second gas in the next breath, the second gas has been concentrated to be 2.7% because of the uptake of nitrous oxide in the previous breath."

In the version of the Eger-Stoelting diagram accompanying this explanation, the second gas concentration starts at 2% in the first panel, rises to 3.1% in the second and finishes up at 2.7% in the third. Note however, that the dilution in the third panel is now ascribed to the next breath implying that one respiratory cycle consists of *inspiration-expiration-inspiration*. Does this mean that the next respiratory cycle consists of *expiration-inspiration-expiration*? Surely this is a classic case of trying to make the facts fit the theory! One can only feel pity for the poor anaesthesia trainee trying to make sense of these explanations.

## CONCLUSION

The Eger-Stoelting diagram is often used as a teaching tool. The steps in the diagram do not match those taken in the mathematical model used by Eger to predict the existence of the concentration effect. The concentration and second gas effects are best explained as follows: *Uptake of significant volumes of gas concentrates each remaining gas in a smaller volume; this increases its partial pressure and accelerates its uptake. In the case of CO<sub>2</sub> its elimination from blood is slowed.* No diagram is necessary but if one is to be included Figure 5 above, is sufficient.

Whenever large volumes of gas disappear into blood during gas uptake a significant difference may arise between the inspired and expired tidal volume of each breath. When modelling anaesthetic uptake with a fixed FRC, two extreme patterns of respiration are recognisable: *constant inflow* and *constant outflow*. Each of these exhibits the concentrating effect as shown in Figure 8. Any combination of these two patterns will therefore exhibit a concentrating effect.

Instead of asking what changes needed to be made to Kety's model to produce the concentration and second gas effects, Eger remained satisfied with his own explanation of the cause of these phenomena and continued to use a flawed diagram as a teaching tool long after the flaw had been pointed out. This shows us that old ideas should not be automatically accepted as correct without critical analysis, even when they originate from acknowledged experts. One does not have to be an academic do this – even the most junior of trainees can challenge long-held ideas if they don't seem to make sense. Indeed, it should be regarded as obligatory to do this instead of simply regurgitating textbook material as is frequently done during exams. It is often said that "One picture is worth 1000 words". Eger's diagram shows exactly what can happen when the picture is wrong!

j Well-known anaesthesiology research worker and inventor of the Severinghaus PCO<sub>2</sub> electrode.

k This may be viewed at: [https://bjanaesthesia.org/article/S0007-0912\(17\)39990-7/fulltext](https://bjanaesthesia.org/article/S0007-0912(17)39990-7/fulltext)  
An earlier version of this paper had previously been rejected by ANESTHESIOLOGY.

## REFERENCES

1. Kety SS. The Theory and applications of the exchange of inert gas at the lungs and tissues. *Pharmacol Rev* 1951. 3: p. 1-41.
2. Mapleson WW. An Electric analogue for uptake and exchange of inert gases and other agents. *J Appl Physiol* 1963. 18: p. 197-204.
3. Eger EI. A Mathematical model of uptake and distribution. In: Papper EM and Kitz RJ, editors. *Uptake and Distribution of Anesthetic Agents*. New York: McGraw-Hill; 1963. p. 72-87.
4. Eger EI. Applications of a mathematical model of gas uptake. In: Papper EM and Kitz RJ, editors. *Uptake and Distribution of Anesthetic Agents*. New York: McGraw-Hill; 1963. p. 88-103.
5. Eger EI. Effect of inspired anesthetic concentrations on rate of rise of alveolar concentration. *Anesthesiology* 1963; 24: 153-7.
6. Epstein RM, Rackow H, Salanitre E, Wolf GL. Influence of the concentration effect on the uptake of anesthetic mixtures - the second gas effect. *Anesthesiology*. 1964; 25: 364-71.
7. Heller ML, Watson TRJ, Imredy DS. Effect of nitrous oxide uptake on arterial oxygenation. *Anesthesiology*. 1967; 28: 904-13.
8. Kitahata LM, Taub A, Conte AJ. The effect of nitrous oxide on alveolar carbon dioxide tension: a second-gas effect. *Anesthesiology*. 1971; 35: 607-11.
9. Stoelting RK, Eger EI. An Additional explanation for the second gas effect: a concentrating effect. *Anesthesiology*. 1969; 30: 273-7.
10. Chinard FP, Enns T, Nolan MF. Diffusion and solubility factors in pulmonary inert gas exchanges. *J Appl Physiol*. 1961; 16: 831-6.
11. Forster RE. Diffusion factors in gases and liquids. In: Papper EM and Kitz RJ, editors. *Uptake and Distribution of Anesthetic Agents*. New York: McGraw-Hill; 1963. p. 20-9.
12. Korman B. Binary Solutions in Anaesthesia. MD thesis. Melbourne; 1994. p. 166.
13. Korman B, Mapleson WW. Concentration and second gas effects: can the accepted explanation be improved? *Br J Anaesth*. 1997; 78: 618-25.
14. Rackow H. Discussion of Lung Factors, Applications of a Mathematical Model of Gas Uptake. In: Papper EM and Kitz RJ, editors. *Uptake and Distribution of Anesthetic Agents*. New York: McGraw-Hill; 1963. p. 98-103.
15. Rackow H, Salanitre E, Frumin MJ. Dilution of alveolar gases during nitrous oxide excretion in man. *J Appl Physiol*. 1961; 16: 723-8.
16. Salanitre E, Rackow H. Recent advances in uptake and excretion of inhalation anesthetics. In: Fabian LW, editor. *Clinical Anesthesia - A Decade of Clinical Progress*. Philadelphia: FA Davis; 1971. p. 179-85.
17. Eger EI. Uptake, distribution, and elimination of inhaled anaesthetics. In: Scurr C and Feldman S, editors. *Scientific Foundations of Anaesthesia*. London: William Heinemann; 1974. p. 444-53.
18. Eger EI. Inhaled anesthetics: uptake and distribution. In: Miller R, editor. *Miller's Anesthesia*. Philadelphia: Elsevier Health Sciences; 2010. p. 543.
19. Calvey TN, Williams NE. Principles and Practice of Pharmacology for Anaesthetists. Massachusetts: Blackwell Publishing Inc.; 2008. *Inhalational Anaesthetic Agents*; p. 136-7.
20. Forman SA, Benkwitz C. Inhalational Anesthetics. In: Longnecker DE, *Anesthesiology*, D.E. Longnecker, Mackey SC, Newman MF, Sandberg WS, Zapol WM, editors. China: McGraw-Hill Education; 2018. p. 551-70.
21. Ebert TJ, Naze SA. Inhaled Anesthetics. In: Barash PG, Calahan MK, Cullen BF, Stock MC, Stoelting RK, Ortega R, Sharar SR, Holt N, editors. *Clinical Anesthesia*. 8<sup>th</sup> edition. Philadelphia: Wolters Kluwer; 2017. p. 459-83.

# Circulation

## **Atrial fibrillation, ablation, and the anaesthetist**

Cameron Maxwell, Derek Potgieter, Thomas Bruessel

---

## **Bubble trouble: Vascular gas embolism**

Bridget Devaney

---

## **The expanding role of SGLT-2 inhibitors in the treatment of heart failure**

Aaron Pym, Ross Hanrahan, Peter Flynn, Thomas Bruessel

---

## **Anaesthesia for the adult patient with a Fontan circulation undergoing non-cardiac surgery**

Reza Yusoff, James Preuss, Shannon Matzelle, Cameron Seamen

---

## **Anaesthetic considerations in the patient with Eisenmenger syndrome**

Michael H Toon, Cameron Graydon

---

## **Right ventricular failure – when the right heart goes wrong**

Richella-Lea Falland, Kate Drummond, Nicole Wylie

---

## **Management of right ventricular dysfunction after separation from cardiopulmonary bypass**

Mumtaz Khan, Michael Scerri

---

## **The perioperative management of patients with ventricular assist devices undergoing non-cardiac surgery**

Richella-Lea Falland, David Sidebotham, Sara Jane Allen

---

## Atrial fibrillation, ablation, and the anaesthetist

### Cameron Maxwell, BSc MChD MMed

Department of Anaesthesia, Perioperative Medicine and Pain Management, Canberra Health Service, ACT, Australia

Dr Cameron Maxwell is an advanced trainee at Canberra Hospital. His interests include education and teaching, cardiothoracic anaesthesia, and retrieval medicine.

### Derek Potgieter, MBBCh FCA (South Africa) FANZCA

Department of Anaesthesia, Perioperative Medicine and Pain Management, Canberra Health Service, ACT, Australia

Dr Derek Potgieter is a staff specialist at Canberra Hospital and clinical lecturer at the Australian National University. His interests include cardiothoracic anaesthesia and electrophysiology.

### Thomas Bruessel, Dr med, FANZCA

Department of Anaesthesia, Perioperative Medicine and Pain Management, Canberra Health Service, ACT, Australia

Professor Thomas Bruessel is the Director of the Department of Anaesthesia, Perioperative Medicine and Pain Management at Canberra Health Services and Chair of Anaesthesia at the Australian National University. He has strong interests in regional anaesthesia, neuro-anaesthesia and neuro medicine.

## INCIDENCE AND PROJECTIONS

Atrial fibrillation (AF) is the most common arrhythmia and has significant health and socioeconomic impact. In Australia it affects 500,000 people and an estimated 5 per cent of the over 55 years age group suffer from it<sup>1</sup>. AF is a major risk factor for new-onset heart failure, stroke, dementia and mortality. The impact of AF is also increasing with the proportion of AF related deaths doubling from 4.6 per cent in 2001 to 9 per cent in 2018. AF has significant economic effects with almost one billion dollars, or 1 per cent of the health budget, being spent on the diagnosis and treatment of AF in 2019<sup>2</sup>.

## EFFECTS ON THE PATIENT

Apart from the increased risk of stroke, dementia, heart failure and overall mortality, AF greatly impairs quality of life. Similar degrees of quality-of-life impairment are seen in patients with recent myocardial infarction and heart failure, emphasizing the importance of effective AF management<sup>3</sup>. Quality of life can be assessed in four domains: physical condition, psychological well-being, social activities, and everyday living. AF has wide ranging effects on the four domains secondary to AF symptoms as well as general chronic disease impacts. The detrimental effect on quality of life is a major driver to seek management and consequently treatment aims to improve quality of life.

## LIFESTYLE MODIFICATION

A key component to the successful treatment of AF is lifestyle modification and aggressive risk factor management. Common risk factors include smoking, alcohol consumption, physical inactivity, obstructive sleep apnoea (OSA) and obesity. Large trials<sup>4,5</sup> have demonstrated the importance of weight reduction (>10% weight loss) and moderate regular exercise. OSA should be screened for and if diagnosed continuous positive airway pressure (CPAP) therapy initiated. It is prudent to check CPAP adherence. Hypertension, hyperthyroidism, hyperlipidaemia, and diabetes must be screened for and treatment initiated, aiming for a BP < 130/80 and HbA1c < 6.5%. Smoking cessation and abstinence from alcohol should also be encouraged.

## MEDICAL MANAGEMENT

The two major goals for medical management of AF include preventing thromboembolic events and managing symptoms with rate or rhythm control. Anticoagulants are used to reduce thromboembolic events and treatment is initiated based on risk. A commonly used risk scoring system is CHA<sub>2</sub>DS<sub>2</sub>-VASc (see Table 1)<sup>6</sup> with a score greater or equal to 2 used as the threshold for anticoagulation. Bleeding continues to be a major limitation to initiating and/or continuing anticoagulation therapy.



**Table 1. CHA<sub>2</sub>DS<sub>2</sub>-VASc risk scoring system**

Risk factor	Score
Congestive heart failure/LV dysfunction	1
Hypertension	1
Age ≥75 years	2
Diabetes mellitus	1
Stroke/Transient ischemic attack/Thromboembolism	2
Vascular disease (prior myocardial infarction, or peripheral vascular disease)	1
Age 65-74 years	1
Sex category (female gender)	1

Rate control therapy choice is based on several factors including haemodynamic status, underlying cardiac function, duration of AF and comorbidities. Beta blockers are the most prescribed rate control agent and are also useful in patients with impaired left ventricular function. Digoxin and non-dihydropyridine calcium channel blockers are also used.

Rhythm control therapy modifies cell excitability, conductivity, or abnormal automaticity via various ion channels. When administered early they have a high rate of successful conversion to sinus rhythm. Long term use requires careful consideration of contraindications and side effects. Amiodarone is commonly used, although the adverse and irreversible effects are numerous and include thyroid dysfunction, pulmonary toxicity and liver function derangement. Sotalol is also used, particularly in patients with structurally normal hearts, hypertension and/or coronary artery disease.

## APPENDAGE OCCLUSION

Left atrial appendage occlusion is a consideration in the management of thromboembolic risk and AF in patients with a contraindication to anticoagulation. The left atrial appendage is a common site for the formation of thrombus. The occlusion device (clip, suture, or implant) is placed percutaneously via a venous sheath and a transseptal puncture. The PROTECT-AF trial<sup>7</sup> showed a non-inferior rate of cardiovascular death and stroke between warfarin and an appendage occlusion device. There are several issues that exist with the use of appendage occlusion devices. Patients still require a period of anticoagulation and antiplatelet therapy to reduce the risk of device related thrombus. The period for epithelization of the device is variable and the occurrence and management of device related thrombus is still largely unknown. Furthermore, patients still require rate or rhythm control to treat symptoms associated with AF.

## INDICATIONS FOR AF ABLATION

Indications for AF ablation are shown in Table 2. Most patients who undergo AF ablation will be symptomatic with paroxysmal or persistent AF who are refractory to or intolerant of antiarrhythmic drugs. AF ablation is also considered in a variety of other conditions and patient populations. In concomitant AF and heart failure with reduced ejection fraction, ablation has been shown to reduce mortality and hospitalisation for heart failure when compared with medical therapy<sup>8</sup>.

**Table 2. Indications for AF ablation**

Adapted: 2020 European Society of Cardiology Guidelines<sup>9</sup>.

<b>Class I</b>	Symptomatic paroxysmal AF which is refractory to medical management
	Tachycardia-induced cardiomyopathy secondary to AF to reverse LV dysfunction
	Symptomatic persistent AF (refractory)
<b>Class IIa</b>	Symptomatic paroxysmal AF (first line therapy)
	Heart failure with reduced ejection fraction
	Tachycardia-bradycardia syndrome
	Athletes
<b>Class IIb</b>	Symptomatic persistent AF (first line therapy)
	Can also be considered in asymptomatic patients and patients with associated psychological stress

Some patients with paroxysmal AF develop sinus pauses at the time of spontaneous cardioversion. This may be symptomatic and can deteriorate with drugs used for rate control. Catheter ablation of paroxysmal AF has been consistently shown to reduce both symptomatic and asymptomatic tachycardia-bradycardia in these patients<sup>10</sup>. This can often reduce the need for both rate control drugs and permanent pacemakers.

Athletes are a special patient population that require optimal cardiac performance. As such athletes may poorly tolerate AF and effective treatment is required. Rate control agents are not recommended due to the limitation on maximum heart rate and may be prohibited in professional sport. Rhythm control agents or AF ablation are therefore the preferred first line treatment.

As mentioned above AF greatly impairs quality of life. When comparing AF ablation to medical therapy, the CAPTAF<sup>11</sup> trial showed a significant and sustained improvement in quality of life at 12 months. The CABANA<sup>12</sup> trial found a similar result, extending to 24 months. The most common factor influencing quality of life is anxiety related to the disease and psychological distress is common in patients referred for AF ablation.

AF is a significant risk factor for cognitive impairment independent of its effect on the risk for stroke. The mechanism of AF and cognitive impairment is still unclear but likely relates to silent cerebral infarcts, microbleeds associated with anticoagulation and cerebral hypoperfusion. AF ablation has been shown to improve neurocognitive function at one year, particularly in patients with pre-ablation cognitive decline<sup>13</sup>. Although early studies suggested that AF ablation was associated with post procedural neurocognitive abnormalities, techniques have since changed. Uninterrupted perioperative anticoagulation before and for three months following surgery, activated clotting time (ACT) of 350-400 seconds during the procedure and reducing left atrial dwell time with newer technologies may improve outcomes in this regard<sup>13</sup>.

## LIMITATIONS OF AF ABLATION

The main limitations of AF ablation are recurrence and complications. Recurrence is more likely in patients with persistent AF, unmanaged risk factors for AF and structural changes to the heart. The HATCH Score (see Table 3) predicts progression from paroxysmal to persistent AF and new onset AF after AF ablation<sup>14</sup>.

**Table 3. HATCH Score**

Risk factor	Score
Hypertension	1
Age ≥75 years	1
Transient ischaemic attack or stroke	2
Chronic obstructive pulmonary disease	1
Heart failure	2

Increasing left atrial size and patient frailty are additional risks for the progression of paroxysmal to persistent AF. Structural remodelling of the left atrium also predicts recurrence. "AF begets AF" is a term used to describe the changes in AF making cure less likely.

Elderly patients are underrepresented in treatment of AF by ablation. Patients over 75 years make up 50 per cent of the community AF burden, yet less than 10 per cent undergo AF ablation in many centres. AF ablation in elderly patients is safe although somewhat less effective often leading to multiple procedures<sup>15</sup>.

## ABLATION VERSUS MEDICAL MANAGEMENT AND RECENT TRIALS

Two landmark trials have been published in recent years examining AF ablation and medical management of AF. The Catheter Ablation versus Antiarrhythmic Drug Therapy in Atrial Fibrillation trial (CABANA)<sup>12</sup> compared the safety and efficacy of the above treatments. The primary outcome was death, disabling stroke, serious bleeding, or cardiac arrest at 48 months. Although the primary outcome demonstrated non-superiority of AF ablation to drug therapy, there was considerable crossover which confounded the assessment. Subgroup analysis showed that patients that received AF ablation had a significant reduction in death, cardiovascular hospitalisations, recurrent AF, and AF burden. Furthermore, symptomatic patients (NYHA class II-IV) and patients with preserved ejection fraction heart failure had improved primary outcomes with AF ablation.

The Early Rhythm-Control Therapy in Patients with Atrial Fibrillation trial (EAST-AFNET 4)<sup>16</sup> compared the safety and efficacy of rhythm control to usual care. Rhythm control therapy included AF ablation and/or rhythm control agents, while usual care was limited to rate control agents. Importantly, to be enrolled in the trial patients had to be diagnosed with AF within 12 months. The primary outcome was cardiovascular death, stroke, hospitalisation for heart failure, or acute coronary syndrome. The trial was stopped early due to efficacy with all primary outcomes showing reductions with rhythm control therapy. The rhythm control group was somewhat evenly distributed between AF ablation (19 per cent), amiodarone, dronedarone (not available in Australia) and flecainide.

## IMPORTANCE OF PULMONARY VEINS

The pathophysiological basis of AF is complex and not completely understood. The classical AF mechanism involves a single ectopic focus triggering a single re-entry circuit and multiple wave re-entry leading to persistent AF. Through complex atrial mapping techniques, novel concepts have been developed which suggest that stable or unstable fibrosis-linked rotors and epicardial-endocardial dissociation are important for the maintenance of AF<sup>17</sup>. A rotor is a phase singularity (core) whose reverberations cause spiral waves that radiate into surrounding tissues leading to fibrillatory conduction. Understanding the source of AF triggers and maintenance areas is crucial in determining targets for ablation.

The landmark paper by Haissaguerre<sup>18</sup> explored the source of spontaneous ectopic beats triggering initiation of atrial fibrillation. Forty-five patients with paroxysmal AF refractory to drug therapy were recruited and underwent atrial mapping with multi electrode catheters. Sixty-nine ectopic foci were identified (some patients had more than one ectopic focus) and most ectopic foci were located within the superior pulmonary veins.

**Figure 1. Diagram of the sites of 69 ectopic foci triggering atrial fibrillation in 45 patients**

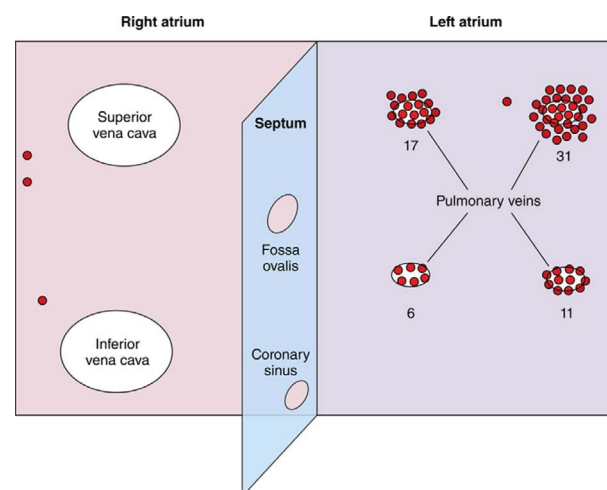

## OTHER SOURCES

Unfortunately, the pulmonary veins are not the only source of ectopic foci. Non-pulmonary vein triggers include mitral and tricuspid periannular regions, the crista terminalis and Eustachian ridge, the interatrial septum, the left atrial posterior wall, the left atrial appendage, and other thoracic veins such as the superior vena cava, the coronary sinus, and the ligament of Marshall. Non-pulmonary vein sources create challenges in AF ablation as they may be the cause of procedure failure if not located and treated.

AF ablation is generally more successful in patients with paroxysmal AF. Likely the transition from paroxysmal to long standing persistent AF is a continuum. In paroxysmal AF, the relative role of focal pulmonary vein triggers is high, so pulmonary vein isolation is generally successful. With progression to long standing persistent AF greater importance is on non-pulmonary vein triggers, rotors, scar interaction, and epi-endo dissociation. Therefore, more complex mapping of the atrium is required to localise ablation targets and break the cycle of AF triggering and maintenance in persistent AF.

## ABLATION TECHNIQUES

AF ablation involves placement of intravascular catheters, electroanatomic mapping to identify sources of AF, navigation systems to aid catheter manipulation, and ablation to isolate the pulmonary veins with different ablation energies and strategies.

### CT scan

The cornerstone of successful AF ablation is pulmonary vein isolation from the left atrium. Unfortunately, challenges are created by the highly variable anatomy of the pulmonary veins and left atrium. Pre-operative cardiac CT scanning attempts to overcome this challenge by accurately imaging the left atrium and pulmonary veins. The CT images can then be integrated with fluoroscopy images to guide catheter ablation. Recent data suggests that the use of pre-operative CT imaging when combined with electroanatomic mapping does not improve safety or efficacy of AF ablation, and leads to additional radiation exposure<sup>19</sup>.

### Electroanatomic mapping

Electroanatomic mapping involves creating a map of the heart to guide real-time catheter manipulations and ablation. Intracardiac electrograms measure electrical signals to assess activation sequence, and signal amplitude to assess tissue health. Anatomical three-dimensional mapping allows creation of a detailed cardiac chamber map and accurate catheter location. Data is collected and stored to allow pinpoint reproducible locations. Electroanatomic mapping is used in radiofrequency ablation and is not required in cryoablation as fluoroscopy and transoesophageal echocardiography (TOE) are used to guide the catheter.

### Ablation equipment

The pulmonary veins are accessed via the left atrium. To access the left atrium, multiple venous sheaths are placed in large central veins, typically femoral, and catheters are directed to the right atrium. A transseptal puncture is required to pass the catheters from the right to left atrium. Two transseptal punctures are required for radiofrequency ablation as the mapping catheter is not integrated into the radiofrequency ablation catheter.

Radiofrequency and cryoablation are the two most used ablation energies. Radiofrequency ablation involves delivery of thermal energy, typically 30-50W, via direct contact leading to tissue necrosis. The standard radiofrequency ablation strategy is point-by-point wide-area circumferential pulmonary vein isolation. Confirmation of pulmonary vein isolation is via elimination of the pulmonary vein spike potential recorded by the mapping catheter. Three-dimensional electroanatomic mapping of the left atrium is required, which leads to generally longer procedures and more catheter manipulation. Advances in radiofrequency technology have been developed to improve the success and safety of the method. Direct contact is required for successful ablation however excessive pressure may lead to energy delivery to non-cardiac structures. Contact force sensors have been integrated to the radiofrequency catheter to improve effective delivery of energy to the myocardium. Integrated cooling systems have also been developed to allow a consistent energy delivery, and to reduce thrombus formation and steam pop.

Cryoablation involves placing a balloon at the pulmonary vein ostium and, through direct contact, delivering cryothermal energy creating ice and tissue necrosis, leading to pulmonary vein isolation. An integrated circular mapping catheter is present in the distal tip to allow measurement of ectopic electrical signals. The placement of the cryoballoon into the pulmonary veins is guided by fluoroscopy and/or TOE. It is a generally less time-consuming procedure and has demonstrated noninferiority to radiofrequency ablation (FIRE and ICE trial<sup>20</sup>).

## Figure 2. Cryoablation (top image) and radiofrequency ablation (bottom image) at the pulmonary vein-atrial junction

Source: FIRE and ICE trial<sup>20</sup>. Reproduced with permission.

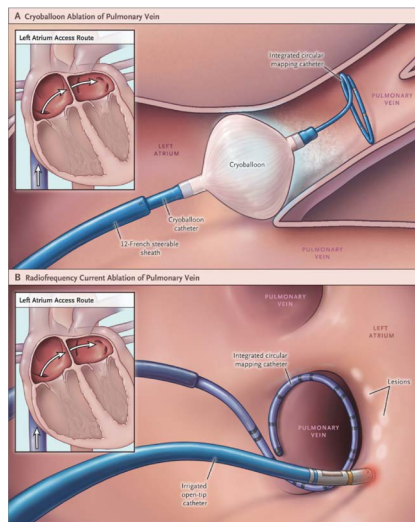

### Transoesophageal echocardiography (TOE)

TOE is used to exclude atrial and left atrial appendage thrombus prior to commencing the procedure. An overview of chamber size and function, as well as heart valves is useful information. It is important to evaluate the pericardial space for later comparison to exclude new pericardial fluid.

Guided by TOE, the interatrial septum is crossed to gain access to the left atrium. The puncture should be done in the central thin part of the fossa ovalis. Usually, two views are used concurrently, the 4-chamber view and a bicaval view. In the 4-chamber view, advancing to about 30 degrees will help to view the fossa and the aortic valve simultaneously. The bicaval view will show the catheter retracting down the superior vena cava into the right atrium while the fossa is in view. Tenting of the septum reveals the site of the needle. The needle should be directed away from the aorta and in a shallow atrium, the posterior atrial wall is at risk of puncture. Manometry is also used to measure chamber pressure, and this will rise if the aorta is punctured.

### Figure 3. Left image shows tenting in the thin septum in a safe location away from the aorta and aortic valve. Right image shows the bicaval view with the cephalad aspect on the right side of the image

Note the catheter can be seen in the IVC and passes into the SVC. LA: left atrium. RA: right atrium. IVC: inferior vena cava. SVC: superior vena cava

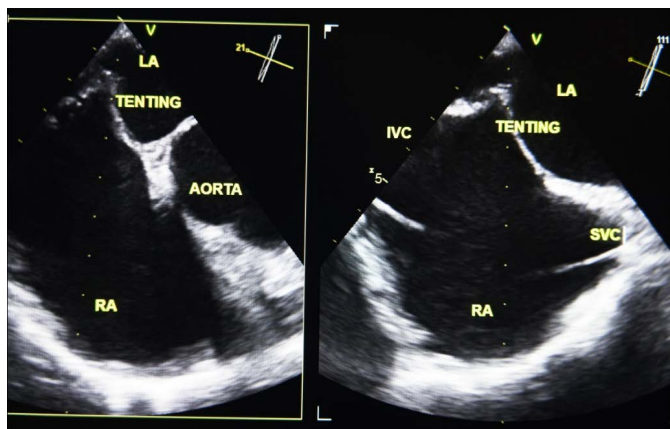

Pulmonary vein anatomy and catheter position can be confirmed. In repeat ablations, pulmonary vein stenosis should be excluded, as it is a known complication of AF ablation. Pulmonary vein anatomy is usually imaged by CT scan and catheter-based mapping systems; however, TOE can also be used.

Limitations include obscuring of the transeptal catheter position on fluoroscopy. The TOE probe also must be removed prior to ablation, to allow monitoring of oesophageal temperature. The usual risks of TOE remain, including oesophageal injury, dental damage, and sore throat.

### PERIOPERATIVE ANTICOAGULATION

Patients undergoing AF ablation are at risk for periprocedural thrombotic events, including stroke and cognitive dysfunction. They are also at risk of bleeding, with groin complications as well as cardiac tamponade. AF ablation was typically performed with cessation of vitamin K antagonists (VKA) with or without bridging therapy. Novel anticoagulant (NOAC) therapy has become more commonly used and this was typically ceased for 24-48 hours prior to AF ablation. When the catheters were within the left atrium, heparin was used to keep ACT 300-400 seconds.

More recent studies suggest that AF ablation without discontinuation of VKA's reduces periprocedural stroke and minor bleeding relative to bridging with low molecular weight heparin. Uninterrupted NOAC therapy is as effective as uninterrupted VKA and may have a lower risk of major bleeding complications. Dabigatran appears to have the least bleeding complications and reversal is available for emergency use.

In uninterrupted anticoagulated patients, heparin should still be administered, usually a bolus of 100u/kg after septal puncture. The ACT should be kept above 300 seconds and repeated every 10-15 minutes until this is achieved, and then every 15-30 minutes until the end of the procedure.

Patients should resume regular anticoagulation for at least eight weeks following AF ablation.

### ANAESTHESIA

Patients should be warned of sore throat, secondary to intubation, TOE, and temperature probes. Chest pain after ablation is common but usually mild or moderate in severity. Groin pain at cannulation sites is common but also mild to moderate in severity and subsides after a few hours when sutures or compression dressings are removed. Bladder catheterisation should be considered, particularly with irrigated ablation techniques. Patients are nursed in a recumbent position for several hours following groin cannulation. Invasive arterial blood pressure monitoring is usually advised. Oesophageal temperature should be measured with the probe adjusted as close to the ablation site as possible. Changes can occur rapidly and the proceduralist must be advised immediately of any change.

The EP lab is a remote location and has a large amount of specialised, unfamiliar and radiation emitting equipment. Successful AF ablation requires a host of staff that are in and outside the lab, therefore communication and teamwork are essential. Teams controlling mapping systems, catheter position analysis, pacing, and ablation switching and setting are in an adjacent control room; while staff managing irrigation equipment, point of care ACT measurement, and cardioversion/defibrillation are inside the room. Communication is a problem and may be overcome by headsets for all staff. Screens should be capable of receiving multiple inputs for sharing of haemodynamic variables, temperature measurements, TOE images, fluoroscopy images, electrophysiological measurements, mapping images, ablation settings and delivery, and catheter force/direction. In addition, ablation irrigation volumes and urine volumes require communication as the room is cramped for space and the fields are sterile. Procedures take a few hours and vigilance is required by everybody.

Studies have demonstrated that AF ablation under either conscious or deep sedation is possible, but general anaesthesia is preferred due reduced recurrence rates<sup>21</sup>. The procedure is painful and patient movement is required to be at the absolute minimum possible.

Where endocardial mapping techniques and referenced catheters are used, map shifts occur with patient movement relative to the magnet which is attached to the operating bed. Muscle relaxants can be used for intubation, but particularly in cryoablation, care should be taken to ensure that phrenic nerve pacing is possible by restricting the dose and allowing time for neuromuscular blocker recovery. Remifentanyl is a useful agent to reduce movement without the need for neuromuscular blocking agents.

## VENTILATION

In point-by-point radiofrequency ablation, each point is important and effective ablation relies on four factors to achieve ablation temperature in the tissue. The energy power setting, time of delivery, contact force of the catheter and catheter stability. Of these, the most difficult to control is catheter stability.

Conventional ventilation causes movement of the lungs, causing movement of other organs in the chest and ultimately, movement of the ablation catheter. Ineffective ablation causes endocardial oedema, making subsequent ablation less effective. High frequency jet ventilation has become the standard in many institutions, with evidence of increased ablation success<sup>22</sup>. Sophisticated equipment such as the Monsoon Jet Ventilator (Acutronic Medical Systems AG, Hirzel, Switzerland) is used. This pressure hose is typically connected to a specialised luer lock elbow connected to the endotracheal tube with the adjustable pressure limiting (APL) valve fully open. Initial ventilation is started at 120-130 breaths per minute with a driving pressure of 15-20psi and 60-100 per cent oxygen. Transcutaneous carbon dioxide monitoring is advised and correlated to blood gas analysis. Endocardial mapping should be performed when ventilation is settled as changes will produce a map shift. This ventilation can cause haemodynamic change and vasopressors are frequently required. Volatile anaesthesia cannot be used during jet ventilation so equipment for TIVA is required.

More recently and driven by barriers to the adoption of jet ventilation, a technique of high frequency low volume ventilation utilising a standard ventilator has been adopted in many institutions<sup>23</sup>. Tidal volumes of 200-250ml and respiratory rates of 40-50 breaths per minute have been shown to significantly reduce variation in ablation catheter contact force. Inspiratory times should be significantly reduced, and expiratory flow should approach zero at end expiration to avoid air stacking and hypotension. This is tolerated by most patients and normal capnography techniques can be used, albeit with an increased end tidal to arterial carbon dioxide gap. This technique allows for the use of volatile anaesthesia and can be used with muscle relaxants or with remifentanyl infusion, as required.

### Other factors

Temperature monitoring is essential with an oesophageal temperature probe placed as close to the ablation point as possible. New equipment allows multiple simultaneous point temperature measurements. Preoperative CT scanning can help to predict which vein ablations are likely to be closest to the oesophagus. Patient warmers should not cause electrical interference to the mapping system. Forced air warmers and some direct current resistive gel underbody warmers are acceptable. In fact, all electrical devices and even metal objects placed close to the patient can cause electromagnetic interference and should be cleared by the mapping scientists prior to use. Once electrical isolation of the pulmonary veins from the left atrium has been confirmed by pacing within the pulmonary veins, this conduction can be stress tested by the administration of adenosine or isoprenaline. Protamine is often administered at the conclusion of surgery to aid groin haemostasis. Regular anticoagulants are resumed six hours following surgery and proton pump inhibitors are prescribed twice daily for six weeks.

Patients require ECG monitoring overnight and regular monitoring for groin complications and tamponade.

## COMPLICATIONS

Approximately 2 per cent of patients undergoing AF ablation may experience major complications including stroke, oesophageal injury, cardiac tamponade, and pulmonary vein stenosis<sup>24</sup>.

### Postoperative expectations

Pain post AF ablation is reasonably common but short lived. In one study 60 per cent of patients reported moderate pain in the first 24 hours<sup>25</sup>. Most common was back pain, likely related to a long procedure in the supine position, followed by groin, chest, and throat pain.

### Tamponade and cardiac injury including pulmonary vein stenosis

Cardiac tamponade is a major life-threatening complication of AF ablation and occurs at an incidence of 1 per cent<sup>24</sup>. It can occur at multiple stages of the procedure including transseptal puncture, catheter manipulation and energy deployment. Most of the time it can be treated with reversal of anticoagulation and percutaneous drainage, although occasionally urgent surgical drainage is required. Predictors of cardiac tamponade include ablation technology, ablation strategy and the number of procedures per patient<sup>26</sup>. Radiofrequency ablation conveys the highest risk, likely related to the multiple transseptal punctures required. Ablation beyond pulmonary vein isolation also increases the risk of cardiac tamponade as the procedure is longer, with more catheter manipulations and greater energy deployment.

Pulmonary vein stenosis occurs in 0.5 per cent of procedures and, if unrecognised, can lead to chronic pulmonary hypertension, lung damage and right heart failure<sup>27</sup>. It is theorised that risk factors for pulmonary vein stenosis include extensive ablation, multiple ablative procedures, small pulmonary veins prior to ablation or an increase in pulsed wave doppler velocity pre- and post-ablation. Diagnosis is often delayed due to the non-specific early symptoms, so a high index of suspicion is required. Management of pulmonary vein stenosis is also challenging with a high rate of restenosis regardless of treatment modality (balloon angioplasty, bare or drug eluting stents).

### Groin complications

AF ablation requires insertion of one or more vascular sheaths into, typically, the femoral vein. Vascular complications are therefore not uncommon, occurring in 2 per cent of patients<sup>28</sup>. This includes pseudoaneurysm, arteriovenous fistula and haematoma formation. Generally vascular complications are managed conservatively however in cases of life-threatening bleeding urgent surgical intervention is required.

### Oesophageal injury

The oesophagus is closely related to the posterior wall of the left atrium, separated by only 1 mm of fat, and therefore is at risk of thermal injury during AF ablation. Left atrial-oesophageal fistula formation is a well-recognised complication with an incidence of 0.1 per cent. Although uncommon, it represents significant morbidity and, if unrecognised, has a mortality rate greater than 90 per cent. Ulceration and erythema of the oesophagus is reasonably common but generally resolves with proton pump inhibitor therapy and time. Strategies have been developed to reduce the risk of oesophageal injury, including limiting magnitude of power and duration of ablation. Given the variable thickness of the posterior wall of the left atrium and the fat layer separating the oesophagus, luminal oesophageal temperature monitoring is also used. If temperatures greater than 38.5C are measured, ablation should be interrupted, lower power settings adopted, and ablation should restart when the temperature falls below 38.5C. Using this strategy, oesophageal injury may be reduced from 36 per cent to 6 per cent<sup>29</sup>.

### CNS problems, POCD and stroke

Neurological complications occur at an incidence of 1 per cent<sup>28</sup> and include stroke, transient ischemic attack (TIA) and phrenic nerve injury. The cause of stroke and TIA is multifactorial and can be secondary to patient and surgical factors. Patient factors include non-paroxysmal AF, older age, history of stroke, diabetes, and female sex<sup>28</sup>. Ischemic stroke can occur secondary to catheter manipulation and transseptal puncture, while the use of intraoperative heparin (required to reduce thromboembolism) can predispose to haemorrhagic stroke. Air bubbles in irrigated ablation also pose a risk.

Patients presenting for AF ablation have commonly already been prescribed anticoagulants to reduce the risk of thromboembolic complications such as stroke. Guidelines state warfarin and NOACs should be continued in the perioperative period<sup>30</sup>, although there is significant local practice variation. Discontinuation of warfarin is a major risk factor for stroke/TIA. Surprisingly, continuation of warfarin in the perioperative period leads to no change in major bleeding events and a reduction of minor bleeding events, likely due to the requirement of bridging low weight molecular heparin<sup>31</sup>.

The phrenic nerve is nestled between the superior vena cava and the right superior pulmonary vein. It is therefore not surprising that the phrenic nerve can be injured during AF ablation. Its incidence varies significantly with procedure type, with the highest incidence occurring with cryoballoon ablation (5 per cent). This is likely due to the balloon placement within the right superior pulmonary vein and therefore closer associated with the phrenic nerve. Phrenic nerve injury can also occur during radiofrequency ablation secondary to direct heat transfer and the increased susceptibility of the phrenic nerve to heat energy, although the incidence is lower (0.5 per cent)<sup>28</sup>.

### Fluoroscopy time and dose

AF ablation relies on the use of fluoroscopy and therefore patients are exposed to radiation. Radiation dose varies with fluoroscopy system settings and fluoroscopy time which relates to complexity of procedure, operator experience and non-fluoroscopic techniques for catheter location (TOE, 3D mapping systems). Large studies have found average fluoroscopy times to be 20 minutes with 386 milligrays (mGy) of radiation exposure<sup>32</sup>. For comparison, an adult abdominal CT scan exposes the patient to 10 mGy and average yearly exposure is around 5 mGy. Although difficult to quantify in real-world terms it has been estimated that the lifetime risk of fatal malignancies after one hour of fluoroscopy is 0.07 per cent for male and 0.1 per cent for female patients<sup>32</sup>.

### Reconnections and intra operative testing

Pulmonary vein isolation is the cornerstone of AF ablation and pulmonary vein reconnection can lead to increased AF recurrence and repeat procedures. Reconnection can occur due to incomplete pulmonary vein isolation or via dormant pulmonary vein conduction pathways. It is therefore important that during the initial procedure that these pathways are discovered and ablated to improve success and reduce recurrence of AF.

Adenosine hyperpolarises pulmonary veins leading to restoration of tissue excitability, which unmasks dormant pulmonary vein conduction and partially ablated pathways. Typically, 50 per cent of patients will have dormant pulmonary vein conduction unmasked during adenosine administration. This can then guide further ablation and has been shown to reduce the rate of recurrence<sup>33</sup>. Adenosine is given after pulmonary vein isolation and can be repeated until no further connections can be uncovered.

Isoprenaline is used to identify non-pulmonary vein triggers for AF. Non-pulmonary vein triggers may originate from, but are not limited to, the superior vena cava, coronary sinus, and interatrial septum. Observational studies suggest that ablation of non-pulmonary vein triggers improves success rates but in practice inducing, identifying, and eliminating these triggers is challenging. The benefit of isoprenaline is likely in repeat procedures where standard pulmonary vein isolation has been unsuccessful.

### Failure and repeat procedures

Failure is an unfortunate event with any medical procedure and AF ablation is no different. Patients with paroxysmal AF have the highest success rate (75 per cent) and the lowest are seen in patients with long-lasting persistent AF (67 per cent)<sup>28</sup>. Success rate is improved with the continued use of antiarrhythmic therapies. Repeat procedures occur in approximately 10 per cent of patients, largely for recurrent AF.

## CONCLUSION

AF is the most common arrhythmia and continues to cause significant health and socioeconomic burden. As such novel management strategies and refinement of current management techniques will continue to develop. AF ablation is one area of rapid growth with changes to technology and surgical technique leading to increased success rates and therefore more patients being offered the procedure. AF ablation is unique as anaesthetic technique can affect the likelihood of a successful procedure. As its use becomes more widespread, anaesthetists will encounter this procedure more often and therefore must understand the challenges and conduct of AF ablation.

## REFERENCES

- Ball J, Thompson DR, Ski CF, Carrington MJ, Gerber T, Stewart S. Estimating the current and future prevalence of atrial fibrillation in the Australian adult population. *Med J Australia*. 2015 Jan; 202: 32–6.
- Australian Institute of Health and Welfare. Disease expenditure in Australia. [Internet]. Canberra: Australian Institute of Health and Welfare; 2019 [cited 2021 Mar 21]. Available from: <https://www.aihw.gov.au/reports/health-welfare-expenditure/disease-expenditure-australia/contents/summary>.
- Dorian P, Jung W, Newman D, Paquette M, Wood K, Ayers GM, et al. The Impairment of health-related quality of life in patients with intermittent atrial fibrillation: implications for the assessment of investigational therapy. *J Am Coll Cardiol*. 2000 Oct; 36: 1303–19.
- Pathak RK, Middeldorp ME, Lau DH, Mehta AB, Mahajan R, Twomey D, et al. Aggressive risk factor reduction study for atrial fibrillation and implications for the outcome of ablation: the ARREST-AF cohort study. *J Am Coll Cardiol*. 2014 Dec; 64: 2222–31.
- Pathak RK, Elliott A, Middeldorp ME, Meredith M, Mehta AB, Mahajan R, et al. Impact of cardiorespiratory fitness on arrhythmia recurrence in obese individuals with atrial fibrillation: the CARDIO – FIT study. *J Am Coll Cardiol*. 2015 Sep; 66: 985–96.
- Lip G, Nieuwlaet R, Pisters R, Lane DA, Crijns H. Refining clinical risk stratification for predicting stroke and thromboembolism in atrial fibrillation using a novel risk factor-based approach: The Euro Heart Survey on atrial fibrillation. *Chest*. 2010 Feb; 137: 263–72.
- Reddy VY, Sievert H, Halperin J. Percutaneous left atrial appendage closure vs warfarin for atrial fibrillation: a randomized clinical trial. *JAMA*. 2014 Nov; 312: 1988–98.
- Marrouche NF, Brachmann J, Andresen D, Siebels J, Boersma L, Jordaens L, et al. Catheter ablation for atrial fibrillation with heart failure. *NEJM*. 2018 Feb; 378: 417–27.
- Hindricks G, Potpara T, Dagres N, Arbelo E, Bax JJ, Blomstrom-Lundqvist C, et al. 2020 ESC Guidelines for the diagnosis and management of atrial fibrillation developed in collaboration with the European Association for Cardio-Thoracic Surgery (EACTS): The Task Force for the diagnosis and management of atrial fibrillation of the European Society of Cardiology (ESC) Developed with the special contribution of the European Heart Rhythm Association (EHRA) of the ESC. *Eur Heart J*. 2021 Feb; 42: 373–498.
- Inada K, Yamane T, Tokutake K, Yokoyama K, Mishima T, Hioki M, et al. The role of successful catheter ablation in patients with paroxysmal atrial fibrillation and prolonged sinus pauses: outcome during a 5-year follow-up. *Europace*. 2014 Feb; 16: 208–13.

- Blomstrom-Lundqvist C, Gizurarson S, Schwieler J, Jensen SM, Bergfeldt L, Kenneback G, et al. Effect of catheter ablation vs antiarrhythmic medication on quality of life in patients with atrial fibrillation: the CAPTAF randomized clinical trial. *JAMA*. 2019 Mar; 321: 1059–68.
- Packer DL, Mark DB, Robb RA, Monahan KH, Bahnson TD, Poole JE, et al. Effect of catheter ablation vs antiarrhythmic drug therapy on mortality, stroke, bleeding, and cardiac arrest among patients with atrial fibrillation: the CABANA randomized clinical trial. *JAMA*. 2019 Mar; 321: 1261–74.
- Jin MN, Kim TH, Kang KW, Yu HT, Uhm JS, Joung B, et al. Atrial fibrillation catheter ablation improves 1-year follow-up cognitive function, especially in patients with impaired cognitive function. *Circ Arrhythm Electrophysiol*. 2019 Jul; 12: e007197.
- Vos C, Pisters R, Nieuwlaet R, Prins M, Tieleman R, Coelen R, et al. Progression from paroxysmal to persistent atrial fibrillation clinical correlates and prognosis. *J Am Coll Cardiol*. 2010 Feb; 55: 725–31.
- Kautzner J, Peichl P, Sramko M, Cihak R, Aldhoon B, Wichterle D. Catheter ablation of atrial fibrillation in elderly population. *J Geriatr Cardiol*. 2017 Sep; 14: 563–8.
- Kirchhof P, Camm AJ, Goette A, Brandes A, Eckardt L, Elvan A, et al. Early rhythm-control therapy in patients with atrial fibrillation. *NEJM*. 2020 Oct; 383: 1305–16.
- Iwasaki Y, Nishida K, Kato T, Nattel S. Atrial fibrillation pathophysiology. *Circulation*. 2011 Nov; 124: 2264–74.
- M Haïssaguerre, P Jaïs, D C Shah, A Takahashi, M Hocini, G Quiniou, et al. Spontaneous initiation of atrial fibrillation by ectopic beats originating in the pulmonary veins. *NEJM*. 1998 Sep; 339: 659–66.
- Di Cori A, Zucchelli G, Faggioni L, Segreti L, De Lucia R, Barletta, et al. Role of pre-procedural CT imaging on catheter ablation in patients with atrial fibrillation: procedural outcomes and radiological exposure. *J Inter Card Electrophysiol*. 2020 May. Online ahead of print.
- Kuck KH, Brugada J, Furnkranz A, Metzner A, Ouyang F, Chun J, et al. Cryoballoon or radiofrequency ablation for paroxysmal atrial fibrillation. *NEJM*. 2016 Jun; 374: 2235–45.
- Di Biase L, Conti S, Mohanty P, Bai R, Sanchez J, Walton D, et al. General anaesthesia reduces the prevalence of pulmonary vein recurrence during repeat ablation when compared with conscious sedation: results from a randomized study. *Heart Rhythm*. 2011 Mar; 8: 368–72.
- Elkassabany N, Garcia F, Tschabrunn C, Raiten J, Gao W, Chaichana K, et al. Anaesthetic management of patients undergoing pulmonary vein isolation for treatment of atrial fibrillation using high frequency jet ventilation. *J Cardiothorac Vasc Anesth*. 2012 June; 26: 433–8.
- Gabriels J, Donnelly J, Khan M, Anca D, Beldner S, Willner J. High frequency, low tidal volume ventilation to improve catheter stability during atrial fibrillation ablation. *JACC Clin Electrophysiol*. 2019 Oct; 5: 1224–6.
- Bertaglia E, Zoppo F, Tondo C, Colella A, Mantovan R, Senatore G, et al. Early complications of pulmonary vein catheter ablation for atrial fibrillation: a multicenter prospective registry on procedural safety. *Heart Rhythm*. 2007 Oct; 4: 1265–71.
- Bode K, Breithardt OA, Kreuzhuber M, Mende M, Sommer P, Richter S, et al. Patient discomfort following catheter ablation and rhythm device surgery. *EP Europace*. 2015 July; 17: 1129–35.
- Chun J, Perrotta L, Bordignon S, Khalil J, Dugo D, Konstantinou A, et al. Complications in catheter ablation of atrial fibrillation in 3000 consecutive procedures: balloon versus radiofrequency current ablation. *JACC Clin Electrophysiol*. 2017 Feb; 3: 154–61.
- Raeisi-Giglou P, Wazni OM, Saliba WJ, Barakat A, Tarakji KG, Rickard J, et al. Outcomes and management of patients with severe pulmonary vein stenosis from prior atrial fibrillation ablation. *Circ Arrhythm Electrophysiol*. 2018 May; 11: e006001.
- Arbelo E, Brugada J, Blomstrom-Lundqvist C, Laroche C, Kautzner J, Pokushalov E, et al. Contemporary management of patients undergoing atrial fibrillation ablation: in-hospital and 1-year follow-up findings from the ESC-EHRA atrial fibrillation ablation long-term registry. *Eur Heart J*. 2017 May; 38: 1303–16.
- Singh SM, D'Avila A, Doshi SK, Brugge WR, Bedford RA, Mela T, et al. Esophageal injury and temperature monitoring during atrial fibrillation ablation. *Circ Arrhythm Electrophysiol*. 2008 Aug; 1: 162–8.
- Calkins H, Hindricks G, Cappato R, Kim Y, Saad E, Aguinaga L, et al. 2017 HRS/EHRA/ECAS/APHS/SOLAECE expert consensus statement on catheter and surgical ablation of atrial fibrillation. *Europace*. 2018 Jan; 20: 1–160.
- Biase LD, Burkhardt JD, Santangeli P, Mohanty P, Sanchez JE, Horton R, et al. Periprocedural stroke and bleeding complications in patients undergoing catheter ablation of atrial fibrillation with different anticoagulation management: results from the Role of Coumadin in Preventing Thromboembolism in Atrial Fibrillation Patients Undergoing Catheter Ablation randomized trial. *Circulation*. 2014 Jun; 129: 2638–44.
- Lickfett L, Mahesh M, Vasamreddy C, Bradley D, Jayam V, Eldadah Z, et al. Radiation exposure during catheter ablation of atrial fibrillation. *Circulation*. 2004 Oct; 110: 3003–10.
- Macle L, Khairy P, Weerasooriya R, Novak P, Verma A, Willems S, et al. Adenosine-guided pulmonary vein isolation for the treatment of paroxysmal atrial fibrillation: an international, multicentre, randomised superiority trial. *Lancet*. 2015 Aug; 386: 672–9.

# Bubble trouble: Vascular gas embolism

## Dr Bridget Devaney FACEM, MBChB, DipDHM

Emergency Physician in the Emergency & Trauma Centre and Acting Head of Unit, Hyperbaric at The Alfred hospital, Melbourne

Dr Devaney has a keen interest in research on necrotising soft tissue infections, and quality improvement in healthcare.

### INTRODUCTION

Vascular gas embolism (VGE) is a potentially life-threatening event which occurs when gas enters the vascular system. Historically this was primarily a condition associated with rapid ascent from diving or submarine escape training, particularly with breath being held and subsequent over-expansion pulmonary barotrauma causing disruption of the pulmonary vasculature and entry of gas into the vascular system. Over recent years advances in technological complexity and invasiveness of modern therapeutics have led to VGE becoming a predominantly iatrogenic condition. VGE has been documented to occur in an extremely broad range of procedures. In the author's experience alone, causes of VGE in cases referred for Hyperbaric Oxygen Treatment (HBOT) range from air being inadvertently delivered under pressure during a resuscitation scenario, placement and removal of central venous access, loose perma-cath connections, lung transplantation and other cardiothoracic surgical procedures, gastroscopy and hysteroscopy, among others. It is difficult to provide accurate data on the true incidence of gas embolism and this is unlikely to ever be accurately known. The absolute quantity of gas entrained (or delivered) in VGE varies with each case; the type of gas although most commonly air, varies and as a result the behaviour of the gas bubbles may also vary. The end location of a gas embolus may be venous, pulmonary or arterial; it may have anywhere from minimal to abundant collateral circulation, differing metabolic requirements for oxygen as well as differing susceptibility to the vascular inflammatory changes that occur following the passage of bubbles. For these reasons both physiological effects and clinical findings in VGE may show extreme variation, from asymptomatic to cardiac arrest to catastrophic brain injury or death. At times, VGE may be suspected and for a variety of reasons not escalated or the suspicion not acted on. It is important to increase awareness of the condition as well as to foster a "speak-up" culture in order to avoid delays in diagnosis and the associated poor outcomes.

Our organisation provides the only public hyperbaric service for the state of Victoria and historically has treated an average of two cases of VGE per year. It is likely that substantially more events than this occur, and only the most severe are referred for HBOT. In fact, possibly in part due to improved awareness and recognition of the significance of gas embolism events, nine cases were treated over the year 2020, more than any preceding year.

### PATHOPHYSIOLOGY

Vascular gas embolism may be venous, arterial, or initially venous with subsequent arterialisation via intra-cardiac or intra-pulmonary shunting; known as paradoxical embolism. Bubbles may enter the cerebral circulation via the arteries or veins and cerebral gas embolism will be discussed separately below.

#### Arterial gas embolism

Air may enter the arterial circulation directly or indirectly. Direct arterial gas embolism occurs when gas is directly entrained or delivered into the arterial circulation, for example, during cerebral angiography, open chamber cardiac surgery, or bypass circuit accidents. Indirect or paradoxical arterial air entry occurs when venous gas translocates across a shunt which may be intra-cardiac (for example, PFO, ASD), intra-pulmonary (generally via overwhelming the pulmonary capillary bed's filtering capacity, but also reported as having occurred via intrapulmonary arterio-venous anastomoses), or other (for example, atrial-oesophageal fistulae although this is rare<sup>1</sup>).

Signs and symptoms of arterial gas embolism are determined by many factors, primarily the amount and distribution of gas, and while extremely variable, reflect the occlusion of portions of the vasculature. Neurologic deficits may occur (usually rapidly) and include loss of consciousness, stupor and confusion, unilateral or bilateral motor and/or sensory changes, gait disturbance, headache, vertigo, dizziness, and visual field defects or blindness. Pulmonary symptoms such as chest pain and shortness of breath may occur. Cardiac arrest may occur.

## Venous gas embolism

Pre-conditions for entry of gas into the venous system include opening of the non-collapsing veins to the atmosphere and the presence of sub-atmospheric pressure within these vessels<sup>2</sup>. The epiploic veins, emissary veins and dural venous sinuses are examples of non-collapsing veins. Other causes of venous gas embolism are procedures in which the surgical site is under pressure, or where the surgical wound is situated above the level of the heart such that venous pressure is sub-atmospheric and passive entry of air is enabled<sup>3</sup>. Veins within a coagulated operative field may also allow entry of air. Air may enter veins through central venous or haemodialysis catheters, primarily on insertion or removal, but also due to material separation, detachments, breaks or cracks in the lines. The veins of the myometrium during pregnancy and after delivery seem to be particularly susceptible to entrainment of air.

The rate of entrainment of gas is important. Most commonly, a slow steady, string-of-pearls type arrangement of bubbles enter the venous system. At rates of up to 10mL/min the majority of bubbles are filtered out by the pulmonary capillaries<sup>4</sup>. If a rapid bolus or particularly large volume of air is entrained into the venous circulation, pulmonary arterial pressures rise, leading to increased resistance to right ventricular outflow and diminished pulmonary venous return. In turn left ventricular pre-load is reduced as is cardiac output; and systemic cardiovascular collapse may occur. Tachyarrhythmias often develop and bradycardias are also possible. Given the altered resistance of lung vessels, the mismatch between ventilation and perfusion causes intrapulmonary right-to-left shunting and increased alveolar dead space, leading to arterial hypoxia and hypercapnia.

## Cerebral gas embolism

Cerebral arterial gas embolism (CAGE) may occur via a range of mechanisms; direct injection of gas into the cerebral arterial system during angiography or indirect (paradoxical) embolism via intracardiac, intrapulmonary, or other shunting. Pulmonary barotrauma can also enable entry of gas into the pulmonary veins, left heart and subsequently the cerebral circulation. Peripheral *venous* air bubbles may ascend in a retrograde fashion against venous flow into the cerebral venous system.

Studies looking at air within the cerebral arterial circulation demonstrated that when air is injected into carotid arteries in animal models, 80 per cent of bubbles can be collected in jugular vein air traps within several cardiac cycles<sup>5,6</sup>. With relatively high cerebral arterial systolic pressure, and an almost two-fold difference in diameter of the venous end of a cerebral capillary compared to the arterial end (9 vs 5 microns) bubbles are essentially sucked through the capillaries into the veins rapidly.

CAGE is often a biphasic phenomenon, and an initial, temporary neurologic dysfunction is likely due to the passage or transient lodgement of bubbles within the cerebral circulation. It is common to have a period of recovery after the majority of bubbles are cleared to the jugular veins. Many patients (Gorman reports up to 65 per cent<sup>7</sup>) with CAGE exhibit a secondary deterioration which may not occur for several hours after insult and is the result of the interaction between gas bubbles and vessel walls; consisting of endothelial damage, activation of leucocytes and platelets, extravasation of fluid and activation of the clotting cascade and complement systems. These events lead to vascular inflammation, microhaemorrhages, secondary thrombotic occlusions, capillary leakiness and oedema<sup>2,8</sup> as well as brain lipid peroxidation secondary to PMNL diapedesis<sup>7</sup>, bubble regrowth, and secondary vasospasm.

Larger intra-arterial cerebral bubbles may lodge at vessel branch-points, and these are redistributed substantially more slowly in a pulsatile fashion with systole over two to five minutes. Bubbles within loop and anastomotic vessels, where systolic pressure applies at both ends, are more likely to remain trapped, as are extremely large bubbles which occupy many generations of arterioles. In these cases (which make up approximately 30 per cent of cases of arterial gas embolism) ischaemia, infarction and a sustained loss of neurological function consistent with a stroke syndrome, is more likely to occur<sup>7</sup>.

Neurologic deficits vary widely due to the distribution of bubbles in the cerebral circulation. If bubbles are distributed to the brainstem this can lead to cardiorespiratory arrest and is frequently lethal.

## DIAGNOSIS OF VASCULAR GAS EMBOLISM

The diagnosis of iatrogenic gas embolism is a predominantly clinical one; a high degree of suspicion and attention to physiologic variables must be maintained during procedures in which gas embolism is a known risk. Given the biphasic nature of signs and symptoms, one should not be falsely reassured by a resolution of physiologic or other change.

In procedures in which gas embolism is a known risk, clinicians should be alert to the audible sucking in of air or visible entrainment through lines or cannulae.

Clinical findings such as a rapid fall in blood pressure, sudden changes in heart rate (tachy- or bradycardia), arrhythmias, cardiovascular collapse, decreased peripheral oxygen saturation, or a sudden sustained fall in BIS or cerebral oximetry should raise suspicion of cerebral arterial gas embolism. Decreased end tidal CO<sub>2</sub> suggests the altered relationship between perfusion and ventilation due to obstruction of the pulmonary vessels. Transient or persistent ST changes may suggest gas moving through, lodging within or causing inflammatory changes to the endothelium of a coronary vessel. Seizure activity may occur.

A conscious patient might report chest pain, shortness of breath, cough, confusion or headache. A splashing precordial auscultatory sound, the classic “mill-wheel” murmur, may be heard with a precordial or oesophageal stethoscope, caused by froth in the cardiac chambers and great vessels<sup>2,9</sup>.

Cardiopulmonary symptoms have been reported to be significantly higher in patients with venous source of air compared to an arterial source<sup>10</sup> including tachypnoea, hypocapnia, pulmonary oedema and cardiac arrest.

Where gas is introduced directly into the arterial system, symptom onset is immediate whereas if it is via arterialisation of venous bubbles, the onset is delayed, as the process depends on an increase in pulmonary artery pressure and right heart pressures secondary to gas embolism of the pulmonary arteries. Arterial gas embolism may result in confusion, loss of consciousness or focal neurological deficits, cardiac arrhythmias or ischaemia.

The diagnosis can be challenging, and other features that support the diagnosis should be taken into account, for example, evidence of intravascular gas on ultrasound, direct observation (gas aspirated from a central venous line), or circumstances consistent with gas embolism occurrence such as high-risk surgeries.

The gold standard for detection of air embolism is transoesophageal echocardiography due to its ability to detect as little as 0.02mL/kg of air<sup>11</sup>. However, given that the outcome of vascular gas embolism is highly dependent which vessels gas passes through or lodges in, in addition to many other factors, there is no clearly specified threshold of intra-vascular air (either venous or arterial) which is significant.

Most advanced radiological techniques have a high false negative rate for CAGE, even in the context of severe neurological deficits, and diagnosis should *not* depend on imaging results. Obtaining imaging delays time to definitive treatment (recompression) and is generally *not* recommended, particularly in cases highly suggestive of CAGE<sup>3,7,12</sup>. The main role of cerebral imaging would only be to exclude other causes that may present like an AGE, for example, an intracerebral haemorrhage.

While signs and symptoms of arterial gas embolism are relatively easily detected when occurring in the previously well and conscious diver, this is clearly not the case for patients under anaesthesia with an iatrogenic gas embolism; detection and subsequent treatment of a likely gas embolism event often does not occur until the patient is woken post-operatively. Given the implication of delays to treatment on recovery, it is critical that a high degree of vigilance and meticulous monitoring of clinical parameters is maintained during high-risk procedures; especially in those cases following which the patient may not be woken or able to be assessed immediately post operatively.

## MANAGEMENT

### First aid

Immediate priorities in the management of iatrogenic vascular gas embolism include resuscitation, prevention of further air entrainment and efforts to remove or halt the progress of already entrained air, where possible.

In an anaesthetised patient, the airway should be secured with an endotracheal tube if not already done. The inspired fraction of oxygen should be increased to 1.0, and adequate ventilation maintained in order to maintain arterial oxygenation and to facilitate de-nitrogenation and resorption of bubbles. Normovolaemia should be maintained to optimise the microcirculation and vasopressor or inotropic support should be commenced if required to maintain blood pressure. Inotropic support of the right ventricle may be indicated in venous gas embolism induced haemodynamic dysfunction. Cardiac resuscitation may be required. In venous gas embolism cardiac massage may force air from the pulmonary outflow tract into smaller vessels and allow improved blood flow.

Entrainment of further gas should be prevented. Gas pressurised spaces such as pneumoperitoneum, should be decompressed. Nitrous oxide, if in use, should be ceased as it can expand gas filled intravascular space. Aspiration of intravascular gas may be attempted via an in-situ central venous catheter, however there is no data to support insertion of a catheter to aspirate gas if one is not already in-situ.

Historically, the Trendelenburg position was recommended for patients with arterial gas embolism, based on the beliefs that the weight of the column of blood above would force bubbles through the cerebral capillary bed, the buoyancy of bubbles would keep bubbles located within the aorta or heart, and bubbles in the spinal cord might be compressed by the weight of spinal fluid above, however these theories were never experimentally confirmed.

Large air emboli have been demonstrated to increase intracranial pressure from 12 to 52mmHg within two hours of insult, with severe detrimental effects on brain oxygenation and glucose metabolism<sup>13</sup>. Butler et al demonstrated that Trendelenburg position did not keep bubbles from being distributed to the systemic circulation and can worsen cerebral oedema<sup>14</sup>, and Trendelenburg positioning is no longer routinely recommended. If the patient is awake or has a protected airway, they should be placed in the supine position, or lateral decubitus if unconscious with an unsecured airway. However, in the event of a right ventricular outflow tract occlusion by gas embolism, immediate placement into the left lateral decubitus and Trendelenburg position may relieve the air-lock and move the air into the right atrium<sup>11</sup>.

### Hyperbaric Oxygen Treatment

Hyperbaric Oxygen Treatment (HBOT) is the only definitive treatment for arterial gas embolism and is an American Heart Association (AHA) Class I recommendation (level of evidence C) for this indication.

Many studies demonstrate clearly improved neurological examinations, neurophysiological studies and neuro-psychometric testing outcomes amongst patients with arterial gas embolism treated with hyperbaric oxygen<sup>15</sup>. Dutka et al reviewed a large number of case series of AGE and demonstrated a better prognosis among patients who received recompression compared to those who did not<sup>16</sup>.

Hyperbaric oxygen should be delivered as soon as possible after an air embolism event, as a shorter interval between embolism and recompression is associated with a higher probability of a good outcome<sup>3,10,17-21</sup>. A prospective animal study demonstrated that initiation of HBOT within one hour of symptom onset effectively mitigated brain injury from CAGE<sup>20</sup>. In Beevor and Frawley's retrospective review of 36 patients with cerebral gas embolism the only independent factor associated with good neurological outcome was time to first HBOT; HBOT within eight hours of cerebral gas embolism was associated with better neurological outcome<sup>19</sup>. Treatment delays of over six hours can still have substantial benefits<sup>22,23</sup>, and improvements have been reported in cases when HBOT is applied many hours after the gas embolism event<sup>24-26</sup>. It is likely in these instances that the HBOT effect is primarily due to modulation of post-bubble vascular inflammatory changes, rather than bubble-volume reduction. Given the biphasic nature of CAGE and the tendency for patients to deteriorate after an apparent recovery, early HBOT is recommended even for patients who appear to have spontaneously recovered<sup>13,27</sup>.

It is less clear if HBOT should be used routinely for isolated venous gas embolism. Most patients who have small venous gas emboli do well with supportive care, suggesting that HBOT is probably not indicated in those cases<sup>28</sup>. The Undersea & Hyperbaric Medical Society currently does not recommend HBOT for asymptomatic venous gas embolism<sup>29</sup>.

### Mechanism of Hyperbaric Oxygen Treatment

HBOT reduces gas bubble volume by increasing ambient pressure (Boyle's law). This may resolve the bubbles or compress them sufficiently to allow redistribution of trapped arterial bubbles to the veins, restoring blood flow. In accordance with Henry's law HBOT increases the solubility of the culprit gas enabling resorption, and increases the amount of dissolved oxygen, improving the oxygenation of potentially hypoxic tissue.

Hyperoxia creates a diffusion gradient for oxygen into the gas bubble and nitrogen out. The rate at which the bubble resolves depends on the diffusion of nitrogen out of the bubble, and transport of dissolved gases to the lungs. HBOT eliminates inspired nitrogen, and therefore raises the nitrogen partial-pressure gradient between the bubble and the surrounding tissue. This facilitates diffusion of nitrogen out to the gas phase and into solution, according to Fick's law.

Bubble volume will change in inverse proportion to the ambient pressure but reduction in bubble dimensions depend on bubble shape.

In addition to the direct and indirect effects on bubble volume, HBOT also attenuates leucocyte adhesion to damaged endothelium, favourably modulates ischaemia-reperfusion injury<sup>30,31</sup> and reduces secondary inflammation, facilitating the return of blood flow.

### Hyperbaric treatment tables

International standard of practice for treatment of air embolism is compression to 282kPa (60fsw or 18msw equivalent depth) according to US Navy Schedule Six, with the patient breathing 100 per cent oxygen. The advantages of this table are that it causes significant volume in bubble reduction, conveys an acceptable risk of oxygen toxicity, is safe for the nurse attendant both from the perspective of nitrogen narcosis as well as decompression illness, and is relatively short, and cheap. The oxygen dose delivered over the course of this treatment is associated in vivo with inhibition of PMNL diapedesis<sup>7</sup>. However, this table was derived from use in divers with decompression illness and there is an argument that the US Navy Schedule Five (equivalent pressure but shorter duration) may be sufficient in iatrogenic air embolism given that there is no inert gas load to remove. Studies comparing outcomes among patients with iatrogenic gas embolism who received USN Schedules 5 and 6 are lacking, however shorter tables designed for use in monoplace chambers have been used with success<sup>28</sup>. Repetitive treatments are recommended until there is no further stepwise improvement; often between 1-3 treatments until response plateau is reached and maintained.

### Lidocaine (lignocaine)

The use of lidocaine in arterial gas embolism is a Class IIa AHA recommendation with Level B evidence.

In 1984 Evans et al injected lidocaine followed by air to the vertebral arteries of cats and measured their sciatic/cerebral SERs. The control group SER fell to 28% of baseline and recovered to 60% and 73% at one and two hours. The treatment group SER fell to 68% of baseline and recovered to 89% and 95% at one and two hours. This difference was found to be statistically significant.

In a subsequent study also led by Evans, lidocaine was injected after the injury. Air was injected via the carotid artery until the SER was down to 10% of the baseline for a period of five minutes, after which the treatment group received a lidocaine bolus and infusion. The control group recovered to 32.6% of baseline SER, while the treatment group recovery was to 77.3% of the baseline SER. This was also statistically significant (P<0.001).

McDermott also performed several relevant studies on feline models. He showed that HBOT and HBOT + lidocaine had better SER recovery than a control group, but without additive benefit. Unfortunately, this study did not include a lidocaine-only group. McDermott also studied the additive benefit of lignocaine to HBOT in a dog model, whereby air was injected to the carotid arteries, and if the SER fell to under 10% of baseline, then dogs were recompressed with US Navy Table 6a and given lidocaine. The control group SER recovered to 32% of baseline, while the treatment group SER recovered to 60% of baseline (p<0.025)<sup>15</sup>. Lidocaine has also been found in animal models to be associated with improved outcomes in the context of other neurologic injuries, however this is beyond the scope of this chapter.

The evidence for lidocaine in humans is less impressive than the animal data. While Mitchell et al's double blinded randomised control trial of patients undergoing left heart valve procedures in 1999 demonstrated that the group receiving standard cardiac antiarrhythmic infusion of lidocaine performed compared to placebo in 6 of 11 neuropsychological tests<sup>32</sup>, the follow up study in 2009 failed to demonstrate a neuroprotective benefit in perioperative lidocaine use following cardiac surgery<sup>33</sup>. There were some flaws to the follow up study, which included a predominance of patients undergoing CABG without cardiomy, unlike the initial study which only included open chamber surgery (which has previously been shown to result in greater quantities of gas emboli).

In practice, the use of lidocaine for patients with vascular gas embolism varies. If it is to be used, evidence suggests that an appropriate endpoint is attainment of serum lidocaine concentrations consistent with an antiarrhythmic effect (2-6 mcg/mL).

### Potential mechanisms of neuroprotection by lidocaine

Lidocaine induced sodium channel blockade prevents or decelerates membrane depolarisation of hypoxic neurons.

Modulation of neuronal energy metabolism.

Inhibits leucocyte migration and accumulation in the microcirculation of reperfused ischaemic tissue.

Modulation of haemodynamic parameters.



## CONCLUSION

VGE events are a rare complication of a range of procedures, which can manifest in a variety of ways, making early detection challenging; even more so when the patient is under relaxant anaesthesia.

Strategies should be developed to prevent, detect, and rapidly treat vascular gas embolism.

Procedures which carry a high risk for gas embolism should be identified early, discussed prior to the procedure or operation as well as during the pre-procedure time-out.

Consideration should be given to patient positioning and monitoring modalities. Maintaining pre-load can help minimise risk of air entrainment. Meticulous attention to clinical parameters and a high index of suspicion must be maintained, and vigilance particularly at key risk points of the procedure. Strategies aimed at consistently reducing these risks should be developed.

Regular education of staff performing high-risk procedures should be ongoing and specific to the task, with a focus on excellent communication; both between personnel (for example, anaesthetist and surgeon, to allow rapid action to be taken if air entrainment is suspected) as well as between clinician and patient (for example, use of clear instructions during central line placement in the awake patient, such as “breathe all the way out and then hold” rather than “hold your breath”, which many interpret an instruction to take a deep breath, which increases the risk of VGE).

A “speak-up” culture should be fostered, enabling all members of the interdisciplinary team to feel comfortable to communicate concerns around patient safety.

Awareness of the nearest appropriate hyperbaric facility and smooth referral processes should be maintained, as this is the primary mode of treatment, and those who are treated earlier have more favourable outcomes. Inclusion of vascular gas embolism cases in interdepartmental SIM training is likely to be beneficial.

## REFERENCES

- Cereda C, Staedler C, Moschovitis G, Caronni F, Bassetti CL, Azzola A. Bubbles in the brain: systemic air embolism syndrome from an atrial-oesophageal fistula. *Emerg Med J.* 2011;28(5):455.
- Muth CM, Shank ES. Gas embolism. *N Engl J Med.* 2000;342(7):476-82.
- Moon RE. *Hyperbaric Oxygen Therapy Indications.* 14 ed. Florida: Best Publishing Company; 2019.
- Tunncliffe FW. The Intravenous Injection of Oxygen Gas as a Therapeutic Measure. *The Lancet.* 188(4851):321-3.
- Van Allen CM HL, Clark J. Air embolism from the pulmonary vein. *Arch Surg.* 1929;19:567-99.
- Gorman DF BD, Parsons DQ. Redistribution of cerebral arterial gas emboli: a comparison of treatment regimens. Bove AA BA, Greenbaum LJ Jr, editor. *Bethesda: Undersea and Hyperbaric Medical Society; 1987.*
- Gorman D. Accidental arterial gas embolism. *Emerg Med (Fremantle).* 2002;14(4):364-70.
- Mitchell SJ. Lidocaine in the treatment of decompression illness: a review of the literature. *Undersea Hyperb Med.* 2001;28(3):165-74.
- Rubal BJ, Leon A, Meyers BL, Bell CM. The ‘mill-wheel’ murmur and computed tomography of intracardiac air emboli. *J Am Assoc Lab Anim Sci.* 2009;48(3):300-2.
- Tekle WG, Adkinson CD, Chaudhry SA, Jadhav V, Hassan AE, Rodriguez GJ, et al. Factors associated with favorable response to hyperbaric oxygen therapy among patients presenting with iatrogenic cerebral arterial gas embolism. *Neurocrit Care.* 2013;18(2):228-33.
- Brull SJ, Prielipp RC. Vascular air embolism: A silent hazard to patient safety. *J Crit Care.* 2017;42:255-63.
- Hodgson M, Beran RG, Shirtley G. The role of computed tomography in the assessment of neurologic sequelae of decompression sickness. *Arch Neurol.* 1988;45(9):1033-5.
- Newcomb A, Frawley G, Fock A, Bennett M, d’Udekem Y. Hyperbaric oxygenation in the management of cerebral arterial gas embolism during cavopulmonary connection surgery. *J Cardiothorac Vasc Anesth.* 2008;22(4):576-80.
- Butler BD, Laine GA, Leiman BC, Wartens D, Kurusz M, Sutton T, et al. Effect of the Trendelenburg position on the distribution of arterial air emboli in dogs. *Ann Thorac Surg.* 1988;45(2):198-202.
- McDermott JJ DA, Evans DE, Flynn ET. Treatment of experimental cerebral air embolism with lidocaine and hyperbaric oxygen. *Undersea Biomedical Research.* 1990;17(Nov):525-34.
- Dutka A. Air or gas embolism. In: Camporese E, Barker, AC, editor. *Hyperbaric Oxygen Therapy: A Critical Review.* Bethesda 1991. p. 1-10.
- Murphy BP, Harford FJ, Cramer FS. Cerebral air embolism resulting from invasive medical procedures. Treatment with hyperbaric oxygen. *Ann Surg.* 1985;201(2):242-5.
- Ziser A, Adir Y, Lavon H, Shupak A. Hyperbaric oxygen therapy for massive arterial air embolism during cardiac operations. *J Thorac Cardiovasc Surg.* 1999;117(4):818-21.
- Beevor H, Frawley G. Iatrogenic cerebral gas embolism: analysis of the presentation, management and outcomes of patients referred to The Alfred Hospital Hyperbaric Unit. *Diving Hyperb Med.* 2016;46(1):15-21.
- van Hulst RA, Drenthen J, Haitsma JJ, Lameris TW, Visser GH, Klein J, et al. Effects of hyperbaric treatment in cerebral air embolism on intracranial pressure, brain oxygenation, and brain glucose metabolism in the pig. *Crit Care Med.* 2005;33(4):841-6.

- Blanc P, Boussuges A, Henriette K, Sainty JM, Deleflie M. Iatrogenic cerebral air embolism: importance of an early hyperbaric oxygenation. *Intensive Care Med.* 2002;28(5):559-63.
- Mader JT, Hulet WH. Delayed hyperbaric treatment of cerebral air embolism: report of a case. *Arch Neurol.* 1979;36(8):504-5.
- Dexter F, Hindman BJ. Recommendations for hyperbaric oxygen therapy of cerebral air embolism based on a mathematical model of bubble absorption. *Anesth Analg.* 1997;84(6):1203-7.
- Armon C, Deschamps C, Adkinson C, Fealey RD, Orszulak TA. Hyperbaric treatment of cerebral air embolism sustained during an open-heart surgical procedure. *Mayo Clin Proc.* 1991;66(6):565-71.
- Bitterman H, Melamed Y. Delayed hyperbaric treatment of cerebral air embolism. *Isr J Med Sci.* 1993;29(1):22-6.
- Wherrett CG, Mehran RJ, Beaulieu MA. Cerebral arterial gas embolism following diagnostic bronchoscopy: delayed treatment with hyperbaric oxygen. *Can J Anaesth.* 2002;49(1):96-9.
- Pearson RR, Goad RF. Delayed cerebral edema complicating cerebral arterial gas embolism: case histories. *Undersea Biomed Res.* 1982;9(4):283-96.
- Karen Van Hoesen TSN. *Gas Embolism: Venous and Arterial Gas Embolism.* In: Thom SR NT, editor. *Physiology and Medicine of Hyperbaric Oxygen Therapy.* Philadelphia, PA: Saunders Elsevier; 2008.
- Moon RE. Hyperbaric treatment of air or gas embolism: current recommendations. *Undersea Hyperb Med.* 2019;46(5):673-83.
- Zamboni WA, Roth AC, Russell RC, Graham B, Suchy H, Kucan JO. Morphologic analysis of the microcirculation during reperfusion of ischemic skeletal muscle and the effect of hyperbaric oxygen. *Plast Reconstr Surg.* 1993;91(6):1110-23.
- Martin JD, Thom SR. Vascular leukocyte sequestration in decompression sickness and prophylactic hyperbaric oxygen therapy in rats. *Aviat Space Environ Med.* 2002;73(6):565-9.
- Mitchell SJ, Pellett O, Gorman DF. Cerebral protection by lidocaine during cardiac operations. *Ann Thorac Surg.* 1999;67(4):1117-24.
- Mitchell SJ, Merry AF, Frampton C, Davies E, Grieve D, Mills BP, et al. Cerebral protection by lidocaine during cardiac operations: a follow-up study. *Ann Thorac Surg.* 2009;87(3):820-5.

## The expanding role of SGLT-2 inhibitors in the treatment of heart failure

### Aaron Pym, MBBS (Hons) B Econ FANZCA

Fellow, The Canberra Hospital, ACT

Dr Aaron Pym is completing a Fellowship in Perioperative Medicine at the Canberra Hospital. His research interests include the outcomes of obese patients in clinical anaesthesia, and the prevention and management of early post-operative nausea and vomiting. Aaron is also an Early Management of Severe Trauma (EMST) course instructor.

### Ross Hanrahan, MBBS MMed PGCertCU FANZCA

Specialist Anaesthetist, The Canberra Hospital and Calvary Public Hospital, ACT

Dr Ross Hanrahan is a consultant anaesthetist with an interest in perioperative medicine focussing on perioperative risk reduction. Other interests include the use of ultrasound for point-of-care echocardiography and regional anaesthesia.

### Peter Flynn, BSciMed (Hons) MBBS (Hons) FANZCA

VMO Anaesthetist at The Canberra Hospital and Calvary Public Hospital, ACT

Dr Peter Flynn is a consultant anaesthetist and supervisor of anaesthetic training in Canberra. He has an interest in adult education and perioperative medicine across the Australian Capital Territory.

### Thomas Bruessel, Dr med, FANZCA

Director, Department of Anaesthesia, Perioperative Medicine and Pain Management, Canberra Health Service, ACT

Professor Thomas Bruessel is the director of the department and chair of anaesthesia at the Australian National University. He has a strong interest in regional anaesthesia, neuroanaesthesia and neuro medicine.

## INTRODUCTION

The role for Sodium-Glucose Transport Protein 2 (SGLT2) inhibitors is expanding to include new patient groups, including those without Type 2 diabetes mellitus (T2DM) (see Table 1).

**Table 1. Approved indications for SGLT2 inhibitors**

Agent	Australia/New Zealand	Other countries
Dapagliflozin (Forxiga)	<ul style="list-style-type: none"> <li>▪ Improve glycaemic control in T2DM (Aus, NZ).</li> <li>▪ Prevent hospitalisation for heart failure in those with T2DM and cardiovascular disease or risk factors (Aus, NZ).</li> <li>▪ Improve symptom control and cardiovascular outcomes as adjunct therapy in HFrEF (Aus).</li> <li>▪ Prevent new or worsening nephropathy in T2DM and cardiovascular disease or risk factors (NZ).</li> <li>▪ Treatment of chronic kidney disease in adults (NZ).</li> </ul>	<ul style="list-style-type: none"> <li>▪ Improve glycaemic control in T2DM (EU, US, UK).</li> <li>▪ Improve glycaemic control in T1DM as adjunct to insulin (Jap).</li> <li>▪ Improve glycaemic control in overweight patients with T1DM (BMI <math>\geq</math>27kg/m<sup>2</sup>) as adjunct to insulin (EU, UK).</li> <li>▪ Reduce risk of hospitalisation for heart failure in T2DM with cardiovascular disease or risk factors (US).</li> <li>▪ Reduce hospitalisation for HFrEF in adults (NYHA II-IV) (EU, US, UK).</li> <li>▪ Reduce the risk of declining renal function, kidney failure, cardiovascular death and hospitalisation for heart failure in adults with chronic kidney disease at risk of progression (US).</li> </ul>

Empagliflozin (Jardiance)	<ul style="list-style-type: none"> <li>Improve glycaemic control in T2DM (Aus, NZ).</li> <li>Prevent cardiovascular death in those with T2DM and established cardiovascular disease (Aus, NZ).</li> </ul>	<ul style="list-style-type: none"> <li>Improve glycaemic control in T2DM (EU, US, UK).</li> <li>Prevent cardiovascular death in those with T2DM and established cardiovascular disease (US).</li> <li>Prevent hospitalisation for HFrEF (US, under FDA review).</li> </ul>
Canagliflozin (Invokana)	<ul style="list-style-type: none"> <li>Withdrawn from marketing for commercial reasons (Aus, NZ).</li> </ul>	<ul style="list-style-type: none"> <li>Improve glycaemic control in T2DM (US, EU).</li> <li>Reduce the risk of major adverse cardiovascular events in T2DM with established cardiovascular disease (US).</li> <li>Reduce the progression of chronic kidney disease in T2DM and chronic kidney disease (EU, US).</li> </ul>
Ertugliflozin (Steglatro)	<ul style="list-style-type: none"> <li>Improve glycaemic control in T2DM (Aus).</li> </ul>	<ul style="list-style-type: none"> <li>Improve glycaemic control in T2DM (EU, US, UK).</li> </ul>
Sotagliflozin (Zynquista)	<ul style="list-style-type: none"> <li>Not currently approved for use.</li> </ul>	<ul style="list-style-type: none"> <li>Improve glycaemic control as adjunct to insulin in overweight patients (BMI <math>\geq 27\text{kg/m}^2</math>) with T1DM (EU).</li> </ul>

Aus, Australia. NZ, New Zealand. EU, European Union. US, United States. UK, United Kingdom. Jap, Japan. T2DM, Type 2 diabetes mellitus. T1DM, Type 1 diabetes mellitus. HFrEF, Heart failure with reduced ejection fraction.

The SGLT2 inhibitors have an established role in T2DM, improving HbA1c by 0.5-1 per cent<sup>1,2</sup>, and are known to also promote modest weight loss and blood pressure reductions<sup>3,4</sup>. Their use is already increasing in Australia. The Pharmaceutical Benefits Scheme observed a 24 per cent year-on-year increase in SGLT2 inhibitor use during the most recent 2019/20 financial year, subsidising more than two million prescriptions (15 per cent of all oral anti-hyperglycaemic prescriptions)<sup>5,6</sup>. However, the prevalence of these agents in the perioperative patient population may continue to grow due to emerging high-level evidence supporting novel indications. As has previously been reported in this publication, large cardiovascular outcome trials in patients with T2DM across a spectrum of cardiovascular disease have demonstrated benefits to cardiovascular survival, heart failure, renal protection and major adverse cardiovascular events<sup>7-11</sup>. More recently, the SGLT2 inhibitors have been shown to reduce the incidence of hospitalisation for heart failure and cardiovascular death in patients without diabetes<sup>12,13</sup>. Other studies have demonstrated renal protection in diabetic patients with and without chronic kidney disease (CKD)<sup>9,13</sup>. Both heart failure and CKD are common disorders in the surgical population and are associated with significant morbidity, mortality and health expenditure.

The approved indications for SGLT2 inhibitors are expanding in light of this evidence. In Australia and other countries, regulators have approved certain SGLT2 inhibitors for the management of heart failure with reduced ejection fraction in patients with and without T2DM<sup>14-17</sup>. In Europe, SGLT2 inhibitors have been approved as an adjunct to insulin for the management of overweight patients with Type 1 diabetes mellitus (T1DM)<sup>16,18</sup>. This review will explore the established and emerging applications for SGLT2 inhibitors beyond glycaemic control in T2DM. The potential perioperative risks from this drug class have been well documented and range from minor urinary tract infection (UTIs) to severe complications such as urosepsis, limb amputation and ketoacidosis<sup>11,19-22</sup>. While the importance of careful management of SGLT2 inhibitors during the perioperative period is increasingly recognised<sup>23</sup>, anaesthetists should be aware of the evidence supporting new indications for these agents. The use of SGLT2 inhibitors will probably become more common over the medium term and are already being used in Australia by patients without diabetes. The perioperative patient may be at greater risk of harm from complications (especially if undergoing emergency surgery or with poorly controlled diabetes) than that reported in large safety and efficacy trials.

## CLINICAL BENEFITS OF SGLT2 INHIBITORS

### Chronic heart failure and Type 2 diabetes mellitus

Recent studies analysing the impact of SGLT2 inhibitors in T2DM found potentially practice-changing reductions in hospitalisation for heart failure, cardiovascular death and major adverse cardiac events (see Table 2).

**Table 2. Summary of randomised controlled trials of SGLT2 inhibitors and cardiovascular outcomes**

Trial	Study drug	Inclusion criteria	Participants (%T2DM)	Primary outcome HR (95%CI)	HHF HR (95%CI)	CV death HR (95%CI)	CKD progression* HR (95%CI)
EMPA REG (2015)	Empagliflozin	T2DM & established CVD	7,020 (100%)	CV death, MI, Stroke: 0.86 (0.74–0.99)	0.65 (0.50–0.85)	0.62 (0.49–0.77)	N/R
CANVAS Program (2017)	Canagliflozin	T2DM & high CVD risk	10,142 (100%)	CV death, MI, Stroke: 0.86 (0.75–0.97)	0.67 (0.52–0.87)	0.87 (0.72–1.06)	0.60 (0.47–0.77)
DECLARE-TIMI (2019)	Dapagliflozin	T2DM & established CVD or risk factors	17,160 (100%)	CV death, MI, Stroke: 0.83 (0.73–0.95)	0.73 (0.61–0.88)	0.98 (0.82–1.17)	0.76 (0.67–0.87)
DAPA HF (2019)	Dapagliflozin	Chronic HF (NYHA II-IV) & LVEF $\leq 40\%$ with GDMT	4,744 (42%)	CV death or HHF: 0.74 (0.65–0.85)	0.70 (0.59–0.83)	0.82 (0.69–0.98)	0.53 (0.43–0.66)
EMPEROR Reduced (2020)	Empagliflozin	Chronic HF (NYHA II-IV) & LVEF $\leq 40\%$ with GDMT	3,730 (50%)	CV death or HHF: 0.75 (0.65–0.86)	0.70 (0.58–0.85)	0.92 (0.75–1.12)	0.50 (0.32–0.77)
SOLOIST WHF (2020)	Sotagliflozin	T2DM & recent acute HF admission	1,222 (100%)	CV death or HHF: 0.67 (0.52–0.85)	0.64 (0.49–0.83)	0.84 (0.58–1.22)	N/R**
EMPEROR preserved (2021)	Empagliflozin	Chronic HF (NYHA II-IV) with LVEF $>40\%$	5,988 (49%)	CV death or HHF: 0.79 (0.69–0.90)	0.71 (0.60–0.83)	0.91 (0.76–1.09)	N/R***

T2DM, Type 2 diabetes mellitus. HR, Hazard ratio. 95%CI, 95% confidence interval. HHF, Hospitalisation for heart failure. CV, Cardiovascular. CKD, Chronic kidney disease. CVD, Cardiovascular disease. MI, Myocardial infarction. HF, Heart failure. NYHA, New York Heart Association. LVEF, Left ventricular ejection fraction. GDMT, Guideline-directed medical therapy. N/R, not reported.

\*CKD progression generally described as a sustained decline in eGFR  $\geq 40\%$  to eGFR  $< 60\text{mL/min/m}^2$ , progression to renal replacement therapy or eGFR  $< 15\text{mL/min/m}^2$  or renal death; see individual trials for specific definitions.

\*\*HR for CKD progression not reported; eGFR data favoured placebo (mean change in eGFR -0.16 (-1.30 – 0.98)).

\*\*\*HR for CKD Not reported; eGFR data favoured empagliflozin (mean change in eGFR -1.37mL per year).

The size of effect, and the short latency to effect (within months) suggests a mechanism unrelated to glycaemic control, and potentially direct cardioprotective effects from this drug class. A meta-analysis of randomised controlled trials regarding the cardiovascular outcomes of SGLT2 inhibitors in T2DM included studies of empagliflozin, dapagliflozin and canagliflozin<sup>1</sup>. Overall, SGLT2 inhibitors were shown to reduce the risk of cardiovascular death or hospitalisation for heart failure by 23 per cent, with a similar benefit observed in those with and without heart failure, and with and without cardiovascular disease. The risk of major adverse cardiac events was reduced by 11 per cent but found benefit only in those with established cardiovascular disease and not in those without<sup>1</sup>.

The first major randomised controlled trial to demonstrate significant cardiovascular benefits was EMPA-REG OUTCOME<sup>7</sup>. This study included participants with T2DM and cardiovascular disease who were already optimised with standard-of-care medications for cardiovascular comorbidities. This was a high-risk cohort; the majority (99 per cent) of patients had prior cardiovascular events (stroke, myocardial infarction, amputation or coronary artery disease). Investigators demonstrated a 38 per cent relative risk reduction for cardiovascular death, 32 per cent for all-cause mortality, and 55 per cent for hospitalisation for heart failure<sup>7</sup>. Next, DECLARE-TIMI included participants with T2DM but relatively low cardiovascular risk and preserved renal function<sup>9</sup>. Investigators found a 17 per cent relative risk reduction in the composite of CV death and hospitalisation for heart failure, with similar benefits in patients with and without pre-existing atherosclerotic disease or heart failure. The CANVAS program included patients with T2DM (HbA1c  $\geq 7.5$  and  $\leq 10.5\%$ ) and either symptomatic

atherosclerotic disease or at least two defined cardiovascular risk factors<sup>24</sup>. Investigators found a 39 per cent relative risk reduction in hospitalisation for heart failure and a 20 per cent reduction for major cardiac events or cardiovascular death. Importantly, a subsequent analysis found canagliflozin reduced hospitalisation for heart failure and other cardiovascular events across all HbA1c sub-groups, even those with good glycaemic control (HbA1c 6.5-7.0%)<sup>25</sup>. Although canagliflozin has since been withdrawn from the Australian market for commercial reasons, these data support the potential for a class effect from SGLT2 inhibitors, and observed benefits even for those with well-controlled diabetes<sup>26</sup>. It is possible that the sponsor will seek to reintroduce canagliflozin to local markets given recent approvals in other countries for those with diabetic and non-diabetic chronic kidney disease (see Table 1).

#### Acute heart failure and Type 2 diabetes mellitus

In contrast to prior studies in T2DM, sotagliflozin has been studied in patients recovering from acute heart failure<sup>10</sup>. Sotagliflozin reduced the relative risk of hospitalisation for heart failure or CV death by 33 per cent when initiated in-hospital or within three days of discharge for an acute heart failure admission. Severe hypoglycaemia was more common in the sotagliflozin group, which may be related to its mechanism as a dual SGLT1/SGLT2 inhibitor<sup>10</sup>. This study has demonstrated a potential role for initiating sotagliflozin early in the recovery phase from an episode of acute heart failure in patients with T2DM, although the practical safety challenges must be resolved before regulatory approvals are likely for this indication.

#### Heart failure in non-diabetic patients

The impressive reductions in hospitalisation for heart failure and cardiovascular death have also been shown in non-diabetic patients (see Table 2). The DAPA-HF (dapagliflozin) study recruited 4744 patients with known heart failure with and without diabetes<sup>12</sup>. All participants had heart failure with reduced ejection fraction (LVEF  $\leq$ 40%) and NYHA Grade II-IV symptoms and were optimised on guideline-directed medical therapy prior to randomisation. Less than half of the participants had T2DM. Those with diabetes had their usual anti-hyperglycaemic therapy continued after addition of dapagliflozin (with dose-modification of their usual medications to prevent hypoglycaemia if necessary). Investigators demonstrated a 26 per cent relative risk reduction for worsening heart failure (hospitalisation or need for IV therapy) and an 18 per cent reduction for cardiovascular death. The number needed to treat to prevent one primary event was 21. The progression of heart failure symptoms was measured using a validated assessment tool; the dapagliflozin group were more likely to experience a clinical improvement, and less likely to experience a deterioration than the placebo group. The beneficial effects were similar across all subgroups including those without diabetes at baseline, and in those diabetic patients with good glycaemic control<sup>12,27</sup>.

A subsequent analysis examined sub-groups according to pre-existing heart failure therapy<sup>28</sup>. Investigators examined dose intensity of traditional heart failure therapies, the use of sacubitril/valsartan or ivabradine and the presence of cardiac resynchronisation therapy. Improvements in heart failure outcomes and cardiovascular mortality were consistently shown across treatment sub-groups, even in patients already optimised with existing treatments. Prior to these data, it had been unclear whether the diuretic benefit would still be induced in patients already using loop diuretics and mineralocorticoid receptor antagonists, or whether a significant volume contraction or worsening of CKD might develop. Among patients with heart failure with reduced ejection fraction, dapagliflozin lowers the risk of worsening heart failure or death from cardiovascular causes, and results in better symptom control and fewer exacerbations in those with and without diabetes.

Empagliflozin has also been investigated in heart failure patients with and without diabetes. The EMPEROR-Reduced trial<sup>13</sup> targeted patients with more significant LV dysfunction than DAPA-HF. Investigators recruited those with heart failure with reduced ejection fraction and either LVEF  $\leq$ 30% or LVEF  $\leq$ 40% with recent hospitalisation for heart failure or very high biomarkers. Approximately 50 per cent of patients had T2DM, and 73 per cent had LVEF  $\leq$ 30%. Empagliflozin was associated with a 25 per cent relative risk reduction for CV death or hospitalisation for heart failure; a number needed to treat of 19 to prevent one primary event. These findings were consistent across sub-groups, including patients with and without diabetes. Apart from higher rates of genital tract infections, there were no differences in hypoglycaemia or markers of heart failure safety (hypotension, volume depletion, renal dysfunction, bradycardia, dyselectrolytaemia).

EMPEROR preserved was a randomised controlled trial of empagliflozin which included adults with class II-IV chronic heart failure and an ejection fraction  $>$ 40%<sup>29</sup>. Empagliflozin reduced the risk of hospitalisation for heart failure or cardiovascular death (HR 0.79; 95% CI 0.69-0.90;  $P <$ 0.001) in patients with and without diabetes. The number needed to treat to prevent one primary event was 31. Sub-group analysis demonstrated benefits in patients with both preserved (EF  $\geq$ 50%) and mildly reduced ejection fraction (EF 41-49%). Although it is unclear whether those with a greater ejection fraction receive a decremental benefit, this is an important finding. Most heart failure therapies are ineffective or only weakly beneficial in those with higher ejection fractions. The addition of SGLT2 inhibitors as a new therapeutic modality would be a major win for clinicians treating heart failure with preserved ejection fraction. The DELIVER trial is examining dapagliflozin in adults with heart

failure and ejection fraction  $>$ 40%. If benefits are confirmed for this difficult-to-treat condition, we should expect to see even more patients using SGLT2 inhibitors in the future.

#### Type 1 diabetes mellitus

Insulin therapy alone does not always achieve adequate glycaemic control in patients with T1DM. Certain SGLT2 inhibitors have been investigated as adjuncts to achieve HbA1c targets in T1DM<sup>30-32</sup> and are approved for this use in the European Union, United Kingdom and Japan<sup>16-18,33</sup>. Studies in this patient group have found significant reductions in mean HbA1c, total daily insulin dose and body weight<sup>30-32,34</sup>. In placebo-controlled trials, dapagliflozin has been shown to significantly increase the proportion of patients achieving a reduction in HbA1c  $\geq$ 0.5% without an increase in severe hypoglycaemia. Similarly, almost twice as many participants using sotagliflozin achieved HbA1c  $<$ 7.0% without a severe adverse event<sup>30</sup>. Both drugs are associated with a greater rate of DKA in T1DM, although the incidence is lower in overweight patients (BMI  $\geq$ 27kg/m<sup>2</sup>)<sup>30,31,34,35</sup>. Most regulators which have approved SGLT2 inhibitors for T1DM have limited this adjunct therapy to the overweight population on safety grounds.

Diabetic ketoacidosis (DKA) is a significant problem for patients with T1DM and is responsible for up to 20 per cent of patient deaths<sup>36</sup>. The elevated risk in these patients using SGLT2 inhibitors remains a concern. Although approved for this use in the European Union, in the United States the Food and Drugs Administration (FDA) has so far declined approval for SGLT2 inhibitors in T1DM due to the higher rate of DKA<sup>37</sup>. The position of regulators in Australia and New Zealand has not yet been tested. Patients who use dapagliflozin or sotagliflozin as adjunct therapy in T1DM should receive a structured education program by trained educators, and be taught to recognise the risks, signs and symptoms of DKA and how to manage both "sick days" and elevated ketones<sup>38</sup>. Although this drug class has not yet been approved for use in T1DM in Australia or New Zealand, anaesthetists and perioperative practitioners should be aware of the potential for off-label use or use by international visitors.

#### Chronic kidney disease

Chronic kidney disease is one of the fastest-growing global causes of death, most commonly caused by diabetes, hypertension, ageing and obesity. In this context, agents which simultaneously improve control of blood sugar, blood pressure and body weight would be welcomed by nephrologists and other specialists<sup>39</sup>. The SGLT2 inhibitors provide all of these benefits and have demonstrated reno-protective effects in patients with and without diabetes, and in diabetic patients with and without CKD. Multiple studies have described renal outcomes from SGLT2 inhibitors in T2DM<sup>8,9,13,24,40-42</sup>. A meta-analysis of four studies (38,723 participants) found that the SGLT2 inhibitors substantially reduce the risk of dialysis, transplantation or death due to kidney disease by 33 per cent in T2DM (Relative risk, RR 0.67, 95%CI 0.52-0.86)<sup>41</sup>. SGLT2 inhibitors also reduced progression to end-stage kidney disease (ESKD) (RR 0.65, 95%CI 0.53-0.81) and acute kidney injury (RR 0.75, 95%CI 0.66-0.85). These effects were consistent across all studies. This meta-analysis demonstrated that benefits were also consistent across all subgroups of baseline renal function, those with and without albuminuria, and those already using renin-angiotensin-aldosterone system antagonists<sup>41,43</sup>.

Renal protection with dapagliflozin has also been demonstrated in non-diabetic kidney disease. The DAPA-CKD trial included participants with CKD (mean baseline eGFR 43mL/min/1.73m<sup>2</sup>) and followed patients for a mean of 2.4 years before stopping early due to efficacy<sup>44</sup>. Dapagliflozin reduced the risk of a  $>$ 50% eGFR decline, ESKD, or renal or CV death by 39 per cent (Hazard ratio, HR=0.61, 95%CI 0.51-0.72). The number needed to treat to avoid one primary endpoint was 19. The benefit was similar in patients with and without diabetes and was independent of pre-existing renal function. Dapagliflozin appears safe in non-diabetic kidney disease, with no increase in hypoglycaemia or ketoacidosis identified, although the participant numbers were relatively low and may not have been powered to find uncommon outcomes. Similar data have been presented for canagliflozin, although this is no longer available in Australia<sup>40</sup>.

Regulators in the United States and the European Union have authorised canagliflozin for use in secondary prevention of CKD in diabetic kidney disease, and in the United States dapagliflozin is approved for renal protection in non-diabetic CKD. The renal outcomes for diabetic and non-diabetic patients are impressive. Drug sponsors may seek to expand approved indications for SGLT2 inhibitors to include renal protection in diabetes or established non-diabetic kidney disease. In the meantime, we may also see nephrologists and other physicians prescribing SGLT2 inhibitors off-label for use in CKD.

## PROPOSED MECHANISMS OF BENEFIT IN HEART FAILURE

Large randomised controlled trials have demonstrated reductions in hospitalisation for heart failure with SGLT2 inhibitors within just months of initiating therapy. The size and speed of this effect, consistent efficacy in people with satisfactory glycaemic control (T2DM with HbA1c  $<$ 6.5% and non-diabetics) and lack of benefit in atherosclerotic complications suggest a mechanism unrelated to anti-hyperglycaemic effects. The beneficial

effect appears consistent for those with heart failure already optimised on conventional guideline-directed medical therapy, which also suggests a mechanism independent of the traditional neurohormonal pathways of heart failure treatment. There is some pre-clinical and clinical research into the potential protective mechanisms in heart failure.

#### Preload reduction and novel diuretic mechanisms

In heart failure, the activation of the renin-angiotensin-aldosterone system and sympathetic nervous system lead to salt and fluid retention and a progressively fluid-overloaded state<sup>45</sup>. Eventually an unfavourable myocyte length-tension relationship develops, with worsening myocardial performance and intravascular and interstitial sodium and fluid retention<sup>45</sup>. In a post-hoc mediation analysis of one large trial, investigators established that approximately 50 per cent of the benefit in cardiovascular death reduction was attributed to haemoconcentration and diuresis<sup>46,47</sup>, which would reduce preload and ventricular filling pressures.

The SGLT2 inhibitors have several unique diuretic attributes. First, they act at the renal proximal convoluted tubule to prevent glucose reabsorption and induce a natriuresis and osmotic diuresis without impacting plasma osmolality<sup>48</sup>. Sodium and glucose excretion has been observed to increase to 170 per cent and 2700 per cent of baseline respectively<sup>49-52</sup>. The osmotic effect creates tubular fluid with a lower concentration of sodium and chloride, and so these are not reabsorbed at the loop of Henle as might be expected; this natriuresis has been shown to reduce total body sodium<sup>46</sup>. Second, this mechanism induces tubuloglomerular feedback through increased delivery of fluid and sodium to the macula densa which stimulates afferent tubule vasoconstriction and reduces glomerular hypertension<sup>52,53</sup>. In contrast, traditional thiazide and loop diuretics inhibit sodium entry to the macula densa and promote efferent arteriole vasoconstriction. This may be the mechanism of the reno-protective benefits observed in trials and may also explain the observed increase in erythropoietin secretion<sup>53</sup>. Third, the SGLT2 inhibitors appear to selectively reduce interstitial fluid clearance to relieve organ congestion without reducing intravascular volume. This may explain the absence of reflex neurohormonal activation; traditional diuretics are observed to induce off-target electrolyte-wasting and renin-angiotensin-aldosterone system activation with counter-productive vasoconstriction and sodium retention<sup>48,49,54-57</sup>. This diuresis is synergistic with loop diuretics<sup>49</sup>, and may be valuable in those resistant to loop diuretics<sup>58</sup>.

#### Afterload reduction

Increased afterload is indicative of increased myocardial oxygen demand and includes arteriolar resistance and the pulsatile load generated by arterial stiffness. Investigators measuring surrogates for arterial stiffness and resistance (ambulatory arterial stiffness index, pulse pressure and central systolic blood pressure) found favourable reductions in patients using empagliflozin<sup>59,60</sup>. Modest reductions in systolic and mean blood pressure (4-10mmHg and 2mmHg, respectively) have been observed with SGLT2 inhibitor use<sup>3,59</sup>. Similar improvements to arterial resistance and vascular function have been demonstrated in a pilot study with dapagliflozin, suggesting a class effect<sup>61</sup>. Afterload reduction will reduce cardiac work and can be expected to improve left ventricular function<sup>56</sup>. This effect is only partly explained by a diuresis; although the volume loss is persistent over time (unlike with thiazide diuretics)<sup>51,52</sup>, the reductions in blood pressure do not correlate with measured fluid losses<sup>62</sup>.

#### Myocardial energy metabolism

Progressive heart failure induces unfavourable metabolic pathways, resulting in increased free fatty acid intermediates which further impair myocardial function<sup>47,52</sup>. The SGLT2 inhibitors increase circulating ketones in patients with and without T2DM<sup>52,63</sup>, probably due to glucagon-mediated ketogenesis or decreased renal ketone excretion<sup>47</sup>. Ketones are freely taken up by the heart and offer an additional and potentially more efficient myocardial energy supply for the failing heart<sup>52,56,64,65</sup>. This substrate improves transduction of oxygen consumption into work efficiency, and would be synergistic with the increased oxygen delivery associated with haemoconcentration<sup>64</sup>. These metabolic changes may partially explain increased cardiac output in heart failure but does not well explain the benefits observed in those without known heart failure. At present this is hypothesis-generating; there are no data definitively linking myocardial energetics to improvements in heart failure outcomes<sup>47</sup>.

#### Sodium-hydrogen transport protein inhibition

The SGLT2 inhibitors appear to inhibit Na/H exchange (NHE) proteins, leading to increased myocardial calcium availability. This has been associated with beneficial cardiac remodelling, with reductions in cardiac hypertrophy, fibrosis and systolic dysfunction<sup>66,67</sup>. Empagliflozin has been observed to functionally inhibit a myocardial isoform NHE1<sup>66,67</sup>, which reduces cytosolic sodium and calcium, and increases mitochondrial calcium and ATP activation in experimental models<sup>47,48</sup>. As SGLT2 proteins are not present in cardiac tissue, the mechanism for this interaction is unclear. However, NHE3 proteins do exist in the kidneys where they reabsorb tubular sodium after filtration<sup>47</sup>. An interaction between myocardial NHE1 and renal NHE3 would be biologically plausible and potentially represent a common mechanism of cardiorenal protection. Although NHE protein inhibition has been observed with SGLT2 inhibitors, the mechanism and relevance to myocardial performance is currently hypothetical.

#### Myocardial remodelling

Modest beneficial changes in myocardial mass and volume have been noted following the introduction of a SGLT2 inhibitor. Clinical studies have shown modest reductions in left ventricle end-systolic and end-diastolic volume indices after 12-36 weeks in patients with heart failure with reduced ejection fraction<sup>56,68-70</sup>. Other studies have shown modest but significant reductions in left ventricular mass by -3.35 to -9.0g/m<sup>2</sup> body surface area<sup>68,69,71</sup>. This demonstrates a favourable impact on ventricular remodelling, as larger volumes are associated with worse non-fatal and mortality outcomes. The beneficial changes have been observed in those on optimal medical therapy. The magnitude of change is similar to other beneficial therapies in heart failure, and was incremental to those gains<sup>70</sup>.

The SGLT2 inhibitors have been shown to reduce cardiac fibrosis in animal and human models. In animal models of myocardial infarction, investigators have demonstrated reduced myofibroblast infiltration, improved cardiac metabolism and greater cardiac ATP production in patients exposed to SGLT2 inhibitors compared to controls<sup>72,73</sup>. Similar results have been shown in human atrial tissue, with a more quiescent phenotype of myofibroblast in tissue exposed to empagliflozin<sup>74</sup>. These changes are consistent with the benefits observed in large clinical studies and may explain improvements in diastolic function and ventricular mass.

### CONCLUSION

In Australia and other countries, SGLT2 inhibitors are approved for treatment of heart failure as well as to improve glycaemic control in T2DM. Other jurisdictions have already approved their use in T1DM, and it is possible that approved indications may expand to include secondary prevention in non-diabetic chronic kidney disease. Even among patients with T2DM and good glycaemic control, the data appear to justify addition of SGLT2 inhibitors to prevent heart failure and progression of renal disease. There appears to be sufficient data to justify interest in SGLT2 inhibitors from cardiologists, nephrologists and endocrinologists, and the use of these agents may continue to increase.

Perioperative practitioners may soon find an even more diverse group of patients using these agents. Anaesthetists and perioperative physicians in Australia and New Zealand should be aware of these expanding indications and be vigilant for new approvals in our jurisdictions.

The perioperative risks from this drug class range from relatively mild to severe or life-threatening. Genital tract infections are common and usually mild<sup>20</sup> but can be severe and may theoretically increase the risk of prosthetic implant infections<sup>21</sup>. Genital hygiene advice should be reiterated to any patient planning an at-risk procedure. Surgeons and perioperative physicians should consider routine UTI screening with history and urine dipstick testing for patients at particularly high risk of complications (for example, joint replacement or cardiac surgery), and the need for urinary catheterisation carefully considered.

“Euglycaemic” DKA is a life threatening complication presenting with normal or near-normal serum glucose<sup>22</sup>. Although rare in large safety studies, euglycaemic DKA may be more common in the perioperative patient especially if undergoing emergency surgery or in the setting of acute illness, reduced oral intake or underlying poor glycaemic control. All patients using SGLT2 inhibitors should be educated about the risk of euglycaemic DKA and should be taught to develop a “sick-day” medication management plan to withhold the drugs while unwell. Although the incidence of euglycaemic DKA was low and similar to placebo for non-diabetic patients using SGLT2 inhibitors in large phase III trials, it is unclear whether these data apply to the perioperative patient group who may be at greater risk of relative insulin deficiency if fasting or undergoing physiological stress. For now, anaesthetists and perioperative physicians should be aware that patients with all forms of diabetes are at similar risk of this complication. While regulators and industry bodies (including ANZCA and the Australian Diabetes Society) have already advocated careful management during the perioperative phase, evidence and expert opinion continues to emerge and advice is frequently updated. Local and FDA advice is to cease most SGLT2 inhibitors three days prior to non-day surgery or bowel preparation for colonoscopy (day of surgery and two days prior). However, a recent British consensus statement recommends withholding only for two days (day of surgery and one day prior), except in patients requiring prolonged fasting such as for bowel preparation<sup>23,75,76</sup>. In all cases, SGLT2 inhibitors should not be restarted until the resumption of normal oral intake and resolution of acute illness.

### ACKNOWLEDGEMENT

The authors would like to acknowledge the kind contribution by Professor Walter Abhayaratna OAM in reviewing this manuscript.

## REFERENCES

- Zelniker TA, Wiviott SD, Raz I, Im K, Goodrich EL, Bonaca MP, et al. SGLT2 Inhibitors for primary and secondary prevention of cardiovascular and renal outcomes in Type 2 diabetes: a systematic review and meta-analysis of cardiovascular outcome trials. *Lancet*. 2019 Jan;393(10166):31-9.
- Scheen AJ. Reduction in HbA1c with SGLT2 inhibitors vs. DPP-4 inhibitors as add-ons to metformin monotherapy according to baseline HbA1c: A systematic review of randomized controlled trials. *Diabetes Metab*. 2020 Jun;46(3):186-96.
- Oliva RV, Bakris GL. Blood pressure effects of sodium–glucose co-transport 2 (SGLT2) inhibitors. *J Am Soc Hypertens*. 2014 May;8(5):330-9.
- Hu M, Cai X, Yang W, Zhang S, Nie L, Ji L. Effect of hemoglobin A1c reduction or weight reduction on blood pressure in Glucagon-Like Peptide-1 Receptor agonist and sodium-glucose cotransporter-2 inhibitor treatment in Type 2 diabetes mellitus: A Meta-analysis. *J Am Heart Assoc*. 2020 Apr;9(7):e015323.
- Australian Government Department of Health. PBS Expenditure and Prescriptions Report 1 July 2019 to 30 June 2020. [Internet]. Canberra (ACT): Australian Government Department of Health; 2020 Dec 17 [Cited 2021 May 28]. Available from: <https://www.pbs.gov.au/info/statistics/expenditure-prescriptions/pb-expenditure-and-prescriptions-report-1-july-2019>.
- Australian Government Department of Health. Pharmaceutical Benefits Scheme and Repatriation Pharmaceutical Benefits Scheme Section 85 Supply Data. [Internet]. Canberra (ACT): Australian Government Department of Health; 2021 May 14 [Cited 2021 May 27]. Available from: <https://www.pbs.gov.au/info/statistics/dos-and-dop/dos-and-dop>.
- Zinman B, Wanner C, Lachin JM, Fitchett D, Bluhmki E, Hantel S, et al. Empagliflozin, cardiovascular outcomes, and mortality in Type 2 diabetes. *N Engl J Med*. 2015 Nov;373(22):2117-28.
- Perkovic V, Jardine MJ, Neal B, Bompoint S, Heerspink HJ, Charytan DM, et al. Canagliflozin and renal outcomes in Type 2 diabetes and nephropathy. *N Engl J Med*. 2019 Jun;380(24):2295-306.
- Wiviott SD, Raz I, Bonaca MP, Mosenzon O, Kato ET, Cahn A, et al. Dapagliflozin and cardiovascular outcomes in Type 2 diabetes. *N Engl J Med*. 2018 Jan;380(4):347-57.
- Bhatt DL, Szarek M, Steg PG, Cannon CP, Leiter LA, McGuire DK, et al. Sotagliflozin in patients with diabetes and recent worsening heart failure. *N Engl J Med*. 2020 Jan;384(2):117-28.
- Thiruvenkatarajan V, Meyer EJ, Nanjappa, N; Currie, J; Van Wijk, RM; Jesudason, D. Euglycaemic diabetic ketoacidosis associated with sodium-glucose cotransporter-2 inhibitors: New drugs bring new problems. In: Riley R, editor. *Australian Anaesthesia 2019*. Melbourne (Vic): Australian and New Zealand College of Anaesthetists; 2019. p. 251-64.
- McMurray JJ, Solomon SD, Inzucchi SE, Køber L, Kosiborod MN, Martinez FA, et al. Dapagliflozin in patients with heart failure and reduced ejection fraction. *N Engl J Med*. 2019 Nov;381(21):1995-2008.
- Packer M, Anker SD, Butler J, Filippatos G, Pocock SJ, Carson P, et al. Cardiovascular and renal outcomes with empagliflozin in heart failure. *N Engl J Med*. 2020 Oct;383(15):1413-24.
- Food and Drugs Administration. FDA approves new treatment for a type of heart failure. [Internet]. Silver Springs (MD): Food and Drugs Administration; 2020 May [cited 2021 May 28]. Available from: <https://www.fda.gov/news-events/press-announcements/fda-approves-new-treatment-type-heart-failure>
- AstraZeneca Pty Ltd. Forxiga (Dapagliflozin) Consumer Medicine Information. [Internet]. Sydney (NSW): AstraZeneca Pty Ltd; 2020 Oct [cited 2021 May 28]. Available from: <http://www.guildlink.com.au/gc/ws/astra/cmi.cfm?product=apcforxi11120>
- European Medicines Agency. Forxiga (Dapagliflozin): An overview of Forxiga and why it is authorised in the EU (Summary of Product Characteristics). [Internet]. Amsterdam (NL): European Medicines Agency; 2020 [cited 2021 May 28]. Available from: [https://www.ema.europa.eu/en/documents/overview/forxiga-epar-medicine-overview\\_en.pdf](https://www.ema.europa.eu/en/documents/overview/forxiga-epar-medicine-overview_en.pdf)
- AstraZeneca UK Limited. Forxiga 10mg film-coated tablets (Summary of Product Characteristics). [Internet]. Luton (UK): AstraZeneca UK Limited; 2021 [cited 2021 May 28]. Available from: <https://www.medicines.org.uk/emc/product/7607/smpc#gref>
- European Medicines Agency. Zynquista (Sotagliflozin): An overview of Zynquista and why it is authorised in the EU (summary of product characteristics)[Internet]. Amsterdam (NL): European Medicines Agency; 2019 [cited 2021 May 28]. Available from: [https://www.ema.europa.eu/en/documents/overview/zynquista-epar-medicine-overview\\_en.pdf](https://www.ema.europa.eu/en/documents/overview/zynquista-epar-medicine-overview_en.pdf)
- Chesterman T, Thynne TR. Harms and benefits of sodium-glucose co-transporter 2 inhibitors. *Aust Prescr*. 2020 Oct;43:168-71.
- Li D, Wang T, Shen S, Fang Z, Dong Y, Tang H. Urinary tract and genital infections in patients with type 2 diabetes treated with sodium-glucose co-transporter 2 inhibitors: A meta-analysis of randomized controlled trials. *Diabetes Obes Metab*. 2017 Mar;19(3):348-55.
- Bersoff-Matcha SJ, Chamberlain C, Cao C, Kortepeter C, Chong W. Fournier gangrene associated with sodium–glucose cotransporter-2 Inhibitors. *Ann Intern Med*. 2019 Jun;170(11):764-9.
- Goldenberg RM, Berard LD, Cheng AY, Gilbert JD, Verma S, Woo VC, et al. SGLT2 Inhibitor–associated diabetic ketoacidosis: Clinical review and recommendations for prevention and diagnosis. *Clin Ther*. 2016 Dec;38(12):2654-64.e1.
- Australian Diabetes Society. Alert update: Peri-procedural diabetic ketoacidosis (DKA) with SGLT2 inhibitor use. [Internet]. Sydney (NSW): Australian Diabetes Society; 2020 [cited 2021 May 28]. Available from: [https://diabetessociety.com.au/documents/ADS\\_DKA\\_SGLT2i\\_Alert\\_update\\_2020.pdf](https://diabetessociety.com.au/documents/ADS_DKA_SGLT2i_Alert_update_2020.pdf)
- Neal B, Perkovic V, Mahaffey KW, de Zeeuw D, Fulcher G, Erondou N, et al. Canagliflozin and cardiovascular and renal events in Type 2 diabetes. *N Engl J Med*. 2017 Aug;377(7):644-57.
- Cannon CP, Perkovic V, Agarwal R, Baldassarre J, Bakris G, Charytan DM, et al. Evaluating the effects of canagliflozin on cardiovascular and renal events in patients with Type 2 diabetes mellitus and chronic kidney disease according to baseline HbA1c, including those with HbA1c < 7%. *Circulation*. 2020 Feb;141(5):407-10.
- Janssen Cilag Pty Ltd. Invokana (canagliflozin): Removal from the Pharmaceutical Benefits Scheme. [Internet]. Sydney (NSW): Janssen Cilag Pty Ltd; 2015 [Cited 2021 May 28]. Available from: <https://www.endocrinesociety.org.au/documents/INVOKANADHCPLFeb16removalPBS.pdf>
- Petrie MC, Verma S, Docherty KF, Inzucchi SE, Anand I, Bělohávek J, et al. Effect of dapagliflozin on worsening heart failure and cardiovascular death in patients with heart failure with and without diabetes. *JAMA*. 2020 Apr;323(14):1353-68.
- Docherty KF, Jhund S, Inzucchi SE, Køber L, Kosiborod MN, Martinez FA, et al. Effects of dapagliflozin in DAPA-HF according to background heart failure therapy. *Eur Heart J*. 2020 Jul;41(25):2379-92.
- Anker SD, Butler J, Filippatos G, Ferreira JP, Bocchi E, Bohm M et al. Empagliflozin in heart failure with preserved ejection fraction. *New Engl J Med*. 2021 Aug. DOI: 10.1056/NEJMoa210703
- Garg SK, Henry RR, Banks P, Buse JB, Davies MJ, Fulcher GR, et al. Effects of sotagliflozin added to insulin in patients with Type 1 diabetes. *N Engl J Med*. 2017 Dec;377(24):2337-48.
- Dandona P, Mathieu C, Phillip M, Hansen L, Griffen SC, Tschöpe D, et al. Efficacy and safety of dapagliflozin in patients with inadequately controlled Type 1 diabetes (DEPICT-1): 24 week results from a multicentre, double-blind, phase 3, randomised controlled trial. *Lancet Diabetes Endocrinol*. 2017 Nov;5(11):864-76.
- Mathieu C, Dandona P, Gillard P, Senior P, Hasslacher C, Araki E, et al. Efficacy and safety of dapagliflozin in patients with inadequately controlled Type 1 Diabetes (the DEPICT-2 Study): 24-Week results from a randomized controlled trial. *Diabetes Care*. 2018 Sep;41(9):1938-46.
- Astellas Pharma, Inc. Approval of Suglat tablets, selective SGLT2 Inhibitor, for additional indication of Type 1 diabetes mellitus and additional dosage and administration in Japan. [Internet]. Tokyo (Japan): Astellas Pharma, Inc; 2018 [cited 2021 May 28]. Available from: <https://www.astellas.com/en/news/14481>
- Dandona P, Mathieu C, Phillip M, Hansen L, Thoren FA, Scheerer MF, et al. 1231-P: Dapagliflozin (DAPA) in Type 1 Diabetes (T1D): Pooled Outcomes from DEPICT-1 and -2. In: 79<sup>th</sup> Annual American Diabetes Association Scientific Sessions. 2019 Jun 7-11; San Francisco, CA. *Diabetes*. 2019 Jun;68(Supplement 1):1231-P.
- Paik J, Blair HA. Dapagliflozin: A review in Type 1 diabetes. *Drugs*. 2019 Nov;79(17):1877-84.
- O'Reilly JE, Blackburn LA, Caparrotta TM, Jeyam A, Kennon B, Leese GP, et al. Time trends in deaths before age 50 years in people with Type 1 diabetes: a nationwide analysis from Scotland 2004-2017. *Diabetologia*. 2020 Aug;63(8):1626-36.
- Wolfsdorf JI, Ratner RE. SGLT inhibitors for Type 1 Diabetes: Proceed with extreme caution. *Diabetes Care*. 2019 Jun;42(6):991-3.
- Ting S, Dent, R, Powell, J. Dapagliflozin with insulin for treating type 1 diabetes 2019. [Internet]. London (United Kingdom): National Institute for Health and Care Excellence; 2020. [cited 2021 May 28]. Available from: <https://www.nice.org.uk/guidance/ta597/chapter/1-Recommendations>
- Fernandez-Fernandez B, Sarafidis P, Kanbay M, Navarro-González JF, Soler MJ, Górriz JL, et al. SGLT2 inhibitors for non-diabetic kidney disease: drugs to treat CKD that also improve glycaemia. *Clin Kidney J*. 2020 Oct;13(5):728-33.
- Perkovic V, de Zeeuw D, Mahaffey KW, Fulcher G, Erondou N, Shaw W, et al. Canagliflozin and renal outcomes in Type 2 diabetes: results from the CANVAS Program randomised clinical trials. *Lancet Diabetes Endocrinol*. 2018 Sep;6(9):691-704.
- Neuen BL, Young T, Heerspink HJ, Neal B, Perkovic V, Billot L, et al. SGLT2 inhibitors for the prevention of kidney failure in patients with Type 2 diabetes: a systematic review and meta-analysis. *Lancet Diabetes Endocrinol*. 2019 Sep;7(11):845-54.
- Zannad F, Ferreira JP, Pocock SJ, Anker SD, Butler J, Filippatos G, et al. SGLT2 inhibitors in patients with heart failure with reduced ejection fraction: a meta-analysis of the EMPEROR-Reduced and DAPA-HF trials. *Lancet*. 2020 Sep;396(10254):819-29.
- Neuen BL, Ohkuma T, Neal B, Matthews DR, de Zeeuw D, Mahaffey KW, et al. Cardiovascular and renal outcomes With canagliflozin according to baseline kidney function. *Circulation*. 2018 Oct;138(15):1537-50.
- Heerspink HJ, Stefánsson BV, Correa-Rotter R, Chertow GM, Greene T, Hou F, et al. Dapagliflozin in patients with chronic kidney disease. *N Engl J Med*. 2020 Oct;383(15):1436-46.
- Kemp CD, Conte JV. The pathophysiology of heart failure. *Cardiovasc Pathol*. 2012 Sep-Oct;21(5):365-71.
- Inzucchi SE, Zinman B, Fitchett D, Wanner C, Ferrannini E, Schumacher M, et al. How does empagliflozin reduce cardiovascular mortality? Insights from a mediation analysis of the EMPA-REG OUTCOME trial. *Diabetes Care*. 2018 Feb;41(2):356-63.
- Verma S, McMurray JJ. SGLT2 inhibitors and mechanisms of cardiovascular benefit: a state-of-the-art review. *Diabetologia*. 2018 Oct;61(10):2108-17.
- Hwang I, Cho G, Yoon YE, Park JJ, Park J, Lee S, et al. Different effects of SGLT2 inhibitors according to the presence and types of heart failure in type 2 diabetic patients. *Cardiovasc Diabetol*. 2020 May;19(1):69.
- Griffin M, Rao VS, Ivey-Miranda J, Fleming J, Mahoney D, Maulion C, et al. Empagliflozin in heart failure: Diuretic and cardiorenal effects. *Circulation*. 2020 Sep;142(11):1028-39.
- Verma S, McMurray JJ, Cherney DZ. The Metabolodiuretic promise of sodium-dependent glucose cotransporter 2 inhibition: The search for the sweet spot in heart failure. *JAMA Cardiol*. 2017 Sep;2(9):939-40.
- Zanchi A, Burnier M, Muller ME, Ghajarzadeh-Wurzner A, Maillard M, Loncle N, et al. Acute and chronic effects of SGLT2 inhibitor empagliflozin on renal oxygenation and blood pressure control in nondiabetic normotensive subjects: A randomized, placebo-controlled trial. *J Am Heart Assoc*. 2020 Jul;9(13):e016173.
- Lopaschuk GD, Verma S. Mechanisms of cardiovascular benefits of sodium glucose co-transporter 2 (SGLT2) inhibitors: A state of the art review. *JACC Basic Transl Sci*. 2020 Jun;5(6):632-44.
- Heerspink HJ, Perkins BA, Fitchett DH, Husain M, Cherney DZ. Sodium glucose cotransporter 2 inhibitors in the treatment of diabetes mellitus. *Circulation*. 2016 Sep;134(10):752-72.
- Karg MV, Bosch A, Kannenkeril D, Striepe K, Ott C, Schneider MP, et al. SGLT-2-inhibition with dapagliflozin reduces tissue sodium content: a randomised controlled trial. *Cardiovasc Diabetol*. 2018 Jan;17(1):5.

55. Hallow KM, Helmlinger G, Greasley PJ, McMurray JJ, Boulton DW. Why do SGLT2 inhibitors reduce heart failure hospitalization? A differential volume regulation hypothesis. *Diabetes Obes Metab.* 2018 Mar;20(3):479-87.
56. Lan NS, Fegan PG, Yeap BB, Dwivedi G. The effects of sodium-glucose cotransporter 2 inhibitors on left ventricular function: current evidence and future directions. *ESC Heart Fail.* 2019 Oct;6(5):927-35.
57. Scheen AJ. Effect of SGLT2 inhibitors on the sympathetic nervous system and blood pressure. *Curr Cardiol Rep.* 2019 Jun;21(8):70.
58. Griffin M, Riello R, Rao VS, Ivey-Miranda J, Fleming J, Maulion C, et al. Sodium glucose cotransporter 2 inhibitors as diuretic adjuvants in acute decompensated heart failure: a case series. *ESC Heart Fail.* 2020 Aug;7(4):1966-71.
59. Chilton R, Tikkanen I, Cannon CP, Crowe S, Woerle HJ, Broedl UC, et al. Effects of empagliflozin on blood pressure and markers of arterial stiffness and vascular resistance in patients with type 2 diabetes. *Diabetes Obes Metab.* 2015 Dec;17(12):1180-93.
60. Cherney DZ, Perkins BA, Soleymanlou N, Har R, Fagan N, Johansen OE, et al. The effect of empagliflozin on arterial stiffness and heart rate variability in subjects with uncomplicated Type 1 diabetes mellitus. *Cardiovasc Diabetol.* 2014 Jan;13:28.
61. Solini A, Giannini L, Seghieri M, Vitolo E, Taddei S, Ghiadoni L, et al. Dapagliflozin acutely improves endothelial dysfunction, reduces aortic stiffness and renal resistive index in Type 2 diabetic patients: a pilot study. *Cardiovasc Diabetol.* 2017 Oct;16(1):138.
62. Baker WL, Smyth LR, Riche DM, Bourret EM, Chamberlin KW, White WB. Effects of sodium-glucose co-transporter 2 inhibitors on blood pressure: A systematic review and meta-analysis. *J Am Soc Hypertens.* 2014 Apr;8(4):262-75.e9.
63. Ferrannini E, Baldi S, Frascerra S, Astiarraga B, Heise T, Bizzotto R, et al. Shift to fatty substrate utilization in response to sodium-glucose cotransporter 2 inhibition in subjects without diabetes and patients with Type 2 Diabetes. *Diabetes.* 2016 May;65(5):1190-5.
64. Ferrannini E, Mark M, Mayoux E. CV Protection in the EMPA-REG OUTCOME Trial: A “Thrifty Substrate” Hypothesis. *Diabetes Care.* 2016 Jul;39(7):1108-14.
65. Verma S, Rawat S, Ho KL, Wagg CS, Zhang L, Teoh H, et al. Empagliflozin increases cardiac energy production in diabetes: Novel translational insights into the heart failure benefits of SGLT2 Inhibitors. *JACC Basic Transl Sci.* 2018 Aug;3(5):575-87.
66. Baartscheer A, Hardziyenka M, Schumacher CA, Belterman CN, van Borren MM, Verkerk AO, et al. Chronic inhibition of the Na<sup>+</sup>/H<sup>+</sup> - exchanger causes regression of hypertrophy, heart failure, and ionic and electrophysiological remodelling. *Br J Pharmacol.* 2008 Jul;154(6):1266-75.
67. Packer M, Anker SD, Butler J, Filippatos G, Zannad F. Effects of sodium-glucose cotransporter 2 inhibitors for the treatment of patients with heart failure: Proposal of a novel mechanism of action. *JAMA Cardiol.* 2017 Sep;2(9):1025-9.
68. Omar M, Jensen J, Ali M, Frederiksen PH, Kistorp C, Videbæk L, et al. Associations of empagliflozin with left ventricular volumes, mass, and function in patients with heart failure and reduced ejection fraction: A substudy of the Empire HF randomized clinical trial. *JAMA Cardiol.* 2021 Jan;e206827.
69. Verma S, Garg A, Yan AT, Gupta AK, Al-Omran M, Sabongui A, et al. Effect of empagliflozin on left ventricular mass and diastolic function in individuals with diabetes: An important clue to the EMPA-REG OUTCOME Trial? *Diabetes Care.* 2016 Dec;39(12):e212-e3.
70. Lee MM, Brooksbank KJ, Wetherall K, Mangion K, Roditi G, Campbell RT, et al. Effect of empagliflozin on left ventricular volumes in patients with Type 2 Diabetes, or prediabetes, and heart failure with reduced ejection fraction (SUGAR-DM-HF). *Circulation.* 2021 Feb;143(6):516-25.
71. Verma S, Mazer CD, Yan AT, Mason T, Garg V, Teoh H, et al. Effect of empagliflozin on left ventricular mass in patients with Type 2 diabetes mellitus and coronary artery disease. *Circulation.* 2019 Aug;140(21):1693-702.
72. Lee T, Chang N, Lin S. Dapagliflozin, a selective SGLT2 Inhibitor, attenuated cardiac fibrosis by regulating the macrophage polarization via STAT3 signaling in infarcted rat hearts. *Free Radic Biol Med.* 2017 Mar;104:298-310.
73. Yurista SR, Silljé HH, Oberdorf-Maass SU, Schouten E, Pavez Giani MG, Hillebrands J, et al. Sodium-glucose co-transporter 2 inhibition with empagliflozin improves cardiac function in non-diabetic rats with left ventricular dysfunction after myocardial infarction. *Eur J Heart Fail.* 2019 Jul;21(7):862-73.
74. Kang S, Verma S, Hassanabad AF, Teng G, Belke DD, Dundas JA, et al. Direct effects of empagliflozin on extracellular matrix remodelling in human cardiac myofibroblasts: Novel translational clues to explain EMPA-REG OUTCOME Results. *Can J Cardiol.* 2020 Apr;36(4):543-53.
75. Centre for Perioperative Care. Guideline for perioperative care for people with diabetes mellitus undergoing elective and emergency surgery. [Internet]. London (United Kingdom): Centre for Perioperative Care; 2021 [cited 2021 May 28]. Available from: <https://cpoc.org.uk/sites/cpoc/files/documents/2021-05/CPOC-Diabetes-Guideline2021.pdf>
76. Food and Drugs Administration. FDA revises labels of SGLT2 inhibitors for diabetes to include warnings about too much acid in the blood and serious urinary tract infections. [Internet]. Silver Spring (MD): Food and Drugs Administration; 2020 [cited 2021 May 28]. Available from: <https://www.fda.gov/drugs/drug-safety-and-availability/fda-revises-labels-sglt2-inhibitors-diabetes-include-warnings-about-too-much-acid-blood-and-serious>

## Anaesthesia for the adult patient with a Fontan circulation undergoing non-cardiac surgery

**Reza Yusoff MB BCh, BAO, FCARCSI, FANZCA**

**Department of Anaesthesia, Sir Charles Gairdner Hospital, Nedlands, Western Australia**

Dr Yusoff is a consultant cardiothoracic anaesthetist at Sir Charles Gairdner Hospital and a senior clinical lecturer at Notre Dame University, Fremantle. His interests in paediatric and cardiac anaesthesia has ultimately resulted in passion for adult congenital heart disease. He also runs one lung ventilation workshops at state and international levels.

**James Preuss MBBS, FANZCA, MC-CU, BSc (Hon)**

**Department of Anaesthesia, Sir Charles Gairdner Hospital, Nedlands, Western Australia**

Dr Preuss is a consultant cardiac anaesthetist and deputy lead of research for the Department of Anaesthesia, Sir Charles Gairdner Hospital. Dr Preuss has an interest in adult congenital heart disease and completed his fellowship at Barts Heart Centre which is one of the adult congenital heart disease referral centres for London.

**Shannon Matzelle, MBBS (Hons), FANZCA**

**Department of Anaesthesia, Sir Charles Gairdner Hospital, Nedlands, Western Australia**

Dr Matzelle is a consultant cardiac anaesthetist at Sir Charles Gairdner Hospital with special interests in anaesthesia for adults with congenital heart disease and perioperative echocardiography. Dr Matzelle is the co-ordinator for cardiac anaesthesia and perioperative echocardiography teaching at SCGH.

**Cameron Seamen MBBS, FRACP**

**Department of Cardiology, Perth Children’s Hospital, Nedlands, Western Australia**

Dr Seaman is a consultant paediatric cardiologist at Perth Children’s Hospital with subspecialty training in cardiac catheterisation at the University of Alberta, Canada. He has a special interest in single ventricle physiology and transcatheter interventions in children and adults with congenital heart disease.

### INTRODUCTION

Due to improvements in the early surgical and medical management of congenital heart disease (CHD), more patients with a range of such conditions are surviving into adulthood, and may require anaesthesia for unrelated surgical procedures or obstetric management<sup>1</sup>. One such group are patients who have undergone a Fontan procedure in early childhood to palliate a congenital single functional ventricle<sup>2</sup>. These patients have a persistent Fontan circulation and will require special considerations during subsequent anaesthesia and surgery, even if this does not directly involve the heart or great vessels. The aim of this article is to describe the Fontan procedure and its more recent modifications, discuss the physiological implications and common complications and provide guidelines for the perioperative management of patients for non-cardiac surgery with this rare condition.

### FONTAN PROCEDURE

The original creation of what is now known as the Fontan circulation was described by Fontan and Baudet in 1971<sup>3</sup>. The novel procedure, performed in three patients with tricuspid atresia, was described by the authors as “a procedure of physiological pulmonary blood flow restoration”. Fifty years later, despite several modifications to the original procedure, this concept is still being used to palliate numerous congenital defects with a functionally single ventricle.

In essence, the aim of the Fontan procedure is to separate the systemic and pulmonary venous returns, restoring the circulation to be “in series”, but without a sub-pulmonary ventricle<sup>4</sup>. It is usually a completion procedure, and most patients would have undergone previous surgery to “prepare” the pulmonary circulation. Once the Fontan circulation is completed, caval blood flows directly into the pulmonary artery; this was originally achieved by connecting the right atrium (RA) directly to the pulmonary artery (PA), described as the atrio-pulmonary connection or atrio-pulmonary (AP) Fontan (see Figure 1A). However, this original idea of using the right atrium (RA) as a power source to pump the systemic venous return into the pulmonary artery presented other difficulties: the flow through the RA created flow disturbances with consequent energy loss, atrial dilatation, thrombus formation and complex arrhythmias.

A number of modifications has been made since, and the ventricularisation of the right atrium as described in Fontan's original description has been superseded by other reparative techniques where baffles and conduits are placed to assist the flow of blood to the pulmonary artery. In Australia, between 2010–2018, almost 70 per cent of patients undergoing a Fontan operation received an extracardiac Fontan (see Figure 1C), with the remainder receiving a lateral tunnel Fontan (see Figure 1B)<sup>5</sup>. The year of a patient's surgical repair can give a clue to the operative technique: repairs performed up to the year 1990, were mostly AP Fontan, repairs performed in the 1990s would have likely received a lateral tunnel Fontan and almost all repairs after 2000 would have had an extracardiac Fontan<sup>5</sup>.

There is recent evidence for the superiority of the extracardiac Fontan, with shorter cardiopulmonary bypass times during its creation, superior haemodynamics, and longer freedom from arrhythmias<sup>6</sup>. This extra cardiac technique also reduces suture lines in the RA and excludes it from higher venous pressures while avoiding the placement of prosthetic material in the atrial chamber<sup>7</sup>.

### Figure 1. Diagram depicting the various types of Fontan procedures

Reprinted with permission: *Circulation*.2019;140:e234-e284.

©2019 American Heart Association, Inc.<sup>3</sup>

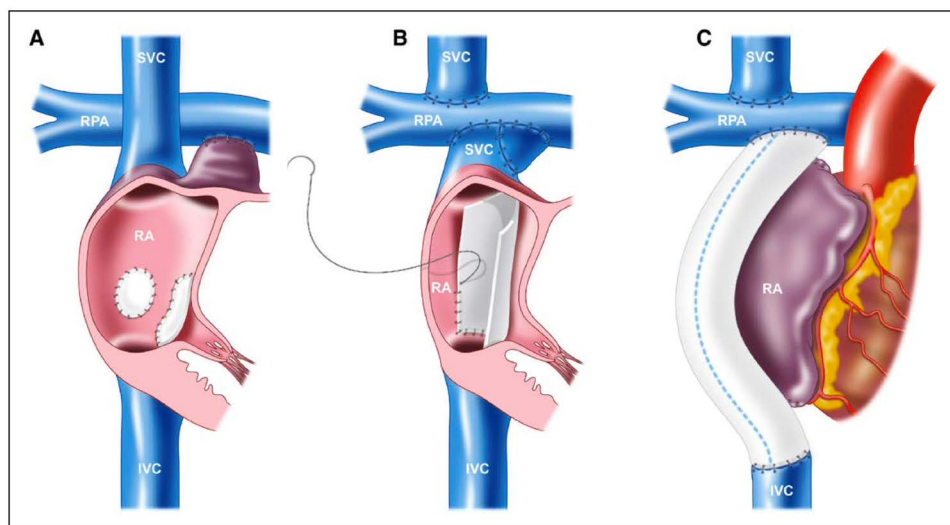

A) Atrio-pulmonary (AP) Fontan, B) Lateral tunnel Fontan, C) Extracardiac Fontan or also known as the Total Cavo-pulmonary connection (TCPC).

### PREVALENCE OF PATIENTS WITH A FONTAN CIRCULATION IN AUSTRALIA AND NEW ZEALAND

Currently, there are 1622 patients in the Australian and New Zealand (ANZ) Fontan registry, (4.5 per 100,000 population)<sup>8</sup>. Population projections from this data suggest that by 2045, the living Fontan population is expected to reach about 3000 patients (7.2 per 100,000 population)<sup>8</sup>. The life expectancy of Fontan patients is uncertain, however the longest ANZ survival data is 93 per cent at 20 years for patients with extracardiac Fontan, 88 per cent at 27 years for lateral tunnel Fontan, 67 per cent at 35 years with AP Fontan<sup>5</sup>. The AP technique is an independent risk factor for worse survival when compared to the extracardiac conduit technique<sup>5,9</sup>, therefore the survival rate at 35 years for extracardiac Fontan is likely to be better than that of the AP Fontan, once this data becomes available.

The primary diagnosis of the participants in the ANZ Fontan Registry in 2019 is represented in Table 1<sup>5</sup>.

While tricuspid atresia remains the most common indication of a Fontan operation, a heterogenous group of congenital cardiac defects could be offered a Fontan procedure, with improved life expectancy.

### Table 1. Indication for Fontan surgery in Australia

Data from the Australian and New Zealand Fontan Register 2019<sup>5</sup>.

Primary diagnosis	N	%
Tricuspid atresia	355	21.9
Double inlet left ventricle	264	16.3
Double outlet right ventricle	230	14.2
Hypoplastic left heart syndrome	193	11.9
Pulmonary atresia with intact ventricular septum	147	9.1
Unbalanced atrioventricular septal defect	137	8.4
Congenitally corrected transposition of the great arteries	128	7.9
Pulmonary atresia with ventricular septal defect	104	6.4
Ebstein's anomaly	34	2.1
Other	15	0.9
Missing	15	0.9
<b>Total</b>	<b>1622</b>	<b>100</b>

### THE PHYSIOLOGY OF THE FONTAN CIRCULATION

The complexity of the Fontan system is best considered in terms of 1) The systemic venous return and the cavo-pulmonary connection; 2) the pulmonary circulation; and 3) the single ventricle.

#### 1) The systemic venous return and cavo-pulmonary connection

As a single ventricle provides the power source for both the pulmonary and systemic circulation, the energy it produces dissipates as blood flows through the systemic arterial, and venous systems. Any remaining energy is used to drive blood through the pulmonary vasculature against the resistance of the pulmonary vascular bed. Therefore, the driving force required to maintain pulmonary blood flow depends on the difference in the pressure between the central venous (CVP) and the common atrial pressure (CAP) (also termed the transpulmonary gradient).

The cavo-pulmonary connection has been described as the "bottleneck" in the Fontan system resulting in upstream systemic venous congestion and downstream decreased flow<sup>10</sup>. The pulmonary impedance to flow results in chronic systemic venous congestion and hypertension and impaired cardiac output. The end result of this bottleneck is the limited ability to mobilise blood and increase the preload<sup>7</sup>. As the cardiac output is highly dependent on preload and pulmonary resistance in Fontan patients, it is imperative that these are kept within the optimal range (Fontan pressure <20mmHg, transpulmonary gradient <5mmHg and pulmonary vascular resistance <2WU/m<sup>2</sup>) for an optimal circulation<sup>11,12</sup>.

Patients with a lateral tunnel or extra cardiac Fontan circulation may have a surgically created fenestration, a small hole or "pop-off" that allows deoxygenated blood to bypass the pulmonary circulation to augment cardiac output, particularly in times of high pulmonary vascular resistance. A fenestration will therefore shunt deoxygenated blood to the systemic circulation which will increase the preload and cardiac output, though at the expense of reducing systemic oxygen saturation.

The negative pressure pulmonary pump contributes to the cavo-pulmonary flow to some degree<sup>13</sup>. Research in Fontan patients has demonstrated that the normal negative pressure inspiration created during breathing work contributes significantly to increase systemic venous blood flow and hence cardiac output, up to 30 per cent in one study<sup>14</sup>. In addition, a group from London has also demonstrated that the total hepatic venous flow is highly influenced by spontaneous ventilation, and inspiration markedly increases hepatic venous contribution to the total venous return<sup>15</sup>.

#### 2) The pulmonary circulation

The original publication by Choussat and Fontan et al, commonly known as the "Ten Commandments", detailed necessary prerequisites to indicate candidacy for the Fontan operation. Selection criteria including a low mean pulmonary arterial pressure and pulmonary vascular resistance ( $\leq 15$ mmHg and <4 Wood units/m<sup>2</sup> respectively) were predictive of early success<sup>16</sup>. The Fontan circulation is unique, as the PVR not only affects the preload,



but also contributes to the afterload of the sole ventricle. As described earlier, cavo-pulmonary flow is the main bottleneck of the circulation, and changes in the resistance at this part of the circulation significantly affects ventricular preload.

Fontan patients are at risk of developing an increase in pulmonary vascular resistance (PVR) which can be multifactorial, though a primary cause is thought to be due to the lack of pulsatility in the pulmonary arteries and the modification of the vascular bed due to reduced nitric oxide production in the pulmonary vessel endothelium<sup>17</sup>. There is also a higher rate of subclinical thromboembolism, with consequent increased resistance to the already low velocity flow in the pulmonary arteries.

The pulmonary blood flow is increased with inspiration and decreased, or even reversed, during the Valsalva manoeuvre<sup>13</sup>. Therefore, positive pressure ventilation (PPV) may cause haemodynamic instability in the perioperative period by significantly limiting pulmonary blood flow and thus cardiac output. However, the avoidance of PPV must be weighed against inadequate clearance of CO<sub>2</sub>, as an increase in CO<sub>2</sub> markedly increases PVR which will alter flow dynamics in the pulmonary vasculature and also affect cardiac output.

### 3) The single ventricle

The sole ventricle in a Fontan circulation could either be the anatomically right or left ventricle. Initial palliative procedures in single ventricle patients often leave the ventricle exposed to a chronic state of volume overload. As the circulation is modified towards the creation of a Fontan, there is a marked decrease in preload to the ventricle, with subsequent reduction in chamber size, wall stress and work. Hence, a ventricle that is used to having a large venous return is now deprived of the preload to which it was accustomed.

As the conservation of mass must occur and the ventricular mass has not changed, there will be a noticeable increase in ventricular wall thickness with the sudden reduction in preload described above<sup>18</sup>. A resulting decrease in end diastolic volume ensues in a ventricle with reduced ability to fill due to abnormalities of early relaxation. This resultant diastolic impairment could further reduce the pulmonary blood flow and increase the pulmonary artery pressure<sup>18</sup>.

An important implication is that the ventricle in the Fontan circulation no longer controls the cardiac output, but only pumps the blood volume allowed through the Fontan bottleneck<sup>10</sup>. As such, any isolated increase in ventricular contractility does not lead to an increase in cardiac output at rest.

## COMPLICATIONS OF THE FONTAN CIRCULATION

Arrhythmias are common in the Fontan population and may arise due to the underlying congenital heart disease or as a result of the surgical procedure itself<sup>19</sup>. Sinoatrial node dysfunction and atrial tachycardia may be attributed to direct damage to the SA node, atrial suture lines and/or atrial dilation and hypertrophy as a result of chronically elevated filling pressures<sup>27</sup>. Any non-sinus rhythm is significantly detrimental to cardiac output and results in further increases in filling pressures and therefore should be treated aggressively. The frequency of arrhythmias is significantly reduced with the extracardiac Fontan with conversion procedures considered for patients with classical Fontan circulations (AP and lateral tunnel) that are experiencing a significant arrhythmia burden.

Heart failure in the Fontan patient is multifactorial but progressive decline in function is generally related to pre-load limitation rather than contractility and afterload factors<sup>7</sup>. As previously stated, the absence of a sub-pulmonary ventricle leads to systemic venous and potentially pulmonary hypertension due to the lack of pulsatile flow resulting in a diminished ability to deliver the normal venous return and thus pre-load to the systemic ventricle<sup>20</sup>. In addition, the afterload is increased due the single ventricle needing to pump against the systemic and pulmonary vascular resistance with each cardiac cycle. The resulting increase in afterload produces a significant preload/afterload mismatch and results in a stiff, non-compliant, hypertrophied systemic ventricle with increased filling pressures and dilated atria.

The underlying congenital abnormalities may also result in reduced ventricle contractility and cardiac output<sup>21</sup>. This is especially true in congenital conditions where the right ventricle becomes the systemic ventricle. Ventricular function is further worsened with the presence of atrioventricular valve regurgitation, resulting in volume overload, ventricular dilation, reduced ventricular contractility and increased central venous, pulmonary and post capillary pressures<sup>2</sup>. These changes result in an overall reduction in oxygen delivery compared to patients with normal circulation, with no capacity to increase delivery during periods of physiological stress<sup>22</sup>.

There is a mild degree of cyanosis in all Fontan patients with SPO<sub>2</sub> levels in the low 90s<sup>23</sup>. This could be due to intracardiac shunting via the coronary sinus blood draining to the systemic ventricle, and/or extra cardiac pulmonary shunting. The saturations are worsened with exercise as all factors leading to the mild cyanosis at rest are exacerbated with physiological stress. However, resting saturation less than 90 per cent are generally not normal in this population and are can be suggestive of clinically significant pathology. Such pathology

includes right to left intracardiac shunt in patients with an AP Fontan, presence of a fenestrated lateral tunnel or extracardiac Fontan conduit, veno-venous collaterals draining from the systemic venous return to the pulmonary veins or atrium or pulmonary arteriovenous malformations<sup>23</sup>. Veno-venous collaterals often worsen during states of venous congestion and increased pulmonary resistance. This worsens cyanosis by increasing shunt through these collaterals, which may be the first indication of a failing Fontan. A consequence of the chronic state of mild hypoxia seen in Fontan patients, haemoglobin levels are often elevated, resulting in an increased blood viscosity and this may lead to a relative iron deficient state<sup>2</sup>.

Thromboembolism is common, causes late morbidity and accounts for 8 per cent mortality in the Fontan population<sup>24</sup>. Aetiology is multifactorial and likely due to the chronic low flow circulation combined with the presence of prosthetic material, high blood viscosity and the procoagulant state (due to altered concentrations of antithrombin, proteins C and S and other clotting factors) seen in the Fontan population<sup>7,25</sup>. Silent embolic events can go unnoticed but chronic occurrence can lead to a significant increase in pulmonary resistance further hampering pulmonary blood flow. As a result, anticoagulation and antiplatelet therapy is commonly used in this population.

Some extent of liver disease is universal across the Fontan population with some damage thought to have occurred prior to the Fontan procedure itself. However, like all chronic diseases the progression differs between individuals<sup>26</sup>. The chronic state of systemic venous hypertension combined with a low cardiac output in this population results in centrilobar congestion, necrosis, inflammation and ultimately liver fibrosis<sup>27</sup>. Repeated ischaemic insult, combined with chronic congestion over time results in the progression of fibrosis to cirrhosis and eventually clinical sequelae of portal hypertension with hepatocellular carcinoma in some individuals<sup>26,28</sup>. The resulting changes in the portal system can result in hepatomegaly, raised liver enzymes, thrombocytopenia and synthetic dysfunction resulting in coagulopathy and hypoalbuminaemia. Despite these changes, fulminant liver failure, without overt circulatory failure, is extremely rare<sup>27</sup>.

Luminal protein loss occurs in approximately 10 per cent of Fontan patients<sup>29</sup>. Protein losing enteropathy (PLE), as a result of enteric loss, and plastic bronchitis (PB), as a result of bronchial loss, occurs as a result of a break in integrity of the respecting mucosa leading to a gross loss of plasma proteins<sup>27</sup>. Protein-losing enteropathy results in hypoalbuminaemia and decreased oncotic pressure induced ascites and peripheral oedema. Plastic bronchitis does not result in hypoalbuminaemia due to the smaller surface area of the bronchial tree. However, the proteinaceous material accumulates and form casts in the bronchial tree which can hamper oxygen exchange, worsen pulmonary hypertension and further diminish oxygen supply<sup>30</sup>. Both PLE and PB are significant risk factors for late mortality<sup>27</sup>.

## PERIOPERATIVE MANAGEMENT OF THE ADULT FONTAN PATIENT

As more Fontan patients survive into adulthood, anaesthetists will be called on more commonly to manage these patients in the non-cardiac surgical setting. Fontan patients carry a higher perioperative risk, not only due to their complex haemodynamics, but also due to the potential for other significant congenital lesions or syndromes that might impact perioperative management, for example, difficult airway. The Fontan specific complications that develop later in life will also impact their perioperative management and increase their perioperative risk.

Procedures on Fontan patients should be performed in centres that are familiar with these patients and have expertise in managing them preoperatively, intraoperatively and postoperatively. Rapid access to multidisciplinary teams that look after such patients is essential. Significant caution and planning is essential when performing procedures on Fontan patients due to the complexity of their physiology and the potential to rapidly decompensate, particularly during general anaesthesia.

The preoperative assessment of the Fontan patient has several special considerations. It is necessary to understand the original pathology with type and timing of previous palliative Fontan formation surgery, subsequent interventions (for example, pacemaker insertion) as well as current Fontan complications and treatment. According to current guidelines<sup>31,32</sup>, Fontan patients should be reviewed by adult congenital heart disease cardiologists in the outpatient setting annually unless more frequent assessment is clinically indicated. Consultation with the patients' cardiologists and access to clinic summaries, recent investigations and current treatments are the minimum requirement for the preoperative assessment these patients<sup>31</sup>.

The physiology underpinning the Fontan circulation of elevated venous pressure and restricted cardiac output will impact the ability of the single ventricle to cope with the perioperative demands of surgery and anaesthesia. A "failing Fontan" with inadequate cardiac output as opposed to the "well Fontan" is an important distinction to make when assessing perioperative risk. The most current cardiology review as well as recent cardiac imaging should highlight any evidence of a "failing Fontan".

Patients' exercise and functional tolerance can be formally measured using cardiopulmonary testing and recent changes are a very useful addition to the assessment. An assessment of cardiac rhythm by clinical examination and electrocardiogram should be performed in all patients, as tachyarrhythmias, especially seen in those with AP Fontan, are poorly tolerated. Many Fontan patients with a history of arrhythmia may have a permanent pacemaker (epicardial or endocardial) inserted. Generator location, its baseline setting and its response to a magnet should be determined. An intra-abdominal pacing box, if present, may interfere with abdominal surgery, so the surgical team need to be made aware of its location. Abnormal oxygen saturations can be suggestive of elevated pulmonary pressures, collateral formation and/or ventricular dysfunction, and would require further investigation<sup>32</sup>.

Preoperative laboratory examination should include assessment of haemoglobin and iron stores as well as renal and hepatic functions (including coagulation studies). Crossed matched blood should be available for procedures where blood loss is anticipated, because multiple previous transfusions may have resulted in the development of antibodies.

Many Fontan patients will be receiving thromboprophylaxis due to the increased risk of thrombosis. Managing these medications will need to be done on a case-by-case basis and in consultation with the managing cardiologist. Other cardiac-related medications that patients may be taking include diuretics, ACE inhibitors, antihypertensives, anti-arrhythmic drugs and pulmonary vasodilators. These should be continued unless recommended by the patient's cardiologist, although it may be wise to withhold diuretics during the fasting period to avoid dehydration. Fontan patients should avoid prolonged fasting periods and receive intravenous hydration during fasting to reduce thrombosis risk that the high viscosity brings<sup>2,32</sup>.

## INTRAOPERATIVE MANAGEMENT

Due to the rarity of the condition, there are few outcome studies to guide management. As a result, the patient's previous surgery and an understanding of the anatomy will dictate where and what intravascular access and monitoring can be performed. The use of ultrasound imaging may be required to allow for cannulation of a radial artery for arterial blood pressure monitoring. The presence of an arteriovenous fistula (placed to resolve pulmonary arteriovenous malformations), previous Blalock-Taussig shunt or ligation of a subclavian artery with aortic arch repair, may preclude the vessel being used for monitoring.

The Fontan patient requires high venous pressure to drive non-pulsatile flow through the lungs. Large bore venous access is required for most interventions performed on these patients, particularly for procedures that are associated with volume loss through third space (for example, abdominal or thoracic surgery) or blood loss. Caution should be exercised when advancing subclavian or neck central venous catheters as the usual SVC to right atrial junction may be significantly altered in these individuals, for example with development of a Glenn Shunt<sup>3</sup>, and as such placing an intravascular device into these connections run the risk of trauma, stenosis and clot formation and should only be done after careful consideration of risks versus benefits.

In terms of operative management and conduct of anaesthesia, the principles of maintaining pulmonary blood flow and therefore cardiac output in the absence of a sub-pulmonary ventricle is the priority. Therefore, maintenance of adequate oxygen saturations and normocarbia should be ensured, with avoidance of acidosis or excessive positive pressure ventilation that could contribute to an increase in pulmonary vascular resistance. Such strategies should include limiting peak inspiratory pressure (<20 cm H<sub>2</sub>O), using low respiratory rates (<20 breaths per minute) and short inspiratory times and avoiding excessive positive end-expiratory pressure<sup>33</sup>.

Maintaining venous return and preload is also crucial in maintaining pulmonary blood flow, so blood and third space losses should be replaced in a timely manner. It is also essential that anaesthetists are aware of surgical techniques that may decrease venous return due to high intracavity pressures such as laparoscopic, and thoracoscopic procedures.

Where possible, early extubation post procedure should be targeted to minimise complications from mechanical ventilation and re-establish negative inspiratory pressure to improve pulmonary blood flow<sup>33</sup>.

## PREGNANT PATIENTS WITH A FONTAN CIRCULATION

The WHO Classification of Maternal Cardiovascular Risk defines pregnant patients with a Fontan circulation as grade III risk which infers significantly increased mortality and severe morbidity risk<sup>34</sup>. In regards to family planning, expert counselling is suggested due to the substantial risk of pregnancy and delivery. Despite this there is an increase in the frequency of patients with Fontan circulation presenting for pregnancy-related care over the past few decades.

Parturients with a Fontan circulation provide additional challenges to the anaesthetist as the changes of pregnancy compound an already unique physiology. It is imperative to implement a detailed multidisciplinary

approach to plan for the safest modality of delivery and clearly document the plan in the patients' medical records. Some physiological changes of pregnancy are favourable to a Fontan patient (for example, reduction in PVR), while increases in preload, afterload and heart rate could be detrimental in patients with an already poorly functioning circulation.

Where vaginal delivery is suitable, an elective induction of labour under controlled conditions is recommended with consideration of invasive blood pressure and ECG monitoring, especially when neuraxial anaesthesia is used<sup>35</sup>. The practical planning of induction should plan for the delivery to occur when adequate staffing is available for assistance<sup>35</sup>. Labouring should be performed in the left lateral position to prevent interruption of venous return. Valsalva during the second stage of delivery should be avoided and a passive second stage is more appropriate with the use of forceps and vacuum to facilitate delivery with the minimal possible physiological stress placed on the mother<sup>35</sup>. Cautious early neuraxial anaesthesia techniques can facilitate a passive second stage delivery and suppress the Valsalva reflex of fetal pelvic descent<sup>35</sup>.

Caesarean delivery is based on obstetric indications or in Fontan patients with poor ejection fraction, symptomatic heart failure or arrhythmias requiring a more expedient delivery<sup>35</sup>. A review of literature has demonstrated that both neuraxial and general anaesthesia can safely be performed in these patients<sup>36,37</sup>, with consideration of the vasodilation and reduction in pre-load that both techniques cause. Pharmacological uterotonic agents should also be used cautiously and in general oxytocin should be administered as an infusion to prevent systemic vasodilatation and impaired venous return that could occur with bolus administration. Furthermore, prostaglandin analogues as well as ergot alkaloids should be avoided due to the increase pulmonary vascular resistance caused by these medications<sup>38</sup>.

Fluid shifts and autotransfusion from the involuting uterus during the 24 hours following delivery is concern and may place additional strain on a failing Fontan circulation and can result in acute heart failure in the post-partum period<sup>35,39</sup>. Patients should be monitored in the intensive care setting for 24-48 hours following delivery.

## ANTIBIOTIC PROPHYLAXIS

Current Australian endocarditis prophylactic guidelines recommend endocarditis prophylaxis in congenital heart disease only in patients with an unrepaired cyanotic defect (including palliative shunts and conduits) or patients with residual defects close to the site of a prosthetic patch or device<sup>40</sup>. Prophylaxis should only be given for procedures associated with a high risk of bacteraemia, that is, dental, dermatological, respiratory tract, genitourinary and gastrointestinal tract procedures<sup>40</sup>.

## CONCLUSION

The prevalence of patients with the Fontan procedure and their survival rate have both significantly increased over the past five decades since the procedure was initially introduced<sup>5,41,42</sup>. As a result, more patients with Fontan circulation are presenting for non-cardiac surgery or obstetric management. It is essential that anaesthetists caring for these patients have an understanding of the anatomical, physiological, and pathophysiological changes associated with the Fontan circulation, and the effects anaesthesia has on the complex pulmonary and systemic circulation. Procedures on Fontan patients should be performed in centres that are familiar with these patients and have expertise in managing them preoperatively, intraoperatively and postoperatively. Rapid access to multidisciplinary teams that care for Fontan patients is essential.

## REFERENCES

1. Eagle SS, Daves SM. The adult with fontan physiology: Systematic approach to perioperative management for noncardiac surgery. *J Cardiothorac Vasc Anesth.* 2011; 25(2):320-34.
2. Rychik J, Atz AM, Celermajor DS, Deal BJ, Gatzoulis MA, Gewillig MH, et al. Evaluation and management of the child and adult with fontan circulation: A scientific statement from the american heart association. *Circulation.* 2019;CIR0000000000000696.
3. Fontan F, Baudet E. Surgical repair of tricuspid atresia. *Thorax.* 1971; 26(3):240-8.
4. Baumgartner H, De Backer J, Babu-Narayan SV, Budts W, Chessa M, Diller GP, et al. 2020 esc guidelines for the management of adult congenital heart disease. *Eur Heart J.* 2021; 42(6):563-645.
5. Australian & New Zealand Fontan Registry. Australian & new zealand fontan registry: Report 2019. Murdoch Children's Research Institute, Royal Children's Hospital Melbourne, Flemington Road Parkville VIC 3052 Australia 2020 September 2020. 1-12p.
6. Backer CL, Deal BJ, Kaushal S, Russell HM, Tsao S, Mavroudis C. Extracardiac versus intra-atrial lateral tunnel fontan: Extracardiac is better. *Semin Thorac Cardiovasc Surg Pediatr Card Surg Annu.* 2011; 14(1):4-10.
7. de Leval MR, Deanfield JE. Four decades of fontan palliation. *Nat Rev Cardiol.* 2010; 7(9):520-7.
8. Schilling C, Dalziel K, Nunn R, Du Plessis K, Shi WY, Celermajor D, et al. The fontan epidemic: Population projections from the australia and new zealand fontan registry. *Int J Cardiol.* 2016; 219:14-9.

9. d'Udekem Y, Iyengar AJ, Galati JC, Forsdick V, Weintraub RG, Wheaton GR, et al. Redefining expectations of long-term survival after the fontan procedure: Twenty-five years of follow-up from the entire population of australia and new zealand. *Circulation*. 2014; 130(11 Suppl 1):S32-8.
10. Gewillig M, Brown SC. The fontan circulation after 45 years: Update in physiology. *Heart*. 2016; 102(14):1081-6.
11. Stumper O, Penford G. Catheter hemodynamic assessment of the univentricular circulation. *Ann Pediatr Cardiol*. 2017; 10(2):167-74.
12. Egbe AC, Connolly HM, Miranda WR, Ammash NM, Hagler DJ, Veldtman GR, et al. Hemodynamics of fontan failure: The role of pulmonary vascular disease. *Circ Heart Fail*. 2017; 10(12).
13. Van De Bruaene A, Kutty S. The peculiar challenges of breathing and exercising with a fontan circulation. *Am J Physiol Heart Circ Physiol*. 2019; 316(2):H311-H3.
14. Fogel MA, Weinberg PM, Rychik J, Hubbard A, Jacobs M, Spray TL, et al. Caval contribution to flow in the branch pulmonary arteries of fontan patients with a novel application of magnetic resonance presaturation pulse. *Circulation*. 1999; 99(9):1215-21.
15. Hsia TY, Khambadkone S, Redington AN, Migliavacca F, Deanfield JE, de Leval MR. Effects of respiration and gravity on infradiaphragmatic venous flow in normal and fontan patients. *Circulation*. 2000; 102(19 Suppl 3):III148-53.
16. Choussat A, Fontan F, Besse P. Paediatric cardiology. Edinburgh, Scotland: Churchill Livingstone; 1977. Selection criteria for the fontan procedure; p. 559-66.
17. Hauck A, Porta N, Lestrud S, Berger S. The pulmonary circulation in the single ventricle patient. *Children (Basel)*. 2017; 4(8).
18. Redington A. The physiology of the fontan circulation. *Progress in Pediatric Cardiology*. 2006; 22:179-86.
19. Blaufox AD, Sleeper LA, Bradley DJ, Breitbart RE, Hordof A, Kanter RJ, et al. Functional status, heart rate, and rhythm abnormalities in 521 fontan patients 6 to 18 years of age. *J Thorac Cardiovasc Surg*. 2008; 136(1):100-7, 7 e1.
20. Beghetti M. Fontan and the pulmonary circulation: A potential role for new pulmonary hypertension therapies. *Heart*. 2010; 96(12):911-6.
21. Sluysmans T, Sanders SP, van der Velde M, Matitiau A, Parness IA, Spevak PJ, et al. Natural history and patterns of recovery of contractile function in single left ventricle after fontan operation. *Circulation*. 1992; 86(6):1753-61.
22. Giardini A, Hager A, Pace Napoleone C, Picchio FM. Natural history of exercise capacity after the fontan operation: A longitudinal study. *Ann Thorac Surg*. 2008; 85(3):818-21.
23. Deal BJ, Jacobs ML. Management of the failing fontan circulation. *Heart*. 2012; 98(14):1098-104.
24. Khairy P, Fernandes SM, Mayer JE, Jr., Triedman JK, Walsh EP, Lock JE, et al. Long-term survival, modes of death, and predictors of mortality in patients with fontan surgery. *Circulation*. 2008; 117(1):85-92.
25. Callegari A, Christmann M, Albisetti M, Kretschmar O, Quandt D. Single ventricle physiology patients and coagulation abnormalities: Is there a relationship with hemodynamic data and postoperative course? A pilot study. *Clin Appl Thromb Hemost*. 2019; 25:1076029619888695.
26. Tellez L, Rodriguez-Santiago E, Albillos A. Fontan-associated liver disease: A review. *Ann Hepatol*. 2018; 17(2):192-204.
27. Rychik J, Goldberg DJ. Late consequences of the fontan operation. *Circulation*. 2014; 130(17):1525-8.
28. Ghaferi AA, Hutchins GM. Progression of liver pathology in patients undergoing the fontan procedure: Chronic passive congestion, cardiac cirrhosis, hepatic adenoma, and hepatocellular carcinoma. *J Thorac Cardiovasc Surg*. 2005; 129(6):1348-52.
29. Bejiqi R, Retkoceri R, Zeka N, Bejiqi H, Vuqiterna A, Maloku A. Treatment of children with protein - losing enteropathy after fontan and other complex congenital heart disease procedures in condition with limited human and technical resources. *Mater Sociomed*. 2014; 26(1):39-42.
30. Gewillig M. The fontan circulation. *Heart*. 2005; 91(6):839-46.
31. Zentner D, Celermajer DS, Gentles T, d'Udekem Y, Ayer J, Blue GM, et al. Management of people with a fontan circulation: A cardiac society of australia and new zealand position statement. *Heart Lung Circ*. 2020; 29(1):5-39.
32. Adler AC, Nathan AT. Perioperative considerations for the fontan patient requiring noncardiac surgery. *Anesthesiol Clin*. 2020; 38(3):531-43.
33. Mossad EB, Motta P, Vener DF. Anesthetic considerations for adults undergoing fontan conversion surgery. *Anesthesiol Clin*. 2013; 31(2):405-19.
34. Thorne S, MacGregor A, Nelson-Piercy C. Risks of contraception and pregnancy in heart disease. *Heart*. 2006; 92(10):1520-5.
35. Canobbio MM, Warnes CA, Aboulhosn J, Connolly HM, Khanna A, Koos BJ, et al. Management of pregnancy in patients with complex congenital heart disease: A scientific statement for healthcare professionals from the american heart association. *Circulation*. 2017; 135(8):e50-e87.
36. Tiouririne M, de Souza DG, Beers KT, Yemen TA. Anesthetic management of parturients with a fontan circulation: A review of published case reports. *Semin Cardiothorac Vasc Anesth*. 2015; 19(3):203-9.
37. Monteiro RS, Dob DP, Cauldwell MR, Gatzoulis MA. Anaesthetic management of parturients with univentricular congenital heart disease and the fontan operation. *Int J Obstet Anesth*. 2016; 28:83-91.
38. Bishop L, Lansbury A, English K. Adult congenital heart disease and pregnancy. *BJA Educ*. 2018; 18(1):23-9.
39. Garcia Ropero A, Baskar S, Roos Hesselink JW, Girmius A, Zentner D, Swan L, et al. Pregnancy in women with a fontan circulation: A systematic review of the literature. *Circ Cardiovasc Qual Outcomes*. 2018; 11(5):e004575.
40. Prevention of infective endocarditis. In electronic therapeutic guidelines complete. Retrieved from [https://tgldcdp-tg-org-au.Qelibresources.Health.Wa.Gov.Au/viewtopic?Topicfile=infection-prevention-endocarditis#toc\\_d1e77](https://tgldcdp-tg-org-au.Qelibresources.Health.Wa.Gov.Au/viewtopic?Topicfile=infection-prevention-endocarditis#toc_d1e77) [Internet]. 2019.
41. Coats L, O'Connor S, Wren C, O'Sullivan J. The single-ventricle patient population: A current and future concern a population-based study in the north of england. *Heart*. 2014; 100(17):1348-53.
42. Dennis M, Zannino D, du Plessis K, Bullock A, Disney PJS, Radford DJ, et al. Clinical outcomes in adolescents and adults after the fontan procedure. *J Am Coll Cardiol*. 2018; 71(9):1009-17.

## Anaesthetic considerations in the patient with Eisenmenger syndrome

### Michael H Toon OLY BPharm MBBS (Hons) FANZCA

#### The Prince Charles Hospital, Brisbane, Queensland

Dr Michael Toon is currently a fellow in cardiothoracic anaesthesia at The Prince Charles Hospital. Among his interests are obstetric anaesthesia, adult congenital heart disease and anaesthesia history and heritage. His previous work in pharmacy specialised in chemotherapeutic compounding and toxicology information. He is indebted to those colleagues who gave time and advice through the preparation of this manuscript.

### Cameron Graydon MBBS (Hons) FANZCA CHIA

#### Queensland Children's Hospital, Brisbane, Queensland

Dr Cameron Graydon is a paediatric cardiac anaesthetist at Queensland Children's Hospital. He is interested in data and quality improvement and is doing a PhD in learning health systems. His interest in pulmonary hypertension comes from having trained in cardiac anaesthesia at Papworth and Great Ormond Street Hospitals, the UK centres for adult and paediatric vascular diseases. He has worked for the International Children's Heart Foundation, undertaking many surgeries for patients with congenital cardiac disease and severe pulmonary hypertension.

## INTRODUCTION

Eisenmenger syndrome (ES) comprises a severe phenotype of pulmonary hypertension resulting in right to left flow through an intracardiac or aortopulmonary shunt, usually from congenital cardiac disease. It carries a significant risk of perioperative mortality<sup>1</sup>. The syndrome is named after Dr Victor Eisenmenger who was appointed Court Physician to Archduke Francis Ferdinand from 1895 until the archduke's assassination in 1914<sup>2</sup>. During his career, Dr Eisenmenger published an article titled "Die Angeborenen Defecte der Kammerscheidewand des Herzens" (the congenital ventricular septal defects of the heart) in 1897<sup>3</sup>. This paper described a 32-year-old man with cyanosis and episodes of breathlessness who succumbed eventually to haemoptysis<sup>4,5</sup>. More than half a century later, in 1958, British cardiologist Dr Paul Wood defined Eisenmenger syndrome as any condition in which there is a communication between pulmonary and systemic circulations producing pulmonary vascular disease of such severity that right-to-left shunting occurs at atrial, ventricular or aortic level<sup>6</sup>.

The reported prevalence of the syndrome among adult congenital heart disease varies from 1 per cent in the 2007 Dutch CONCOR registry to 5.7 per cent in the Euro Heart Survey in 2005. Advances in diagnostic procedures and cardiac surgical techniques have prevented pulmonary arterial hypertension (PAH) in most children with congenital heart disease (CHD); however, a significant proportion of treated patients surviving into adulthood may still develop PAH due to ineffective pulmonary artery banding or residual shunts. Unrepaired shunt lesions often persist in developing countries and patients may present with more advanced disease<sup>7,8</sup>.

Prior to the 1970s approximately 50 per cent of children requiring intervention died within their first year and less than 15 per cent survived into adulthood. Today, more than 85 per cent of patients with CHD survive into adulthood<sup>9</sup>. When Eisenmenger syndrome does develop, repair of the underlying defect is largely contraindicated<sup>7</sup> but patients may lead active lives into early adulthood, though survival into the sixth decade is rare<sup>10</sup>. Eisenmenger syndrome is particularly challenging for the anaesthetist, especially in the obstetric population where increased physiological demands are already in play<sup>11</sup>. While the risk of anaesthesia and childbirth are considerable in patients with Eisenmenger syndrome an understanding of the pathophysiology and likely complications can improve their outlook<sup>12</sup>.

The purpose of this narrative review is to outline the classification, pathophysiology and latest anaesthetic management for this patient population. We also review the current guidelines related to Eisenmenger syndrome patients with COVID-19 and non-invasive haemodynamic monitoring.

## AETIOLOGY AND CLASSIFICATION

Eisenmenger syndrome is the commonest presentation of congenital cyanotic heart disease in adults, whereas for children Tetralogy of Fallot predominates<sup>13</sup>. The World Health Organization's aetiological classification of pulmonary hypertension (PAH) classifies five categories with Eisenmenger syndrome in group 1<sup>14,15</sup>. The primary pathophysiological cascade begins with a systemic-to-pulmonary shunt as outlined in Figure 1<sup>8</sup>.

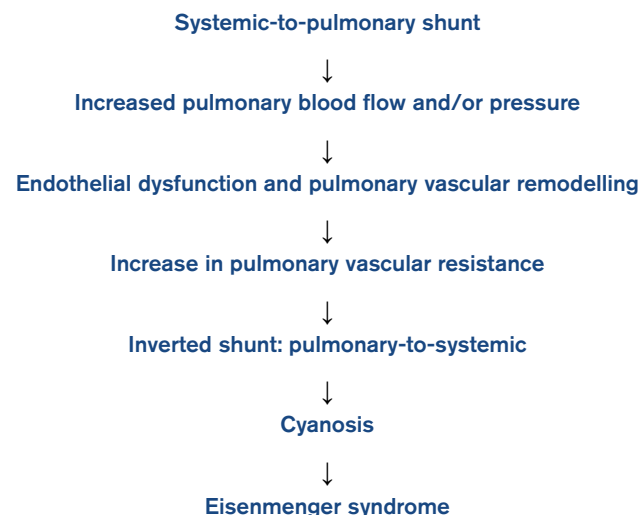
**Figure 1. Pathophysiological cascade**

Lesions accounting for the development of Eisenmenger syndrome can occur at all cardiac levels with the progression often determined by the underlying defect and genetic predisposition. In Wood's classic series, 80 per cent of cases that were secondary to a ventricular septal defect presented during infancy while 92 per cent of cases, secondary to an atrial septal defect, presented in adult life<sup>16</sup>. Approximately 50 per cent of patients with large unrepaired ventricular septal defects (VSD) (>1.5cm), 10 per cent of patients with large unrepaired atrial septal defects (ASD) and almost all patients with unrepaired truncus arteriosus are at risk of developing the syndrome<sup>17</sup>. The pathophysiological classification of CHD with systemic-to-pulmonary shunt leading to PAH is outlined in Table 1.

**Table 1. Classification of CHD with systemic-to-pulmonary shunt**

1	Type	Simple pre-tricuspid shunts (ASD, total or partial unobstructed anomalous pulmonary venous return) Simple post-tricuspid shunts (VSD, PDA) Combined shunts Complex CHD (AVSD, TA, TGA with VSD +/- PDA)
2	Dimension	Haemodynamic (restrictive, non-restrictive) Anatomical (small-to-moderate [ASD <2cm and VSD <1cm], large)
3	Direction	Systemic-to-pulmonary Pulmonary-to-systemic Bidirectional
4	Extra-cardiac abnormalities	Present Absent

ASD: atrial septal defect, VSD: ventricular septal defect, PDA: patent ductus arteriosus, AVSD: atrio-ventricular septal defect, TA: truncus arteriosus, TGA: transposition of the great arteries.

The incidence of PAH in pre-tricuspid shunts (ASD and anomalies of pulmonary veins), which induce predominantly a volume overload on the right ventricle and on the pulmonary circulation, is lower than those of post-tricuspid shunts which produce a combined pressure and volume overload (mainly large VSD, PDA and atrio-ventricular septal defects)<sup>8</sup>. Patients with Down syndrome have a propensity to develop pulmonary hypertension and as a result contribute disproportionately to the incidence of ES, though with early screening and treatment this has decreased. A recent multivariate analysis found that age, pre-tricuspid shunt, lower

oxygen saturation at rest, absence of sinus rhythm and pericardial effusion identified a high-risk subgroup of patients. Interestingly, functional status (NYHA class), RV function (as assessed by tricuspid annular plane systolic excursion [TAPSE] on trans-thoracic echocardiography), routine laboratory data and use of pulmonary arterial vasodilators provided no additional useful prognostic information<sup>18</sup>.

## PATHOPHYSIOLOGY

The underlying pathophysiology involves an adaptive response to increased stretch, shear stress and pressure on the arterioles that protects against heart failure and pulmonary oedema from excessive left to right shunting. The process involves endothelial responses, vasoconstriction, vascular remodelling and an eventual maladaptive pathology with cancer-like angioproliferation, pulmonary arterial thrombosis, platelet dysfunction, media hypertrophy and fibrosis<sup>19</sup>. Vasoconstriction results from an imbalance between vasodilators (for example, nitric oxide and prostacyclin) and constrictors (for example, thromboxane A2 and endothelin) in the pulmonary circulation and expression of vascular endothelial and fibroblast growth factors promotes vascular remodelling and increased intracellular matrix deposition<sup>20</sup>.

Structural changes within the pulmonary vascular bed begin with extension of muscle into normally non-muscular peripheral arteries. Later, media hypertrophy develops in the proximal muscular pulmonary arteries and finally a reduction in the capacitance and cross-sectional area of the pulmonary vasculature results in an increase in pulmonary vascular resistance (PVR) and mean pulmonary artery pressure. The histological progression proposed by Edwards and Heath in 1958 consists of six grades from medial hypertrophy of small muscular arteries to intimal cellular proliferation, concentric fibrosis, plexiform-glomerular proliferations, aneurysms and fibrinoid necrosis. These irreversible changes result in elevation of PVR and shunt reversal<sup>21</sup>.

## Clinical manifestations

Eisenmenger syndrome is a multi-system disease, displaying signs and symptoms of central cyanosis, dyspnoea, fatigue, haemoptysis, syncope and right-heart failure with progressive deterioration of function over time (see Table 2). Survival, while less than that of the general population, is better than that of idiopathic PAH in patients of a comparable functional class<sup>22</sup>. Right-to-left shunting in the presence of severe PAH sustains cardiac output at the expense of arterial hypoxaemia. In the presence of right ventricular failure, shunting is a mechanism for decreasing the loading on the ventricle and right-to-left shunting acts as a relief valve, tending to preserve function; this has been hypothesized to account for the differences in outcomes between Eisenmenger and idiopathic PAH patients<sup>23</sup>. Pulmonary vascular resistance was previously believed to be fixed in these patients, but there is now evidence that there is a degree of reversibility<sup>10</sup>, likely from heterogeneity of disease in the lung vasculature and reversible pathological processes<sup>24</sup>.

Decreases in systemic vascular resistance (SVR) are likely to result in increases in right-to-left shunting, worsening cyanosis and have been associated with cardiovascular collapse and death. Sudden increases in SVR may lead to a decrease in ventricular function, especially if associated with a rise in PVR. Unsurprisingly, arrhythmias are usually poorly tolerated<sup>25</sup>. Physical activity is associated with aggravated cyanosis due to a limited capacitance to increase pulmonary blood flow and an increase in right-to-left shunting. Patients are at risk for sudden cardiac death during strenuous physical activity<sup>26</sup>.

While Eisenmenger syndrome patients with post-tricuspid communications are usually diagnosed in infancy, pre-tricuspid communications more often diagnosed in adult life. Patients with pre-tricuspid shunts develop right ventricular (RV) pressure overload later, so RV adaptation and microvascular perfusion mechanisms may be more susceptible to failing. Eisenmenger patients due to PDAs are less symptomatic due to carotid chemoreceptors being exposed to the higher blood oxygen saturations being ejected into the upper body. This results in detectable differential cyanosis with lower oxygen saturation in the lower limbs. When the carotid chemoreceptors sense low oxygen, this contributes to increased ventilatory drive, arousal response to hypoxia during sleep, upper airway muscle activity and sympathetic tone<sup>27</sup>.

Multiple derangements of coagulation contribute to the pathology of ES. Platelet dysfunction occurs by several different mechanisms including chronic consumption and fragmentation in the pulmonary vasculature, leading to increased turn over and aggregation. Other abnormalities such as elevations of plasma von Willebrand factor antigen (vWF:Ag) and anti-β2-glycoprotein occur<sup>28</sup> while Vitamin-K dependant factor deficiency, factor V and von Willebrand factor deficiency, hypofibrinogenemia and increased fibrinolysis contribute. Megakaryocytes bypassing the pulmonary vascular bed lodge in nail bed capillaries and may have a role in the aetiology of clubbing and hypertrophic pulmonary osteoarthropathy<sup>29</sup>.

## Clinical relevance

Over the past decades, there has been a shift in the cause of death from primarily peri-procedural and haemoptysis related to (in descending order) heart-failure, infection, sudden cardiac death, thrombosis and haemorrhage.

The key to the relative longevity of Eisenmenger syndrome patients compared to other forms of PAH lies in the unique physiology related to the shunt and adaptation of the right ventricle<sup>17</sup>. Patients with post-tricuspid (ventricular and aortopulmonary shunts) appear to be more resistant to right ventricular failure and those lesions with a propensity to earlier development of PAH tended towards better maintained RV function, for example atrioventricular septal defects<sup>23</sup>. This could be because the regression of ventricular muscle and capillarisation that would normally occur in post-foetal life in response to lowered pulmonary vascular pressures does not occur and the ventricular off-loading through the shunt helps preserve RV adaptation. The right-to-left shunt provides a mechanism for paradoxical emboli to the systemic circulation, including septic emboli, thromboemboli and air emboli, leading to cerebrovascular accidents and brain abscesses. Moreover, cyanosis triggers erythrocytosis and is associated with bleeding diathesis and thrombosis<sup>30</sup>.

Renal dysfunction is common, mechanisms may include pre-renal failure from low cardiac output state and secondary to glomerular abnormalities because of hypoxaemia and hyperuricaemia<sup>31</sup>. Chronic hypoxaemia leads to secondary erythrocytosis and predisposition to calcium bilirubinate gallstones (increased turnover of heme) and subsequent cholecystitis increases the requirement for cholecystectomy<sup>32</sup>.

**Table 2. Summary of complications of Eisenmenger syndrome by system (adapted from Chaix et al 2019<sup>33</sup>)**

<b>Cardiovascular system</b>
Arrhythmias and sudden cardiac death
Valvular heart disease
Endocarditis
Systolic and diastolic right and left ventricular dysfunction
<b>Respiratory system</b>
Pulmonary arterial thrombus
Pulmonary arterial aneurysms and rupture
Haemoptysis
Veno-venous collaterals and fistula
<b>Gastrointestinal system</b>
Gallstones (secondary to erythrocyte turnover)
Hyperbilirubinaemia
<b>Haematological system</b>
Erythrocytosis
Thrombocytopenia
Iron deficiency
Hyperviscosity syndrome*
Thrombosis
Deficiency of Vitamin K dependent factors, factor V and von Willebrand factor
Increased bleeding tendency
<b>Urinary system</b>
Hyperuricaemia
Gout
Renal Failure
<b>Neurological system</b>
Stroke and trans-ischaemic attack
Brain abscess

### Endocrine system

Neuroendocrine tumours; pheochromocytomas, gangliomas and neuroblastomas

\*Symptoms of hyperviscosity syndrome: headaches, dizziness, syncope, tinnitus, diplopia, blurred vision, amaurosis, paraesthesia, mental fatigue, restless legs.

## TREATMENT

Patients with Eisenmenger syndrome should be followed by a dedicated congenital cardiology clinic having access to dedicated specialists and a multi-disciplinary team including psychological support<sup>34</sup>. While the definitive treatment for Eisenmenger syndrome remains closure of the shunt and lung transplantation or combined heart and lung transplantation, management has evolved over the last several decades from symptomatic treatment, many of which may have proven deleterious, to targeted therapies for pulmonary vasoactive disease<sup>35</sup>.

Pharmacological treatment historically involved digitalis, diuretics, anti-arrhythmics and anticoagulants, none of which significantly modified survival or risk of deterioration. With the recognition that many patients with Eisenmenger syndrome maintain some degree of pulmonary vasoreactivity, medical therapies (endothelin receptor antagonists; phosphodiesterase inhibitors; inhalational nitric oxide and prostacyclin; calcium channel blockers) aimed at reducing elevated pulmonary vascular resistance have been adopted from clinical experience in treating patients with pulmonary arterial hypertension. While controversial and associated with limited clinical evidence, these targeted therapies have even permitted correction of the underlying defect in selected patients<sup>36</sup>. Closure of the right-to-left communication has typically been contraindicated due to high mortality and poor outcome. However, where the pulmonary vascular modelling changes are responsive to treatment the so-called treat-and-repair strategy has been reported.

Pregnancy is generally considered contra-indicated with maternal mortality reportedly between 30-70 per cent<sup>37</sup>. There is no consensus as to the most appropriate method of birth control with the safety of hormone-based contraception questioned due to the potential prothrombotic effects. Progesterone containing contraceptives (pills, intra-uterine devices and implants) may also interact with endothelin receptor antagonists but are the preferred method<sup>34,38</sup>.

The use of supplemental oxygen therapy is controversial due to the variable and often limited vasodilator response of the pulmonary vasculature and is recommended only in situations where it produces a consistent increase in arterial oxygen saturation and improved clinical wellbeing. It does not improve survival. Chronic oxygen therapy may contribute to a drying effect on the nasal mucosal membrane and tracheobronchial tree contributing to increased risk of nocturnal cough, greater interference with sleep and potential risk for pulmonary haemorrhage<sup>39</sup>. High flow nasal oxygen (HFNO) is increasingly being used as part of ward, operating theatre and critical care therapy. Humidification allows for better clearance of secretions, preventing mucosal drying and decreased atelectasis reducing the risk of post-operative respiratory failure and morbidity from invasive ventilation<sup>40</sup>.

Erythrocytosis also causes iron-deficiency, particularly when combined with therapeutic phlebotomy. While previously common practice, chronic phlebotomy should not be performed routinely or in asymptomatic or mildly symptomatic individuals. Hyperviscosity syndrome usually is evident with a haemoglobin level above 20mg/dL and haematocrit exceeding 65 per cent<sup>41</sup>. Phlebotomy with isovolaemic replacement by removal of 250-500ml of blood over an hour while infusing 750ml to 1000ml of saline is usually performed for patients with moderate or severe symptoms of hyperviscosity, including headache, tinnitus, dizziness, paraesthesia, myalgia and poor concentration<sup>34</sup>. Routine phlebotomy can otherwise cause iron deficiency and the microcytic erythrocyte, being less deformable, induces higher viscosity than normocytic erythrocytes at comparable haematocrits<sup>40</sup>. Consideration can be made for preoperative phlebotomy for autologous blood donation if the haematocrit level is above 65 per cent<sup>34</sup>.

Targeted pharmacotherapies remain under-prescribed in Eisenmenger syndrome. These therapies offer improvements in exercise capacity, functional class haemodynamics, quality of life and sometimes survival<sup>42</sup>. Endothelin-receptor antagonists bosentan, sitaxsentan and ambrisentan are selective for the endothelin A receptor while macicentan is a dual antagonist for endothelin A and B receptors. Sildenafil and tadalafil are oral phosphodiesterase-5 inhibitors that augment the effects of nitric oxide by raising intracellular cyclic guanosine monophosphate levels. They have been associated with antiproliferative effects on vascular smooth muscle and improve contractility in the hypertrophied right ventricular myocardium. Targeting the prostacyclin pathway is difficult in patients with Eisenmenger syndrome. Intravenous administration carries the risks of infection, thrombosis and paradoxical emboli, nevertheless epoprostenol has been shown to exert favourable effects on haemodynamics. Selexipag, a novel oral prostacyclin analogue may be a promising agent<sup>43</sup>.

Vaccine strategies are recommended for the prevention of influenza and pneumococcal pneumonia and diuretics should be used for those showing signs of right heart failure with fluid retention. In one study, reports suggest that the presence of structural CHD did not necessarily increase the risk and morbidity from COVID-19 infections. Susceptibility to severe COVID-19 infection may be based on physiological factors, not the complexity of the underlying defect, and are concordant with general population studies showing increased risk for age, male sex, diabetes and renal insufficiency<sup>44</sup>. Recent studies have found that while COVID-19 mortality in most adults with congenital heart disease is commensurate with the general population and risk factors derived from the general population (age, overweight, diabetes, renal insufficiency and multiple comorbidities) are equally important for determining outcome, unrepaired cyanotic defects or patients with Eisenmenger syndrome define a subgroup at increased risk for complicated disease course defined as hospitalisation requiring ventilation, inotropic support or a fatal outcome<sup>72,73</sup>. Targeted preventative measures are indicated for these patients<sup>73</sup>.

In 2018 the American Heart Association/American College of Cardiology (AHA/ACC) introduced a classification system based on a combination of anatomical and physiological characteristics to stratify patient functional status and haemodynamic issues. The ACC recommends that patients at an advanced, decompensated physiological state (physiological stage C or D), considered the highest risk cardiac patients, be prioritised for vaccination<sup>45</sup>. There is no current evidence to suggest one vaccine is preferred over another despite the low risk of vaccine induced thrombocytopenia; however, The Australian Technical Advisory Group on Immunisation (ATAGI) currently recommends the Pfizer COVID-19 vaccine for adults aged 60 years or younger<sup>46</sup>.

## PREOPERATIVE CONSIDERATIONS

The perioperative mortality in this patient population is estimated at 4-18 per cent, therefore a multi-disciplinary approach to patient assessment must be undertaken to evaluate fitness for the proposed procedure. Preoperative evaluation should involve physicians experienced in these types of complex cases<sup>47</sup>. Where possible, surgeries should be limited to those essential procedures and performed in specialised centres by experienced clinicians. The risks and benefits of the procedure should be thoroughly considered; the risks of anaesthesia, surgery and post-operative recovery should be adequately communicated to the patient and or caregivers to allow appropriate informed consent<sup>48</sup>.

Preoperatively, an understanding should be attained of the type of cardiac defect, directionality of shunt flow, cardiac chamber affected, pulmonary artery pressures, resting oxygen saturation (SpO<sub>2</sub>), cardiac function and complications related to prior procedures<sup>49</sup>. Cardiac imaging including echocardiograms, which are mandated annually in patients suitably followed and MRIs should be pursued and reviewed. In the case of prolonged withdrawal due to procedural time a nasogastric tube can be used to dose pulmonary vasodilators intraoperatively. If enteral absorption is compromised a shift to intravenous prostanoid therapy may be necessary. Patients may also have an extensive transfusion history and an antibody screen with appropriate reservation of blood products is advised<sup>50</sup>. Antibiotic prophylaxis for surgical procedure guidelines should be followed respecting that unrepaired cyanotic defects are classified among the highest risk patients in current guidelines.

## ANAESTHETIC MANAGEMENT

The anaesthetic management of Eisenmenger syndrome has been extensively reviewed elsewhere<sup>1,49</sup>. The purpose of this section is to highlight the general principles of management and comment on newer technologies and techniques which may improve anaesthetic-related morbidity and mortality.

The key principle in anaesthetic management is to maintain the balance between systemic vascular resistance (SVR) and pulmonary vascular resistance (PVR)<sup>4</sup>. Factors that decrease SVR or increase PVR, such as hypovolemia, hypoxemia, hypercarbia, acidosis and sympathetic stimulation should be avoided<sup>51</sup>. Monitored anaesthetic care (MAC), described as a specific anaesthesia service for diagnostic or therapeutic procedures performed under local anaesthesia along with sedation and analgesia titrated to a level that preserves spontaneous breathing and airway reflexes<sup>52</sup>, is frequently considered due to a perception of increased safety; however one recent institutional experience reported 67 per cent of oxygen desaturations and both deaths encountered in their series occurring during MAC<sup>49</sup>.

Laparoscopic surgery poses the threats of increasing end-tidal carbon dioxide through peritoneal insufflation, increases in pulmonary artery pressure and limitations on ventilation with the possibility of gas embolisation<sup>53</sup>. Additional causes of decompensated heart failure may include high volume blood loss, exacerbation of pulmonary hypertension, right ventricular (RV) systolic dysfunction and venous air embolism (which could manifest as pulmonary embolus in an already strained RV), or paradoxical air embolus (PAE) entering the coronary or cerebral circulations. Blood loss can precipitate systemic arterial hypotension and increased right

to left shunting, leading to reduced oxygen delivery and impaired perfusion pressure to the right ventricle. The impact is compounded when faced with a higher demand on the ventricle from PAH worsened by hypoxaemia and acidaemia<sup>12</sup>.

Sympathetic blockade secondary to neuraxial anaesthesia may be hazardous due to the loss of preload and afterload. However, when neuraxial techniques have been employed, slow titration to facilitate a gradual onset is warranted, avoiding a sudden increase in right to left shunt via loss of systemic vascular resistance. Approaches described in the literature include incremental epidural top-up and spinal catheter. Spinal anaesthesia may result in a more reliable block, but a single shot approach is too haemodynamically unstable. The United States Food and Drug Administration (FDA) has previously withdrawn approval for the use of small-bore catheters for continuous spinal anaesthesia after several case reports of cauda equina syndrome. These were largely thought to be secondary to hyperbaric 5 per cent lidocaine (lignocaine) rather than the catheters per se. Larger epidural catheter may introduce an unacceptable incidence of post-dural puncture headaches. An alternative is “catheter over needle system” such as Braun spinocath<sup>54,55</sup>.

Meticulous attention should also be paid to eliminating the hazard of air embolus via infusion lines and in relation to the surgeon opening veins or venous sinuses with a patient in a position to allow air entrainment<sup>56</sup>. Alpha-adrenergic agents (phenylephrine, metaraminol) should be used to counteract the reduced SVR from anaesthetic agents. Ketamine, etomidate, dexmedetomidine or midazolam may be used as alternatives for minimising cardiovascular effects<sup>57</sup>. The use of dexmedetomidine and remifentanyl has previously been cautioned against in cases of pulmonary hypertension due to the deleterious combination of hypotension and bradycardia, especially with bolus dosing<sup>74</sup>. Attention to lung mechanics in order to avoid atelectasis and high intrathoracic pressures when using intermittent positive pressure ventilation is necessary to avoid deleterious effects on PVR<sup>58</sup>.

The role of invasive monitoring must be balanced against the increased complications from insertion, vascular damage, paradoxical embolisation, endocarditis and ventricular arrhythmias. Pulmonary artery catheters (PAC) pose the additional risk of pulmonary arterial rupture. In the case of a PAC, thermodilution determinations of cardiac output may be misleading due to the type and degree of shunt<sup>59</sup>.

Transtoesophageal echocardiography, as an emerging monitoring modality in noncardiac surgery, should be considered where equipment and expertise in obtaining and interpreting images exists.

Newer technologies including ClearSight® may be useful adjuncts to standard monitoring. ClearSight® is a non-invasive arterial blood pressure monitor based on two methods, the volume clamp method to continuously measure blood pressure and a physical method for initial and frequent calibration<sup>60</sup>. In a study involving 400 structural cardiology procedures involving continuous haemodynamic monitoring it was found that although the technology resulted in slight differences relative to current, commercially available, invasive approaches the bias was found to be clinically acceptable. Both invasive and non-invasive approaches were found to have the same percentage error when compared to cardiac output measurements from catheter-based techniques. However, limited clinical experience has been reported for its use in CHD to date<sup>61,62</sup>.

## INVESTIGATIONS

Non-invasive haemoglobin (Hb) was found to be unreliable compared to laboratory derived values in children with congenital heart disease and particularly in the cyanotic group with the error in co-oximetry derived Hb increasing as oxygen saturation decreases<sup>63</sup>. Caution is required for accurate measurement of coagulation parameters, haematocrit and blood glucose. When the haematocrit is above 55 per cent the citrate anticoagulant is excessive for the plasma fraction and will result in inaccuracy necessitating adjustment of the amount of anticoagulant to maintain an acceptable ratio<sup>34</sup>. Measurement of haematocrit via micro-haematocrit centrifugation results in plasma trapping and falsely raised values requiring use of automated electronic particle counts. Finally, blood glucose measurement can be falsely lowered by the high red blood cell metabolic activity unless a fluoride tube is used.

## PREGNANCY

Major hazards encountered by the pregnant patient with Eisenmenger syndrome are increased metabolic and cardiac output demands, peripheral vasodilatation and high placental flow precipitating a fall in systemic pressure, and the heightened risk of thromboembolism to the pulmonary or systemic circulation. Other risks include increased blood volume and decreased haematocrit due to pregnancy. The greatest risk occurs peripartum where large volume shifts and exhaustion of cardiac reserve combine for the highest risk of cardiopulmonary decompensation and death. The desire to utilise uninterrupted pharmacologic thromboembolism prophylaxis has led to some reports advocating for avoidance of central neuraxial blockade

however epidural anaesthesia facilitates the primary goals of a short labour, and avoidance of strenuous expulsive efforts (forceps or vacuum-assisted delivery) leaving the parturient free from pain, anxiety and sympathetic stimulation. The recommended mode of delivery is vaginally with a higher risk of death for caesarean section<sup>64</sup>.

Avoidance of uterotonic (for example, oxytocin) bolus dosing has been advised due to the risk of changes in SVR, while misoprostol and carboprost should be avoided because of pulmonary vasoconstriction. Many reported cases utilise a slow intravenous infusion of oxytocin post-partum to ameliorate the vasodilatory effect<sup>65,66</sup>. Considerations also include the timing and place of delivery with some reports advocating for the use of a cardiac operating theatre in high-risk cases due to the increased familiarity of staff with monitoring equipment and drugs utilised. This is obviously not practical in many centres. Close collaboration with obstetric and paediatric colleagues should dictate the timing of delivery with inductions at early gestations of 33 weeks considered when the risk of allowing the pregnancy to continue can outweigh the risk of prematurity or prolonged labour<sup>67,68</sup>.

Both veno-venous (V-V) and veno-arterial (V-A) extracorporeal membrane oxygenation (ECMO) has been described with satisfactory results in pregnant Eisenmenger patients<sup>69</sup>. Interestingly, due to the reversal of the shunt, oxygenated blood in a V-V ECMO circuit is directly introduced to the systemic circulation, which in the case of pregnancy can maximise foetal oxygenation.

## PHARMACOLOGICAL ALTERATIONS

Haemodynamic alterations in Eisenmenger syndrome can cause variable pharmacokinetic effects in several important anaesthetic drugs. Right-to-left shunting may prolong inhalational induction time particularly for relatively insoluble agents and intravenous induction may be hastened due to these agents bypassing the lungs<sup>5</sup>. As blood is shunted past the lungs, this not only decreases arm-brain circulation time but removes the potential binding of drugs to the pulmonary endothelium. This pulmonary extraction normally buffers the rate of drug rise for certain substances and may lead to increased fraction in the systemic circulation<sup>29</sup>.

This effect is seen with some local anaesthetics, opioids such as fentanyl and to a lesser extent, intravenous anaesthetics propofol and thiopental. Pulmonary extraction of lignocaine is in the order of 50 per cent and should be considered in the context of intravenous administration and maximum doses. Other local anaesthetics are effected to a lesser extent with prilocaine (40 per cent), mepivacaine (20 per cent) and bupivacaine (12 per cent) demonstrating reduced pulmonary first-pass extraction ratios<sup>29</sup>.

With respect to opioids, pulmonary uptake of fentanyl is great and in the vicinity of 75 per cent and the disappearance from the lungs biexponential with half-lives of 0.22 and 5.78 minutes. This is seen less with alfentanil which has a pulmonary extraction ratio of only 10 per cent and even less for morphine which is limited at 4-7 per cent during loading and steady-state conditions. The first pass pulmonary retention of a single dose of propofol is 28 per cent while thiopental has a first-pass retention of half this at 14 per cent. Coupled with the reduced arm-brain circulation time, caution should be exercised in the administration of propofol in the presence of a significant right-to-left shunt<sup>70</sup>. There is no substantial pulmonary uptake of muscle relaxants<sup>70</sup>.

## POSTOPERATIVE CONSIDERATIONS

Postoperative considerations include venous thromboembolism prophylaxis in the form of mechanical devices, compression stockings and early ambulation; the appreciation and the management of postoperative thrombotic and bleeding diatheses; and meticulous attention to fluid balance, sepsis or inflammatory responses, particularly to avoid postural hypotension and secondary increase in right to left shunting. Cautious use of analgesia precipitating hypoventilation and a decrease in afterload should be exercised with a low threshold for observation in an intensive care or high dependency unit setting for patients with a heightened opioid analgesic requirements<sup>71</sup>.

Cardiology consultation for management of pulmonary vasodilator therapy should be sought in the event of prolonged interruption of administration such as periods of invasive ventilation or a postoperative ileus with consideration of intravenous agents (for example, sildenafil) or inhaled nitric oxide. Oxygen saturations and blood pressure targets post-operatively should be maintained at the patient's usual resting values preoperatively with a suitable environment for monitoring if instability is expected.

## CONCLUSION

While becoming increasingly rare in high income countries due to increased rates of detection and treatment of abnormal or persistent circulatory communications, Eisenmenger syndrome remains a regular and risky dilemma for elective and emergent anaesthetic care. An understanding of the condition, an awareness of the anticipated disruptions, and the principles underlying maintenance of the perturbed cardiovascular physiology assist in promoting successful perioperative management.

## REFERENCES

- Galan Gutierrez JC, Fernandez Suarez FE, Miranda Garcia P, Sopena Zubiria LA. Anaesthetic management of breast surgery in a patient with Eisenmenger syndrome. *Rev Esp Anestesiol Reanim*. 2017; 64(1):41-5.
- The New York Times. Baron Eisenmenger, court physician, dead; medical adviser to late archduke Francis Ferdinand and ex-emperor Charles. *The New York Times United States* 1932.
- Eisenmenger V. Die angeborenen Defecte d. Kammerscheidewand d. Herzens 1897.
- Martin JT, Tautz TJ, Antognini JF. Safety of regional anesthesia in Eisenmenger's syndrome. *Regional Anesthesia & Pain Medicine*. 2002; 27(5):509-13.
- Foster JM, Jones RM. The anaesthetic management of the Eisenmenger syndrome. *Ann R Coll Surg Engl*. 1984; 66(5):353-5.
- Bartlett YK, Haywood A, Bentley CL, Parker J, Hawley MS, Mountain GA, et al. The smart personalised self-management system for congestive heart failure: Results of a realist evaluation. 2014; 14:109.
- Kempny A, Hjortshoj CS, Gu H, Li W, Opatowsky AR, Landzberg MJ, et al. Predictors of death in contemporary adult patients with Eisenmenger syndrome: A multicenter study. *Circulation*. 2017; 135(15):1432-40.
- Galie N, Manes A, Palazzini M, Negro L, Marinelli A, Gambetti S, et al. Management of pulmonary arterial hypertension associated with congenital systemic-to-pulmonary shunts and Eisenmenger's syndrome. *Drugs*. 2008; 68(8):1049-66.
- Mulder BJ. Changing demographics of pulmonary arterial hypertension in congenital heart disease. *Eur Respir Rev*. 2010; 19(118):308-13.
- Puri GD, Pradhan A, Kumar B, Hegde HV, Singh A, Prasad GRV. Anaesthetic management of a patient with Eisenmenger syndrome for lower abdominal surgery. *Trends in Anaesthesia and Critical Care*. 2011; 1(1):51-3.
- Kansaria JJ, Salvi VS. Eisenmenger syndrome in pregnancy. *J Postgrad Med*. 2000; 46(2):101-3.
- Heifets BD, Crawford E, Jackson E, Brodt J, Jaffe RA, Burbridge MA. Case report of an awake craniotomy in a patient with Eisenmenger syndrome. *A A Pract*. 2018; 10(9):219-22.
- Lovell AT. Anaesthetic implications of grown-up congenital heart disease. *Br J Anaesth*. 2004; 93(1):129-39.
- Galie N, Humbert M, Vachiery JL, Gibbs S, Lang I, Torbicki A, et al. 2015 ESC/ERS guidelines for the diagnosis and treatment of pulmonary hypertension: The joint task force for the diagnosis and treatment of pulmonary hypertension of the European Society of Cardiology (ESC) and the European Respiratory Society (ERS); Endorsed by: Association for European Paediatric and Congenital Cardiology (AEPC), International Society for Heart and Lung Transplantation (ISHLT). *Eur Heart J*. 2016; 37(1):67-119.
- Kaemmerer H, Mebus S, Schulze-Neick I, Eicken A, Trindade PT, Hager A, et al. The adult patient with Eisenmenger syndrome: A medical update after Dana Point Part I: Epidemiology, clinical aspects and diagnostic options. *Current Cardiology Reviews*. 2010; 6(4):343-55.
- Wood P. The Eisenmenger syndrome or pulmonary hypertension with reversed central shunt. *British Medical Journal*. 1958; 2(5099):755-62.
- Huang J-B, Liang J, Zhou L-Y. Eisenmenger syndrome: Not always inoperable. *Respiratory Care*. 2012; 57(9):1488-95.
- Lange RA, Brickner ME. Improving survival in patients with Eisenmenger syndrome: Are we any closer? *Circulation*. 2017; 135(15):1441-3.
- Bonnet S, Provencher S. Shear stress maladaptation in pulmonary arterial hypertension. An ageless concept. *Am J Respir Crit Care Med*. 2016; 193(12):1331-2.
- Adatia I, Kothari SS, Feinstein JA. Pulmonary hypertension associated with congenital heart disease. *Chest*. 2010; 137(6):52S-61S.
- Heath D, Edwards JE. The pathology of hypertensive pulmonary vascular disease; a description of six grades of structural changes in the pulmonary arteries with special reference to congenital cardiac septal defects. *Circulation*. 1958; 18(4 Part 1):533-47.
- Dimopoulos K, Inuzuka R, Goletto S, Giannakoulas G, Swan L, Wort SJ, et al. Improved survival among patients with Eisenmenger syndrome receiving advanced therapy for pulmonary arterial hypertension. *Circulation*. 2010; 121(1):20-5.
- Moceri P, Dimopoulos K, Liodakis E, Germanakis I, Kempny A, Diller GP, et al. Echocardiographic predictors of outcome in Eisenmenger syndrome. *Circulation*. 2012; 126(12):1461-8.
- Humbert M, Guignabert C, Bonnet S, Dorfmueller P, Klinger JR, Nicolls MR, et al. Pathology and pathobiology of pulmonary hypertension: State of the art and research perspectives. *European Respiratory Journal*. 2018; 1801887.
- Mehta PK, Simpson L, Lee EK, Lyle TA, McConnell ME, Book WM. Endothelin receptor antagonists improve exercise tolerance and oxygen saturations in patients with Eisenmenger syndrome and congenital heart defects. *Texas Heart Institute Journal*. 2008; 35(3):256-61.
- Chiriac A, Riley DC, Russell M, Moore JP, Padmanabhan D, Hodge DO, et al. Determinants of sudden cardiac death in adult patients with Eisenmenger syndrome. *J Am Heart Assoc*. 2020; 9(6):e014554.
- Bowater SE, Weaver RA, Beadle RM, Frenneaux MP, Marshall JM, Clift PF. Assessment of the physiological adaptations to chronic hypoxemia in Eisenmenger syndrome. *Congenit Heart Dis*. 2016; 11(4):341-7.

28. Remková A, Šimková I, Valkovicová T, Kaldarárová M. Platelet abnormalities in adults with severe pulmonary arterial hypertension related to congenital heart defects (eisenmenger syndrome). *Blood Coagulation & Fibrinolysis*. 2016; 27(8).
29. Joseph D, Puttaswamy RK, Krowidi H. Non-respiratory functions of the lung. *Continuing Education in Anaesthesia Critical Care & Pain*. 2013; 13(3):98-102.
30. Attar H, Sachdeva A, Sundararajan S. Cardioembolic stroke in adults with a history of congenital heart disease. *Stroke*. 2016; 47(5):e79-81.
31. Dimopoulos K, Diller GP, Koltzida E, Pijuan-Domenech A, Papadopoulou SA, Babu-Narayan SV, et al. Prevalence, predictors, and prognostic value of renal dysfunction in adults with congenital heart disease. *Circulation*. 2008; 117(18):2320-8.
32. Shiina Y, Toyoda T, Kawasoe Y, Tateno S, Shirai T, Matsuo K, et al. The prevalence and risk factors for cholelithiasis and asymptomatic gallstones in adults with congenital heart disease. *International journal of cardiology*. 2011; 152:171-6.
33. Chaix MA, Gatzoulis MA, Diller GP, Khairy P, Oechslin EN. Eisenmenger syndrome: A multisystem disorder-do not destabilize the balanced but fragile physiology. *Can J Cardiol*. 2019; 35(12):1664-74.
34. Oechslin E, Mebus S, Schulze-Neick I, Niwa K, Trindade PT, Eicken A, et al. The adult patient with eisenmenger syndrome: A medical update after dana point part iii: Specific management and surgical aspects. *Current cardiology reviews*. 2010; 6(4):363-72.
35. Nashat H, Kempny A, McCabe C, Price LC, Harries C, Alonso-Gonzalez R, et al. Eisenmenger syndrome: Current perspectives. *Research Reports in Clinical Cardiology*. 2017; Volume 8:1-12.
36. Kim M, Chung W-J. Current therapy of eisenmenger syndrome. *Journal of thoracic disease*. 2016; 8(11):3009-11.
37. Yuan SM. Eisenmenger syndrome in pregnancy. *Braz J Cardiovasc Surg*. 2016; 31(4):325-9.
38. Abarbanel G, Tepper NK, Farr SL. Safety of contraceptive use among women with congenital heart disease: A systematic review. *Congenital heart disease*. 2019; 14(3):331-40.
39. Sandoval J, Aguirre JS, Pulido T, Martinez-Guerra ML, Santos E, Alvarado P, et al. Nocturnal oxygen therapy in patients with the eisenmenger syndrome. *Am J Respir Crit Care Med*. 2001; 164(9):1682-7.
40. Gupta B, Kerai S, Kakkar K, Gupta L. Role of high-flow nasal oxygen therapy in cases with pulmonary hypertension in an intensive care unit setting. *Indian journal of critical care medicine : peer-reviewed, official publication of Indian Society of Critical Care Medicine*. 2019; 23(10):458-61.
41. DeFilippis AP, Law K, Curtin S, Eckman JR. Blood is thicker than water: The management of hyperviscosity in adults with cyanotic heart disease. *Cardiol Rev*. 2007; 15(1):31-4.
42. Diller GP, Alonso-Gonzalez R, Dimopoulos K, Alvarez-Barredo M, Koo C, Kempny A, et al. Disease targeting therapies in patients with eisenmenger syndrome: Response to treatment and long-term efficiency. *Int J Cardiol*. 2013; 167(3):840-7.
43. Ivy D, Wilson N. Tale of 2 endothelin receptor antagonists in eisenmenger syndrome. *Circulation*. 2019; 139(1):64-6.
44. Broberg CS, Kovacs AH, Sadeghi S, Rosenbaum MS, Lewis MJ, Carazo MR, et al. Covid-19 in adults with congenital heart disease. *J Am Coll Cardiol*. 2021; 77(13):1644-55.
45. Awerback J, Lantin-Hermossa R, Saidi A. Covid-19 vaccination in adults with congenital heart disease [Internet]. 2021.
46. Department of Health. About the astrazeneca covid-19 vaccine [Internet]. 2021. Available from: <https://www.health.gov.au/initiatives-and-programs/covid-19-vaccines/learn-about-covid-19-vaccines/about-the-astrazeneca-covid-19-vaccine>.
47. Das BB. Perioperative care of children with eisenmenger syndrome undergoing non-cardiac surgery. *Pediatr Cardiol*. 2015; 36(6):1120-8.
48. Motiani P, Chhabra V, Ahmad Z, Sharma PK, Gupta A. Risk recognition and multidisciplinary approach for non-cardiac surgeries in paediatric cardiac patients: A retrospective observational study. *Cureus*. 2020; 12(12):e12030.
49. Bennett JM, Ehrenfeld JM, Markham L, Eagle SS. Anesthetic management and outcomes for patients with pulmonary hypertension and intracardiac shunts and eisenmenger syndrome: A review of institutional experience. *J Clin Anesth*. 2014; 26(4):286-93.
50. Auluck A, Pai KM, Bhat KS, Thoppil PS. Unusual post-extraction hemorrhage in a cardiac patient: A case report. *J Can Dent Assoc*. 2004; 70(11):769-73.
51. Baum VC, Perloff JK. Anesthetic implications of adults with congenital heart disease. *Anesth Analg*. 1993; 76(6):1342-58.
52. Das S, Ghosh S. Monitored anesthesia care: An overview. *J Anaesthesiol Clin Pharmacol*. 2015; 31(1):27-9.
53. Sammut MS, Paes ML. Anaesthesia for laparoscopic cholecystectomy in a patient with eisenmenger's syndrome. *Br J Anaesth*. 1997; 79(6):810-2.
54. Cole PJ, Cross MH, Dresner M. Incremental spinal anaesthesia for elective caesarean section in a patient with eisenmenger's syndrome. *BJA: British Journal of Anaesthesia*. 2001; 86(5):723-6.
55. GHA. Spinocath® – the safe, successful and simple system for continuous spinal anesthesia (csa) [Internet]. 2021. Available from: <https://gha.health/en/produkt/spinocath-the-safe-successful-and-simple-system-for-continuous-spinal-anesthesia-csa/>.
56. Saxena A. Total intravenous anaesthesia in a patient with eisenmenger syndrome: Case report. *Journal of Anesthesia & Clinical Research*. 2012; 03(10).
57. Goyal R, Singh S, Bangi A, Singh SK. Case series: Dexmedetomidine and ketamine for anesthesia in patients with uncorrected congenital cyanotic heart disease presenting for non-cardiac surgery. *Journal of anaesthesiology, clinical pharmacology*. 2013; 29(4):543-6.
58. Saito K, Toyama H, Ejima Y, Yamauchi M. Preoperative assessment of the impact of positive pressure ventilation with noninvasive positive pressure ventilation in a patient with eisenmenger syndrome: A case study. *A A Case Rep*. 2016; 7(9):193-5.
59. Hoepfer MM, Maier R, Tongers J, Niedermeyer J, Hohfeld JM, Hamm M, et al. Determination of cardiac output by the fick method, thermodilution, and acetylene rebreathing in pulmonary hypertension. *Am J Respir Crit Care Med*. 1999; 160(2):535-41.

60. Edwards. ClearSight system. Noninvasive haemodynamic monitoring. [Internet]. Edwards Lifesciences Corporation.; 2021. Available from: <https://www.edwards.com/gb/devices/Hemodynamic-Monitoring/clearsight>.
61. Gellert G, Bramlage P. Use of the ClearSight® system for continuous noninvasive hemodynamic monitoring during heart valve interventions: Review of the literature and single-site experience. *Heart Surg Forum*. 2018; 21(6):E476-e83.
62. Yokose M, Mihara T, Takaya M, Yamamoto T, Saigusa Y, Takaki S, et al. The perfusion index measured by the pulse oximeter affects the agreement between ClearSight and the arterial catheter-based blood pressures: A prospective observational study. *PLoS One*. 2019; 14(7):e0219511-e.
63. Kamel MM, Hasanin A, Nawar B, Mostafa M, Jacob VF, Elhadi H, et al. Evaluation of noninvasive hemoglobin monitoring in children with congenital heart diseases. *Pediatric Anesthesia*. 2020; 30(5):571-6.
64. Mishra L, Pani N, Samantaray R, Nayak K. Eisenmenger's syndrome in pregnancy: Use of epidural anesthesia and analgesia for elective cesarean section. *Journal of anaesthesiology, clinical pharmacology*. 2014; 30(3):425-6.
65. Gurumurthy T, Hegde R, Mohandas B. Anaesthesia for a patient with Eisenmenger's syndrome undergoing caesarean section. *Indian journal of anaesthesia*. 2012; 56(3):291-4.
66. Lopez BM, Malhame I, Davies LK, Gonzalez Velez JM, Marelli A, Rabai F. Eisenmenger syndrome in pregnancy: A management conundrum. *J Cardiothorac Vasc Anesth*. 2020; 34(10):2813-22.
67. Avila WS, Grinberg M, Snitcowsky R, Faccioli R, Da Luz PL, Bellotti G, et al. Maternal and fetal outcome in pregnant women with Eisenmenger's syndrome. *Eur Heart J*. 1995; 16(4):460-4.
68. Katsurahgi S, Kamiya C, Yamanaka K, Neki R, Miyoshi T, Iwanaga N, et al. Maternal and fetal outcomes in pregnancy complicated with Eisenmenger syndrome. *Taiwanese Journal of Obstetrics and Gynecology*. 2019; 58(2):183-7.
69. Agerstrand C, Abrams D, Biscotti M, Moroz L, Rosenzweig EB, D'Alton M, et al. Extracorporeal membrane oxygenation for cardiopulmonary failure during pregnancy and postpartum. *The Annals of Thoracic Surgery*. 2016; 102(3):774-9.
70. Boer F. Drug handling by the lungs. *Br J Anaesth*. 2003; 91(1):50-60.
71. Price LC, Alonso-Gonzalez R, Alexander D, Dimopoulos K. Intensive care of the adult with congenital heart disease. Cham: Springer International Publishing; 2019. Critical care management of the adult with Eisenmenger syndrome and pulmonary arterial hypertension related to congenital heart disease; p. 273-97.
72. Schwerzmann M, Ruperti-Repilado J, Baumgartner H, Bouma B, Bouchardy J, Budts W, et al. Clinical outcome of COVID-19 in patients with adult congenital heart disease. *Heart*. 2021; 107: 1226-1232.
73. Broberg CS, Kovacs AH, Sadeghi S, et al. COVID-19 in Adults with congenital heart disease. *J Am Coll Cardiol*. 2021; 77: 1644-1655.
74. Smith I. Pulmonary Hypertension: an overview for the non-cardiac anaesthetist. *Australasian Anaesthesia*. 2015: 75-82.



## Right ventricular failure – when the right heart goes wrong

### Richella-Lea Falland MBBS FANZCA MCLinEd

**Cardiothoracic Anaesthesia Fellow, Greenlane Department of Cardiothoracic and ORL Anaesthesia, and Cardiothoracic and Vascular Intensive Care Unit, Auckland City Hospital, New Zealand**

Dr Richella-Lea Falland graduated from the University of Adelaide and completed her training in anaesthesia in hospitals throughout South Australia. She is currently undertaking a one-year fellowship in cardiothoracic anaesthesia and intensive care at Auckland City Hospital. She has developing interests in cardiothoracic and vascular anaesthesia, transoesophageal echocardiography and the management of complex cardiac patients presenting for non-cardiac surgery.

### Kate Drummond MBBS FANZCA MMed

**Senior Staff Specialist, Royal Adelaide Hospital, South Australia, Specialist Anaesthetist, Pulse Anaesthetics, Adelaide, South Australia, and Clinical Senior Lecturer, University of Adelaide Medical School, Faculty of Health and Medical Sciences, Adelaide, South Australia**

Dr Kate Drummond is a staff specialist anaesthetist at the Royal Adelaide Hospital and works in private practice with Pulse Anaesthetics. She has a master's degree in perioperative medicine and her special areas of interest include perioperative blood management with a focus on blood conservation, cardiothoracic anaesthesia and transoesophageal echocardiography.

### Nicole Wylie MBBS FANZCA MMed

**Staff Specialist Paediatric Anaesthetist, Women's and Children's Hospital, South Australia, Clinical Lecturer, University of Adelaide Medical School, Faculty of Health and Medical Sciences, Adelaide, South Australia**

Dr Nicole Wylie works as a staff specialist at the Women's and Children's Hospital in Adelaide, South Australia. Her practice is primarily in paediatric anaesthesia with a special interest in anaesthesia for congenital heart disease. She also has an interest in pharmacology and undertakes research in this area in the paediatric population.

## INTRODUCTION

The importance of the right ventricle (RV) was first recognised in 1616, when it was described by Sir William Harvey. However, investigation of the RV remained overshadowed by the study of the left ventricle (LV) until the mid-20th century when cardiac surgeons began to recognise the importance of right-sided heart function in open heart surgery<sup>1</sup>. These early endeavours to explore the RV expanded into the fields of cardiology, critical care medicine, and perioperative medicine. The sum of those efforts characterises what we now know about how the RV plays a pivotal and active role in the passage of blood from the venous system to the pulmonary system. Despite substantial advances in knowledge, significant limitations remain in our knowledge of how to manage patients who present with RV dysfunction.

Right heart failure has been defined as “a clinical syndrome [that arises] due to an alteration of structure and/or function of the right heart circulatory system [and] leads to suboptimal delivery of blood flow (high or low) to the pulmonary circulation, and/or elevated venous pressures – at rest or with exercise<sup>2</sup>”. This article reviews the anatomy of the RV and the pathophysiology of RV failure. The assessment and management of this lesser-known form of heart failure will be discussed with an emphasis on the perioperative period for patients undergoing non-cardiac surgery.

## ANATOMY AND PHYSIOLOGY

The RV is the most anterior chamber of the heart. Lying immediately behind the sternum, it is distinct from the LV in terms of its function, physiology and anatomy. It is a thin walled, low-pressure chamber which acts to maintain pulmonary perfusion pressure and to deliver deoxygenated-mixed venous blood to the pulmonary vasculature for gas exchange. It also maintains low systemic venous pressure which prevents systemic organ congestion.

Structurally, it differs from the LV both macroscopically and microscopically. Macroscopically, the RV consists of a thin free wall (2-3mm thick at end diastole) and the interventricular septum (see Figure 1). There are three significant anatomical components: the *inlet*, consisting of the tricuspid valve, chordae tendinae and papillary muscles; the trabeculated *apical myocardium*; and the infundibulum or *conus*, the smooth myocardial outflow region<sup>3</sup>. When viewed in a longitudinal cross section, the RV appears triangular, whereas in a transverse cross-section it has a crescent shape (see Figure 1<sup>2,3</sup>).

**Figure 1. Shape of RV demonstrating relationship to LV in cross-section both longitudinally and transversely**

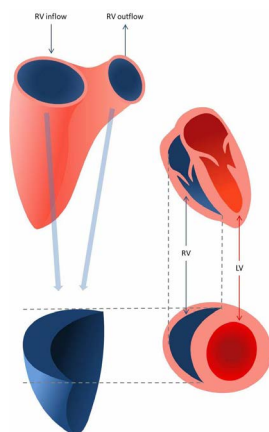

Microscopically, the RV's myofibril architecture is also unique. The superficial layer of myofibrils is oriented circumferentially, parallel to the atrioventricular groove, and in continuity with the LV. Deeper layers are oriented longitudinally from apex to base<sup>2,4</sup>. In contrast, the LV myofibrils are predominantly arranged circumferentially in a helical pattern.

Pulmonary perfusion is achieved by RV contraction and ejection. There are three separate actions that produce RV contraction. Firstly, the ventricular free wall moves inwards in a bellows-like movement; secondly, longitudinal fibre contraction of the deep myofibril layers draws the tricuspid annulus towards the apex; and thirdly, by LV contraction causing traction on the RV free wall<sup>5</sup>. Ejection occurs in a "peristaltic" manner that starts in the inflow tract and moves towards the outflow tract with free wall surface area being reduced primarily by the shortening of the longitudinal fibres. This differs significantly from LV contraction, which is caused primarily by activation of the circumferential fibres.

Venous return to the right atrium is facilitated by a gradient between the mean systemic filling pressure (MSFP) of the peripheral vasculature (normally 7-10mmHg), and that of the right atrial pressure (RAP) and central venous pressure (CVP) (normally 0mmHg)<sup>6</sup>.

Due to an earlier peak, and then rapid decline in pressure, the RV pressure-volume loop is more triangular than that of the LV. It also has poorly defined periods of isovolumetric contraction and relaxation (see Figure 2). Isovolumetric contraction time is comparatively short as the PV opens early – when the RV pressure exceeds the lower pulmonary artery (PA) pressure. Isovolumetric relaxation is almost absent as blood ejects from the RV into the PA throughout this phase, due to the forward movement of the blood in the low-pressure pulmonary system (see Figure 2<sup>7</sup>). In the healthy heart, RV filling starts before, and finishes after, that of the LV.

**Figure 2. Pressure volume loop of RV compared with LV**

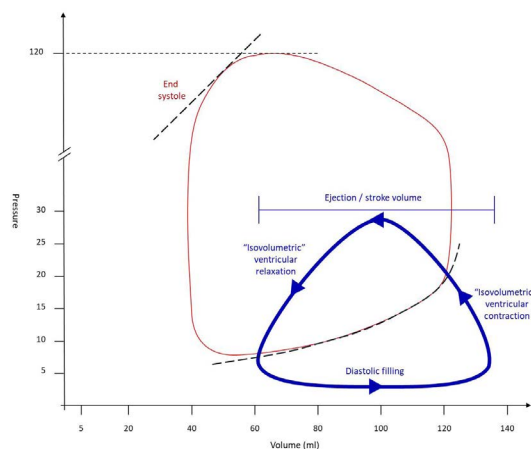

Perfusion of the RV is predominantly via the right coronary artery (RCA) and its branches. In 80 per cent of the population the coronary circulation is "right dominant". In these cases, the RCA also supplies the inferior wall of the LV as well as the posterior third of the interventricular septum, via the posterior descending artery (PDA) branch. The other 20 per cent of the population has a "left dominant" circulation, wherein the PDA branch arises from the left coronary artery (LCA). In patients with a left dominant circulation, the RCA supplies the RV only and LV perfusion is completely independent of this vessel.

Perfusion of the RV via the coronary arteries occurs throughout both diastole and systole due to the lower pressures observed in the right heart chambers<sup>9</sup>. This contrasts with LV perfusion, which occurs primarily in diastole due to the higher pressures in LV systole and contraction. The lower pressures mean RV stroke work is only 25 per cent of that of the LV, despite the RV ejecting the same cardiac output. RV oxygen demand is also correspondingly lower<sup>9</sup>.

The overall function of the RV is influenced by preload, afterload, and contractility, as well as by pericardial restriction, heart rhythm, and interaction with the left ventricle<sup>9</sup>. The initial RV response to changes in preload or afterload is well described by the Frank-Starling mechanism, with increasing cardiac output achieved by escalating contractility in response to greater myocardial stretch<sup>10,11</sup>. In the presence of persistent higher loading conditions, the RV is subject to the Anrep effect (slow-flow effect). In this situation, over 10-15 minutes of sustained increase in stretch, inotropy continuously rises due to an increase in calcium responsiveness within the myofilament<sup>12</sup>. The Starling curve of the RV is flatter than that of the LV and consequently there is a lower variation of RV contractility over a wide range of filling pressures<sup>13</sup>. This means the RV can tolerate a wider and higher range of preload conditions before it fails.

## PATHOPHYSIOLOGY OF RIGHT HEART DYSFUNCTION

RV dysfunction can occur due to pressure overload (increased afterload), volume overload (increased preload), or impaired myocardial contractility (see Table 1)<sup>14</sup>. Due to its structural characteristics and low muscle mass, a more compliant RV can typically tolerate increases in right-sided venous return (preload) but is less able to tolerate sudden increases in afterload<sup>15-17</sup>.

**Table 1. Causes of acute RV failure<sup>14</sup>**

Acute left ventricular failure
Right ventricular ischaemia/infarction
Acute pulmonary oedema
Chronic lung disease/hypoxia
Acute lung injury or respiratory distress syndrome
Sepsis
Chronic pulmonary hypertension
Pericardial disease
Arrhythmias
Congenital heart disease
Valvulopathies (tricuspid regurgitation; pulmonary stenosis)
Cardiomyopathies
Myocarditis
Cardiac surgery
Haematological disorders (for example, sickle cell syndrome)

### Effect of higher afterload

When RV afterload increases over a prolonged period, the RV responds with progressive hypertrophy and increasing contractility in order to try and maintain adequate cardiac output. A common cause of this is chronic pulmonary hypertension. However, when compensation mechanisms are exhausted, decompensation occurs (see Figure 3).

In contrast, acute increases in RV afterload result in the short-term RV compensation of increased end-diastolic volume (dilation) and contractility. This occurs in acute pulmonary thromboembolic events. However, acute compensations are often insufficient to maintain ejection from the thinner-walled, less-contractile RV in the face of the suddenly increased afterload. Thus, RV dysfunction can rapidly develop<sup>18</sup>. This can also occur in clinical situations when an otherwise healthy RV is required to acutely generate mean pressures exceeding 40mmHg.

**Figure 3. Pathophysiology of acute RV failure**

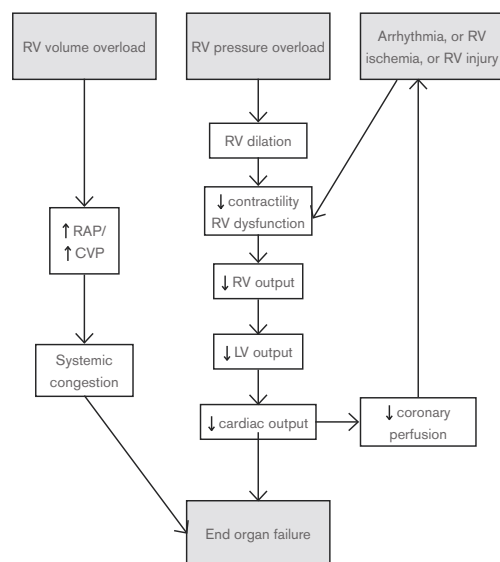

#### Effect of higher preload

Chronic RV volume overload eventually leads to RV dilation and heart failure. RV dilation can reduce LV preload in three ways. Firstly, the inability to generate sufficient pressure to eject blood through the pulmonary circulation limits left atrial filling. Secondly, an enlarging RV results in an elevated end-diastolic pressure that eventually exceeds LV end-diastolic pressure. This causes compression and/or lessening of LV filling and ejection. Thirdly, tricuspid annular dilation causes valvular regurgitation (TR) and, with each cardiac contraction, reduces forward flow through the pulmonary vasculature.

The now-dilated and higher-pressure RV chamber causes LV compression as the RV interventricular septum bulges into it. This creates a flattened (or D-shaped) septum, in a phenomenon known as ventricular interdependence, resulting in relative under filling of the LV. This distortion of the LV has harmful effects on the efficiency of LV contraction, which further contributes to a fall in cardiac output<sup>19-22</sup>.

#### Ischaemia

The dilated RV is at added risk of ischaemia and, with this, further impairment of contractility. Increased RV end-diastolic pressure impedes coronary blood flow due to a reduced perfusion gradient between the aortic root and the right heart chambers. Consequently, a dilated or distended RV is predisposed to hypotension-related ischaemia.

Furthermore, RV dysfunction causes increased right atrial pressures. This results in a decrease in systemic venous return which is secondary to a lower pressure gradient between the MSFP and RAP, thus precipitating a fall in systemic venous return<sup>21</sup>.

Ultimately, RV dysfunction, regardless of the underlying aetiology, will lead to the development of RV dilation (with subsequent TR), RV systolic and diastolic failure, and a fall in cardiac output of both ventricles causing systemic hypotension. End-organ hypo-perfusion, and systemic venous congestion eventually occur, with subsequent multi-organ dysfunction (see Figure 3<sup>6,9</sup>).

## ASSESSMENT OF THE RIGHT HEART

### Clinical assessment

The clinical manifestations of RV failure are non-specific, but it does cause signs of systemic venous congestion. Such signs include elevated jugular venous pressure, peripheral oedema, and/or a hepatojugular reflex. Signs of RV dysfunction can be present and include a third heart sound and/or a murmur of TR, as well as signs of a low cardiac output state which include hypotension, tachycardia, cool peripheries, or oliguria<sup>11,13</sup>. Biochemically, increased lactate, deranged liver biochemistry, and/or impaired renal function may represent evidence of liver congestion or end-organ hypo-perfusion from inadequate cardiac output.

An ECG may be normal; however, evidence of right axis deviation, right bundle branch block, and right ventricular hypertrophy may be present. The S1/Q3/T3 triad of RV strain may also be present in the form of a large S wave in lead I, a Q wave in lead III and an inverted T wave in lead III, especially if the underlying context is acute pulmonary embolism (PE) (up to 10 per cent of patients).

### Cardiac biomarkers

Elevated natriuretic peptides and cardiac troponin T are non-specific for right heart pathology. However, elevations in these biomarkers can correlate with reduced RV function after a PE when there is also pulmonary hypertension, or following congenital cardiac surgery. Currently, there are no RV-specific biomarkers available for clinical use; however, there is research in this area including in the use of these biomarkers for perioperative risk stratification in cardiac and non-cardiac surgery<sup>24,25</sup>. Early studies into the inflammatory biomarkers tumorigenicity 2/soluble ST2 (ST2/sST2) and galectin-3 (GT-3) have demonstrated a correlation with RV dysfunction in some disease-specific states, including pulmonary hypertension and mechanical support.

### Echocardiographic assessment

The anterior location of the right heart makes transthoracic echocardiography (TTE) an ideal modality to assess RV anatomy and function. Transoesophageal echocardiography (TOE) can also be useful; however, the distance from the probe to relevant structures and a poor Doppler alignment can limit TOE assessment. Importantly, qualitative assessment methods commonly used to assess the RV have only been validated for TTE.

The most used markers of RV function in TTE are tricuspid annular plane systolic excursion (TAPSE), fractional area change (FAC), and the myocardial performance (Tei) index. Other measures include tissue Doppler parameters and tricuspid regurgitant (TR) jet velocity. Often, these parameters are recorded on the TTE report, but little is mentioned about RV function in the report summary. As such, it is important for clinicians to have some basic understanding of the normal values for these parameters to make up their own mind.

TAPSE is a measure of how far the tricuspid annular plane moves downwards (longitudinally) towards the apex of the RV in systole and is an excellent indicator of free wall longitudinal contraction. As most RV contraction occurs via the longitudinal fibres, TAPSE offers a simple measure of RV function. However, this method assumes that displacement of the basal and adjacent segments is representative of function in other RV regions. A normal value is greater than 16mm<sup>26</sup>.

FAC is a useful measure of overall RV systolic function. Measured in a four-chamber view, it is calculated as the percentage change in area between systole and diastole. A FAC less than 35 per cent is indicative of RV systolic dysfunction<sup>26</sup>.

The Tei index is less commonly used. It is also known as the myocardial performance index (MPI). It is dimensionless and calculated as the sum of isovolumetric contraction time and isovolumetric relaxation time divided by the ejection time. It is a useful marker as it incorporates elements from both systolic and diastolic phases. However, the Tei index relies on a constant R-R interval, so is not useful in atrial fibrillation. Values are obtained using pulsed wave Doppler or tissue Doppler techniques. Normal values are less than 0.40 by pulsed Doppler and less than 0.55 by tissue Doppler<sup>26</sup>.

Tissue Doppler imaging (TDI) uses pulsed wave tissue Doppler and colour-coded tissue Doppler to measure the longitudinal velocity of excursion of certain regions of the RV in systole – most commonly the tricuspid annulus and the basal free wall segment. The systolic velocity is reported as S', with normal values varying by Doppler type and region. An S' less than 10cm/sec should raise suspicion for abnormal RV systolic function<sup>26</sup>.

Measurement of the velocity of TR jet, if present, permits estimation of RV systolic pressure (RVSP) and with the addition of RAP, this measure is equivalent to pulmonary artery systolic pressure (sPAP) in the absence of pulmonary stenosis.

Further review of RV structure and function can be performed using imaging of RV dimensions and geometry, septal positioning and motion, assessment of diastolic function, and strain assessment.

Pre-operative TTE assessment has been shown to predict preoperative cardiac complications in non-cardiac surgery. Lower TASPE and an increased Tei index have predictive value, whereas FAC, sPAP and tissue Doppler parameters do not<sup>27</sup>.

Bedside TTE or intraoperative TOE can be used to assess acute deterioration of RV function or in unexplained haemodynamic instability and to identify the underlying aetiology. Conditions affecting the RV that can be diagnosed or excluded include acute PE, cardiac tamponade, RV myocardial infarction, acute RV or LV dysfunction, and acute valvulopathies<sup>10</sup>.

### Cardiac MRI (CMR)

Due to the complex geometry of the RV, CMR is the most accurate non-invasive technique to assess the RV. Assessments can include RV mass, volume, and ejection fraction as well as scar burden, myocardial strain, and perfusion and pulmonary pulsatility. Normal RV ejection fractions (RVEF) are higher than LV ejection fractions as RV volumes are smaller. A higher percentage of end diastolic volume needs to be ejected to maintain the equivalent stroke volume and cardiac output. RVEF varies between 47-76<sup>28,29</sup>.

### Invasive haemodynamic assessment

Pulmonary artery catheters or right heart catheters can be used to assess RV failure when aetiology is unclear or there is treatment resistance. A pulmonary artery catheter (Swan-Ganz) can be “floated” at the bedside or otherwise inserted in the cardiac catheterisation laboratory while performing left heart catheterisation and coronary artery angiography. Accurate assessment of right and left atrial pressure, cardiac output, pulmonary artery pressures and resistance, and mixed venous oxygenation levels – SvO<sub>2</sub> (surrogate ScO<sub>2</sub>) – can also be determined<sup>11</sup>. While right heart catheter studies are the gold standard invasive assessment of the RV, the procedure is more invasive than echocardiography and is not without hazard<sup>27</sup>. Thus, pulmonary artery catheters are generally reserved for cases where the benefit of having the additional information they provide outweighs the risks involved.

## PERIOPERATIVE RIGHT HEART FAILURE

In critical care settings and during perioperative periods, right heart failure is most commonly due to an interaction between an “at risk” RV and an acute precipitating event. This results in decompensation by affecting preload, afterload or contractility, or a combination of all three<sup>10</sup>. An RV may be “at risk” due to chronic underlying dysfunction, or due to an acute pathophysiological process which has developed in the perioperative period.

In these circumstances, the aim of perioperative management is to identify patients early in the preoperative period who are at risk of RV failure, optimise their RV function prior to theatre, and avoid conditions which may precipitate deterioration in function. Less commonly, an acute perioperative event may occur, which results in rapid deterioration of a pre-morbidly, well-functioning RV.

Patients at particular perioperative risk of a deteriorating RV function include those with known elevations in pulmonary vascular resistance, valvulopathies (notably mitral or tricuspid valve disease), congenital heart disease, or ischaemic heart disease.

An understanding of how the RV handles challenges to preload and afterload can aid clinicians in managing patients in these situations. As the RV rarely manages acute afterload changes well, a failing RV can be supported with treatments that lower, or prevent significant rises in, afterload. And, where the healthy RV manages preload well, a failing RV may need contractile support to manage rapid or significantly increasing preload. Ischaemic RV dysfunction should be managed by optimising myocardial oxygen supply and demand.

## PERIOPERATIVE MANAGEMENT OF CHRONIC RIGHT HEART FAILURE OR THE RIGHT VENTRICLE AT RISK

### General principles

The management principles of patients at risk of perioperative RV dysfunction include identifying and treating reversible causes. Key concerns are controlling contributing factors (hypoxaemia, hypercapnia, anaemia, acidaemia, sepsis, arrhythmias), optimising fluid volume status, maintaining adequate RV perfusion pressure, maintaining positive inotropy, and using pulmonary vasodilators<sup>30</sup>.

High-risk procedures include those associated with venous air, CO<sub>2</sub>, fat, or cement embolism (including orthopaedic procedures and liver transplants). This is because these cause sudden increases in pulmonary vascular resistance and RV afterload<sup>31</sup>. Additionally, any procedure which requires rapid, large volume infusion increases the risk of RV dysfunction. Activation of the systemic inflammatory response system can also

lead to large volume shifts and RV impairment if there is a need for rapid fluid resuscitation<sup>32</sup>. Laparoscopic procedures require vigilance to the potential negative effects of a pneumoperitoneum on preload, lung volumes, hypercarbia, and acidosis. Awareness of patient positioning and the effects on ventilation and venous return are also important.

In patients with known elevations in pulmonary vascular resistance or RV dysfunction, all attempts should be made to optimise function prior to proceeding to surgery. This includes continuing, where possible, usual medications throughout the perioperative period.

### Monitoring

In addition to routine monitoring, further options are tailored to the patient and procedure being performed.

Invasive arterial pressure monitoring is recommended to allow early recognition and aggressive correction of systemic hypotension to prevent organ hypoperfusion<sup>32</sup>.

Inserting a central venous catheter should be considered as it can be used to provide inotropic support and measure CVP. While the efficacy of routine CVP monitoring in this group is controversial, CVP trends can guide management and treatment. This is especially the case in prolonged procedures or when large fluid shifts are anticipated<sup>29</sup>. Nevertheless, studies have demonstrated a limited relationship between CVP and intravascular volume status and there remains limited evidence for the reliability of CVP, or delta-CVP, in predicting the haemodynamic response to a fluid challenge<sup>33,34</sup>.

There may be multiple other roles for the use of CVP catheters. They can monitor for new tricuspid regurgitation (being the development of dominant v wave and sharp y descent) and can facilitate the measurement of mixed venous saturations as a marker of sufficiency of cardiac output. They can also be used when an increasing CVP may suggest acutely deteriorating RV function<sup>35</sup>.

A pulmonary artery catheter (PAC) allows direct monitoring of pulmonary artery pressures as well as the cardiac index and SvO<sub>2</sub>. Despite this, there is limited evidence for its routine use. Furthermore, its use has been associated with an increase in morbidity and mortality due to arrhythmias and pulmonary vessel damage. This is of particular concern when used in centres unaccustomed to their frequent placement.

Intraoperative TOE allows continuous direct assessment of RV contractility, RV dilation, and the interventricular septum. In the setting of acute deterioration, TOE can aid in identifying precipitating factors such as PE, and guide therapies aimed at optimising preload, afterload, and contractility.

Temperature monitoring and active warming should be used to avoid hypothermia-induced increases in pulmonary vascular resistance and myocardial oxygen demand associated with post-operative shivering.

### Anaesthetic technique

The choice of anaesthetic technique is secondary to careful and active conservation of haemodynamic homeostasis with meticulous attention to the management of preload, afterload, and contractility. In addition, pulmonary vascular resistance should be minimised, and RV coronary perfusion maintained. Regional, neuraxial, or general anaesthesia can be used. The choice should be determined by underlying and comorbid disease processes, clinician experience, and patient choice. If neuraxial techniques are employed, blockade should be introduced slowly. Adequate preparation is key in managing haemodynamic perturbations<sup>35</sup>.

All commonly used anaesthetic agents have potentially negative effects on RV function. Volatile anaesthetic agents reduce RV preload and contractility and can precipitate RV dysfunction. Nitrous oxide and desflurane are associated with increases in pulmonary vascular resistance and should be avoided in at risk patients. Etomidate has been advocated as the induction agent of choice as it has less effect on systemic vascular resistance, myocardial contractility, and pulmonary vascular resistance. However, it is not available for use in Australia but is available in New Zealand. Propofol and thiopentone are associated with reductions in RV contractility and systemic vascular resistance (SVR), but do not affect pulmonary vascular resistance (PVR). These agents can usually be safely used with appropriate dose adjustment<sup>31</sup>. Ketamine increases PVR in adult patients. This will increase RV afterload so large doses should be avoided in patients with known or at risk of RV failure.

Adequate use of neuromuscular blocking drugs (NMBDs) should be maintained throughout the case to optimise respiratory mechanics. However, ensuring adequate NMBD reversal prior to extubation is essential.

Opioids should be used judiciously, as large doses will blunt sympathetic tone. This may result in systemic hypotension and reduced RV contractility<sup>31</sup>. Additionally, opioid induced hypoventilation in the post-operative period may result in hypercarbia and associated increases in pulmonary vascular resistance. However, an important postoperative concern is adequate analgesia as this mitigates pain-related and sympathetically-mediated increases in PVR<sup>31</sup>. Non-opioid adjuncts and regional techniques can be used to aid this purpose.

## Induction

Adequate pre-oxygenation and gentle bag-mask ventilation will help avoid hypercarbia and hypoxia while at the same time will ensure intrathoracic pressure is not elevated. Ample sympathetic nervous system blunting is advisable. Typically this can be done by using opioids, an adequate depth of anaesthesia, and a complete neuromuscular blockade prior to airway manipulation. This helps mitigate increases in pulmonary vascular resistance induced by coughing or straining.

Throughout the induction period, the anaesthetist should have vasopressor agents immediately available to prevent or aggressively treat any post-induction hypotension.

## Mechanical ventilation strategies

The optimal ventilation strategy will avoid hypoxaemia, hypercarbia, and respiratory acidosis. When PaO<sub>2</sub> falls below 60mmHg, PVR worsens due to hypoxic pulmonary vasoconstriction (HPV). Hypercapnia increases pulmonary artery pressures by 1mmHg per 1mmHg increase in PaCO<sub>2</sub><sup>38</sup>. These factors can cause haemodynamically significant RV impairment<sup>39,40</sup>.

Both atelectasis and high lung volumes should be avoided. PVR will increase at low lung volumes, when collapse of extra-alveolar vessels and terminal airways cause alveolar hypoxia and HPV. At high lung volumes there is a stretch of the alveolar walls, which is transmitted to alveolar vessels and thus impedes forward blood flow. PVR is optimised when ventilation occurs at functional residual capacity (FRC)<sup>41</sup>. Additionally, systemic venous return is impeded when increased airway pressures in turn increase intrathoracic pressure.

Overall, recommendations for optimal ventilation techniques are to use lung protective strategies with tidal volumes of 6mL/kg and plateau pressures less than 30cmH<sub>2</sub>O. Oxygenation should be augmented by increasing FiO<sub>2</sub>. However, PEEP should not be increased any higher than 10cm H<sub>2</sub>O due to the risk of pre-load compromise<sup>32</sup>. Ultimately, using multiple adverse ventilation techniques at the same time may have negative effects on pulmonary vascular resistance<sup>36,37</sup>.

## Volume optimisation

The perioperative state can be characterised by rapid changes in intravascular volume because of bleeding and third space losses. Compounding this is a blunted sympathetic nervous system secondary to anaesthetic agents. This contributes to vasodilation, blood pooling and decreased venous return<sup>13</sup>.

Patients with RV dysfunction may be preload-dependent. However, excessive volume loading can precipitate RV over-distension and subsequently an increase in RV wall tension. If myocardial fibres become overstretched, a spiral into reduced RV contractility and ultimately reduced systemic cardiac output may occur<sup>13</sup>. To avoid unnecessary volume expansion, intravenous fluid therapy should be delivered cautiously and transfusion of red blood cells should be minimised unless significant anaemia develops<sup>18</sup>.

Given the above limitations of CVP monitoring, it can be difficult to assess whether a patient with RV dysfunction is likely to be fluid responsive. One approach to determining this is to assess the haemodynamic response to a passive straight leg raise of 45 degrees. If elevation of the legs produces a 2-5mmHg elevation in CVP and corrects mean arterial pressure, a fluid bolus would be indicated<sup>31</sup>. Alternatively, in patients with a CVP of less than 12mmHg, a fluid challenge of 250-500mL of intravenous crystalloid can be trialled<sup>18</sup>. In patients with a dilated RV, induced diuresis may be required for ventricular offloading and reduction in right-sided filling pressures<sup>37</sup>.

## Rate and rhythm

It is generally preferable to maintain a faster heart rate (80-100bpm) to prevent excessive RV distension, minimise LV distortion, and avoid worsening of TR. This will assist in maintaining adequate cardiac output<sup>31,37</sup>. These targets should be balanced against the risk of a rate-related increase in myocardial oxygen demand with subsequent exacerbation of an “at risk” RV.

The most common arrhythmias observed in patients with RV failure are atrial tachycardias. This is most likely due to dilation of the right atrium or to chronic remodelling. These are often poorly tolerated and the loss of atrial kick can precipitate haemodynamic instability. If not promptly corrected, arrhythmias can be associated with the development of cardiogenic shock<sup>18</sup>. New-onset atrial fibrillation, or flutter, has been associated with increased morbidity and mortality<sup>42</sup>. Ventricular tachycardia may also occur, most commonly in patients with RV ischaemia, congenital heart disease, and/or in patients who have previously had surgery involving their right ventricle.

Optimising electrolytes, especially potassium (K+) and magnesium (Mg2+) can reduce the rate of new arrhythmia development. Prompt direct current cardioversion (DCCV) is the treatment of choice for haemodynamic instability; however, the success of this technique may be limited in critical illnesses in restoring sinus rhythm and a controlled rate<sup>43</sup>.

Of the antiarrhythmic pharmacotherapies, amiodarone is the agent of choice. This is because beta-blocker therapy and calcium channel blockers reduce inotropy and may further impair RV function<sup>42,44</sup>.

## Vasopressor therapy

The primary aim of vasopressor administration in RV impaired states is to improve myocardial perfusion of the right ventricle. This may also have an additional effect in optimising interventricular function<sup>23,35</sup>. The ideal vasopressor increases SVR and either reduces or has no effect on PVR. However, the effects of vasopressor agents on the pulmonary vasculature are complex, and typically related to relative  $\alpha$  and  $\beta$  effects at different doses<sup>35</sup>.

Noradrenaline will increase coronary perfusion by increasing aortic root pressure. At high doses of >0.5 microg/kg/min, it can also increase PVR. For this reason, its use is usually limited to doses of <0.2microg/kg/min<sup>45</sup>. Phenylephrine can be used as an alternative agent, although it has also been associated with increases in PVR and worsening of RV function<sup>45,46</sup>. Vasopressin of 1-4units/min can be used where noradrenaline therapy has failed as it is not associated with increases in PVR. Indeed, at low doses vasopressin may be associated with a decrease in PVR<sup>45</sup>.

## Inotropic therapy

Inotropic agents including dobutamine, dopamine, adrenaline, levosimendan and phosphodiesterase 3 inhibitors (for example, milrinone) act to improve cardiac output by increasing myocardial contractility<sup>11</sup>.

Dobutamine, a beta agonist, is the most commonly used inotrope in RV failure. It is given typically at doses of 2-5 microg/kg/min at which it increases cardiac output while simultaneously decreasing pulmonary vascular resistance (PVR)<sup>47-49</sup>. It may also decrease SVR at the same time and thus require co-administration of a vasopressor agent<sup>45</sup>.

A low dose dopamine of <5 microg/kg/min has been shown to improve RV function in the setting of pulmonary vascular dysfunction; however, its use is limited by the potential for development of tachyarrhythmias<sup>45</sup>.

Milrinone, a phosphodiesterase-3 inhibitor, promotes myocardial contractility while simultaneously reducing RV afterload. Milrinone intravenous infusions of 0.25-0.5 microg/kg/min will reduce pulmonary artery pressures and augment RV function. However, this agent usually requires co-administration of a vasopressor agent<sup>45</sup>. Nebulised milrinone can be used in pulmonary hypertensive crises and has the advantage of pulmonary selectivity, resulting in less systemic hypotension<sup>50</sup>.

Levosimendan is a calcium sensitizer, acting via the troponin C receptor to optimise myocardium responsiveness to calcium. As well as selectively inhibiting PDE III weakly, it also acts on the ATP-sensitive sarcolemma K<sup>+</sup> channels of smooth muscle. The overall effects are to improve diastolic function and myocardial contractility without increasing myocardial oxygen demand and to induce ischaemic preconditioning; it also has multiple pleiotropic effects<sup>51</sup>. The benefits of a reduced PVR, increased RV efficiency, and improved RV-PA-coupling can last for several days through the actions of its active metabolite<sup>45,51</sup>. The actions of levosimendan are calcium-dependent and thus hypocalcaemia should be aggressively managed and corrected<sup>51</sup>. Its use in the acute perioperative setting is limited by its cost and the necessary administration via an IV infusion over a period of 24 hours.

Digoxin therapy, a single dose of 1mg, acutely improves cardiac output by 10 per cent in patients with RV failure without affecting heart rate<sup>52</sup>.

## Pulmonary vasodilator therapy

Intravenous pulmonary vasodilators are useful to reduce RV afterload as they mediate PVR which causes an increase the RV stroke volume. However, their administration can be complicated by systemic hypotension and hypoxaemia from ventilation-perfusion mismatch<sup>30</sup>. Therefore, these agents should be commenced after optimisation of RV perfusion. Evidence for their use is predominantly in the setting of chronic pulmonary hypertension, cardiac surgery (including heart transplantation) or in patients with mechanical cardiac support<sup>31,53</sup>.

Prostanoids act via increases in pulmonary vascular prostacyclin I<sub>2</sub> levels. They include intravenous epoprostenol, subcutaneous treprostinil, and nebulized iloprost. Endothelin (ET)-1 antagonists (bosentan), produce pulmonary vasodilation by inhibiting an endothelium-derived vasoconstrictor. Sildenafil (a phosphodiesterase-5 inhibitor) is available as an oral preparation.

Other agents associated with PVR reductions are calcium channel blockers, adenosine, magnesium, and glyceryltrinitrate (GTN); however, they are not routinely used for this purpose.

## Mechanical support

Mechanical supports include intra-aortic balloon pumps (IABPs), extracorporeal mechanical oxygenation (ECMO), and ventricular assist devices (VADs). These may be considered in specialist centres when severe

RV failure occurs due to a reversible cause, such as RV ischaemia or acute PE. The aim is to prevent multi-organ dysfunction by providing support until the RV recovers<sup>11</sup>. For many institutions around Australia and New Zealand, this may require transfer to a centre with experience in such techniques. Consideration must be given to provision of elective surgery in these patients with known RV failure in centres where this form of support can be given.

There are limited options for long-term RV mechanical support. Using ECMO is limited to days or weeks, and paracorporeal RVADs are only approved for use for one week. Using IABPs have been described for managing RV failure; however, they likely improve RV function by augmenting coronary flow rather than providing direct effects on the RV<sup>37,54</sup>.

#### Postoperative care

The increased risk to the RV associated with anaesthesia and surgery extends into the postoperative period as the postoperative period is likely the time of greatest risk of deterioration<sup>55</sup>. Patient factors, surgery duration and complexity, anticipated ongoing fluid shifts, hypoventilation, and vasopressor or inotropic requirements, dictate the level of postoperative care required. For many patients, the most appropriate ward for immediate postoperative management will be an intensive care or high dependency setting.

As in the operating theatre, avoiding atelectasis (with the addition of early chest physiotherapy in the postoperative setting), preventing hypoxia and hypercarbia, maintaining temperature management, and optimising analgesia is crucial in the postoperative period. Thromboprophylaxis should be started as soon as haemostasis is adequate to prevent the development of pulmonary thromboembolic disease.

### TREATMENT OF SPECIFIC CAUSES OF ACUTE INTRAOPERATIVE RIGHT HEART FAILURE

Acute right heart syndrome has been defined as “a rapidly progressive syndrome with systemic congestion resulting from impaired RV filling or reduced RV flow output”. It is associated with increased rates of morbidity and mortality<sup>11</sup>.

#### Acute pulmonary embolism

New onset RV failure is the primary determinant of early mortality in acute PE. A “high risk” or “massive” PE is clinically characterised by “persistent arterial hypotension or shock caused by overt RV failure”. Patients with intermediate risk are “normotensive patients with a high clinical prognostic score accompanied by imaging or biochemical markers of RV dysfunction”<sup>11</sup>. Normally, the RV can generate a mean pulmonary artery pressure of up to 40mmHg before RV stroke volume declines. Further to this, it requires 50-75 per cent of the pulmonary vasculature to be occluded by emboli before acute RV failure occurs<sup>14</sup>.

In patients with high-risk PEs, the recommended strategy is to achieve reperfusion using intravenous thrombolysis. However, in the perioperative period this may be contraindicated due to bleeding risk. Alternative therapies, including surgical pulmonary thrombectomy or interventional radiological approaches should be considered<sup>11</sup>. Surgical intervention is usually reserved for patients with an absolute contraindication to thrombolysis, whereas catheter-directed fibrinolysis or pharmaco-mechanical fibrinolysis are usually reserved for patients with a relative contra-indication<sup>56</sup>.

#### Right ventricular infarction

Proximal RCA occlusion causes acute inferior myocardial ischaemia and the RV is most at risk<sup>57</sup>. Up to 30-50 per cent of patients with this pathology will develop some degree of RV impairment. However, where reperfusion therapy is available, low cardiac output and severe hypotension are uncommon<sup>58</sup>. The lower oxygen demand of the RV, a superior oxygen extraction reserve capability, the frequent dual vascular supply found in the majority of patients, and increased rates of collateralisation in chronic ischaemic ventricles help protect the RV.

Treatment involves early myocardial reperfusion, preferably with primary percutaneous coronary intervention (PCI)<sup>59</sup>. Prior to revascularisation, the patient remains at risk of ventricular tachycardia, bradycardia requiring atropine, and a high-grade atrioventricular (AV) block requiring pacing. Nitrates and diuretics can compromise RV preload and should be avoided. Inotropic supports may be required<sup>11</sup>.

### CONCLUSION

Patients with active right heart dysfunction, or with an “at risk” RV, pose a unique set of challenges for the anaesthetist in the perioperative period. Failure of this often-overlooked ventricle results in significant morbidity and mortality and as such, its critical contribution in preserving systemic blood flow and organ perfusion should not be underestimated.

A thorough understanding of the physiology and pathophysiology of the RV can enable clinicians to identify patients at risk of RV dysfunction. This in turn can lead clinicians to optimise their patients’ preoperative condition, reduce their risk of peri-operative deterioration, and predict and therefore manage any acute decompensation of RV function.

### REFERENCES

- Harvey W, Leake CD. *Exercitatio anatomica de motu cordis et sanguinis in animalibus / by william harvey; an English translation with annotations by Chauncey D. Leake.* 3rd ed. Springfield, Ill: C.C. Thomas; 1941.
- Mehra MR, Park MH, Landzberg MJ, Lala A, Waxman AB. Right heart failure: Toward a common language. *Pulm Circ.* 2013; 3(4):963-7.
- Goor DA. Congenital malformations of the heart: Embryology, anatomy, and operative considerations / Daniel A. Goor, C. Walton Lillehei; Foreword by Owen H. Wangensteen; ill. by Albert Sway. Lillehei CW, editor. New York: Grune & Stratton; 1975.
- Ho SY, Nihoyannopoulos P. Anatomy, echocardiography, and normal right ventricular dimensions. *Heart (British Cardiac Society).* 2006; 92 Suppl 1(Suppl 1):i2-i13.
- Pappano AJ, Gil Wier W. *Cardiovascular physiology (10th ed).* Philadelphia: Elsevier; 2013. 4 - the cardiac pump; p. 55-90.
- Berlin D, Bakker J. Understanding venous return. *Intensive care medicine.* 2014; 40.
- Redington AN, Rigby ML, Shinebourne EA, Oldershaw PJ. Changes in the pressure-volume relation of the right ventricle when its loading conditions are modified. *Br Heart J.* 1990; 63(1):45-9.
- Murphy E, Shelley B. The right ventricle-structural and functional importance for anaesthesia and intensive care. *BJA Educ.* 2018; 18(8):239-45.
- Haddad F, Hunt SA, Rosenthal DN, Murphy DJ. Right ventricular function in cardiovascular disease, part i: Anatomy, physiology, aging, and functional assessment of the right ventricle. *Circulation.* 2008; 117(11):1436-48.
- Borgdorff MA, Bartelds B, Dickinson MG, Steendijk P, de Vroomen M, Berger RM. Distinct loading conditions reveal various patterns of right ventricular adaptation. *Am J Physiol Heart Circ Physiol.* 2013; 305(3):H354-64.
- Harjola VP, Mebazaa A, Čelutkienė J, Bettex D, Bueno H, Chioncel O, et al. Contemporary management of acute right ventricular failure: A statement from the heart failure association and the working group on pulmonary circulation and right ventricular function of the european society of cardiology. *Eur J Heart Fail.* 2016; 18(3):226-41.
- Cingolani HE, Pérez NG, Cingolani OH, Ennis IL. The anrep effect: 100 years later. *Am J Physiol Heart Circ Physiol.* 2013; 304(2):H175-82.
- Ventetuolo CE, Klinger JR. Management of acute right ventricular failure in the intensive care unit. *Ann Am Thorac Soc.* 2014; 11(5):811-22.
- Piazza G, Goldhaber SZ. The acutely decompensated right ventricle: Pathways for diagnosis and management. *Chest.* 2005; 128(3):1836-52.
- Naeije R, Brimiouille S, Dewachter L. Biomechanics of the right ventricle in health and disease (2013 grover conference series). *Pulm Circ.* 2014; 4(3):395-406.
- Hurford WE, Zapol WM. The right ventricle and critical illness: A review of anatomy, physiology, and clinical evaluation of its function. *Intensive Care Med.* 1988; 14 Suppl 2:448-57.
- Bartelds B, Borgdorff MA, Smit-van Oosten A, Takens J, Boersma B, Nederhoff MG, et al. Differential responses of the right ventricle to abnormal loading conditions in mice: Pressure vs. Volume load. *Eur J Heart Fail.* 2011; 13(12):1275-82.
- Haddad F, Doyle R, Murphy DJ, Hunt SA. Right ventricular function in cardiovascular disease, part ii: Pathophysiology, clinical importance, and management of right ventricular failure. *Circulation.* 2008; 117(13):1717-31.
- Taylor RR, Covell JW, Sonnenblick EH, Ross J, Jr. Dependence of ventricular distensibility on filling of the opposite ventricle. *Am J Physiol.* 1967; 213(3):711-8.
- Ama R, Leather HA, Segers P, Vandermeersch E, Wouters PF. Acute pulmonary hypertension causes depression of left ventricular contractility and relaxation. *Eur J Anaesthesiol.* 2006; 23(10):824-31.
- Visner MC, Arentzen CE, O'Connor MJ, Larson EV, Anderson RW. Alterations in left ventricular three-dimensional dynamic geometry and systolic function during acute right ventricular hypertension in the conscious dog. *Circulation.* 1983; 67(2):353-65.
- Goto Y, Slinker BK, LeWinter MM. Nonhomogeneous left ventricular regional shortening during acute right ventricular pressure overload. *Circ Res.* 1989; 65(1):43-54.
- Vlahakes GJ, Turley K, Hoffman JI. The pathophysiology of failure in acute right ventricular hypertension: Hemodynamic and biochemical correlations. *Circulation.* 1981; 63(1):87-95.
- Jabagi H, Mielniczuk LM, Liu PP, Ruel M, Sun LY. Biomarkers in the diagnosis, management, and prognostication of perioperative right ventricular failure in cardiac surgery-are we there yet? *J Clin Med.* 2019; 8(4).
- Jabagi H, Ruel M, Sun LY. Can biomarkers provide right ventricular-specific prognostication in the perioperative setting? *J Card Fail.* 2020; 26(9):776-80.
- Rudski LG, Lai WW, Afalalo J, Hua L, Handschumacher MD, Chandrasekaran K, et al. Guidelines for the echocardiographic assessment of the right heart in adults: A report from the american society of echocardiography endorsed by the european association of echocardiography, a registered branch of the european society of cardiology, and the canadian society of echocardiography. *J Am Soc Echocardiogr.* 2010; 23(7):685-713; quiz 86-8.
- Bolat I. Preoperative right ventricular echocardiographic parameters predict perioperative cardiovascular complications in patients undergoing non-cardiac surgery. *Heart Lung Circ.* 2020; 29(8):1146-51.
- Lorenz CH, Walker ES, Morgan VL, Klein SS, Graham TP, Jr. Normal human right and left ventricular mass, systolic function, and gender differences by cine magnetic resonance imaging. *J Cardiovasc Magn Reson.* 1999; 1(1):7-21.

29. Sanz J, Conroy J, Narula J. Imaging of the right ventricle. *Cardiology Clinics*. 2012; 30(2):189-203.
30. Zochios V, Jones N. Acute right heart syndrome in the critically ill patient. *Heart, lung and vessels*. 2014; 6:157-70.
31. Strumpher J, Jacobsohn E. Pulmonary hypertension and right ventricular dysfunction: Physiology and perioperative management. *J Cardiothorac Vasc Anesth*. 2011; 25(4):687-704.
32. Minai OA, Yared JP, Kaw R, Subramaniam K, Hill NS. Perioperative risk and management in patients with pulmonary hypertension. *Chest*. 2013; 144(1):329-40.
33. Marik PE, Baram M, Vahid B. Does central venous pressure predict fluid responsiveness?: A systematic review of the literature and the tale of seven mares. *Chest*. 2008; 134(1):172-8.
34. Marik PE, Cavallazzi R. Does the central venous pressure predict fluid responsiveness? An updated meta-analysis and a plea for some common sense\*. *Critical Care Medicine*. 2013; 41(7).
35. Forrest P. Anaesthesia and right ventricular failure. *Anaesth Intensive Care*. 2009; 37(3):370-85.
36. Lejeune P, Brimiouille S, Leeman M, Hallemans R, Melot C, Naeije R. Enhancement of hypoxic pulmonary vasoconstriction by metabolic acidosis in dogs. *Anesthesiology*. 1990; 73(2):256-64.
37. Murphy E, Shelley B. Clinical presentation and management of right ventricular dysfunction. *BJA Educ*. 2019; 19(6):183-90.
38. Balanos GM, Talbot NP, Dorrington KL, Robbins PA. Human pulmonary vascular response to 4 h of hypercapnia and hypocapnia measured using doppler echocardiography. *J Appl Physiol* (1985). 2003; 94(4):1543-51.
39. Mekontso Dessap A, Charron C, Devaquet J, Aboab J, Jardin F, Brochard L, et al. Impact of acute hypercapnia and augmented positive end-expiratory pressure on right ventricle function in severe acute respiratory distress syndrome. *Intensive Care Med*. 2009; 35(11):1850-8.
40. Moudgil R, Michelakis ED, Archer SL. Hypoxic pulmonary vasoconstriction. *J Appl Physiol* (1985). 2005; 98(1):390-403.
41. Lumb AB. *Nunn's applied respiratory physiology*. Eighth edition. ed. Edinburgh ;: Elsevier; 2016.
42. Arrigo M, Huber LC, Winnik S, Mikulicic F, Guidetti F, Frank M, et al. Right ventricular failure: Pathophysiology, diagnosis and treatment. *Cardiac failure review*. 2019; 5(3):140-6.
43. Arrigo M, Jaeger N, Seifert B, Spahn DR, Bettex D, Rudiger A. Disappointing success of electrical cardioversion for new-onset atrial fibrillation in cardiothoracic ICU patients. *Crit Care Med*. 2015; 43(11):2354-9.
44. Andersen S, Andersen A, de Man FS, Nielsen-Kudsk JE. Sympathetic nervous system activation and  $\beta$ -adrenoceptor blockade in right heart failure. *Eur J Heart Fail*. 2015; 17(4):358-66.
45. Price LC, Wort SJ, Finney SJ, Marino PS, Brett SJ. Pulmonary vascular and right ventricular dysfunction in adult critical care: Current and emerging options for management: A systematic literature review. *Crit Care*. 2010; 14(5):R169.
46. Rich S, Gubin S, Hart K. The effects of phenylephrine on right ventricular performance in patients with pulmonary hypertension. *Chest*. 1990; 98(5):1102-6.
47. Dell'Italia LJ, Starling MR, Blumhardt R, Lasher JC, O'Rourke RA. Comparative effects of volume loading, dobutamine, and nitroprusside in patients with predominant right ventricular infarction. *Circulation*. 1985; 72(6):1327-35.
48. Ferrario M, Poli A, Previtali M, Lanzarini L, Fétiveau R, Diotallevi P, et al. Hemodynamics of volume loading compared with dobutamine in severe right ventricular infarction. *Am J Cardiol*. 1994; 74(4):329-33.
49. Vizza CD, Rocca GD, Roma AD, Iacoboni C, Pierconti F, Venuta F, et al. Acute hemodynamic effects of inhaled nitric oxide, dobutamine and a combination of the two in patients with mild to moderate secondary pulmonary hypertension. *Crit Care*. 2001; 5(6):355-61.
50. Buckley MS, Feldman JP. Nebulized milrinone use in a pulmonary hypertensive crisis. *Pharmacotherapy*. 2007; 27(12):1763-6.
51. Pathak A, Lebrin M, Vaccaro A, Senard JM, Despas F. Pharmacology of levosimendan: Inotropic, vasodilatory and cardioprotective effects. *J Clin Pharm Ther*. 2013; 38(5):341-9.
52. Rich S, Seidlitz M, Dodin E, Osimani D, Judd D, Genthner D, et al. The short-term effects of digoxin in patients with right ventricular dysfunction from pulmonary hypertension. *Chest*. 1998; 114(3):787-92.
53. Trachte AL, Lobato EB, Urdaneta F, Hess PJ, Klodell CT, Martin TD, et al. Oral sildenafil reduces pulmonary hypertension after cardiac surgery. *Ann Thorac Surg*. 2005; 79(1):194-7; discussion -7.
54. Darrah WC, Sharpe MD, Guiraudon GM, Neal A. Intraaortic balloon counterpulsation improves right ventricular failure resulting from pressure overload. *Ann Thorac Surg*. 1997; 64(6):1718-23; discussion 23-4.
55. Aguirre MA, Lynch I, Hardman B. Perioperative management of pulmonary hypertension and right ventricular failure during noncardiac surgery. *Adv Anesth*. 2018; 36(1):201-30.
56. Guyton AC, Lindsey AW, Abernathy B, Richardson T. Venous return at various right atrial pressures and the normal venous return curve. *Am J Physiol*. 1957; 189(3):609-15.
57. Bowers TR, O'Neill WW, Pica M, Goldstein JA. Patterns of coronary compromise resulting in acute right ventricular ischemic dysfunction. *Circulation*. 2002; 106(9):1104-9.
58. Bueno H, López-Palop R, Pérez-David E, García-García J, López-Sendón JL, Delcán JL. Combined effect of age and right ventricular involvement on acute inferior myocardial infarction prognosis. *Circulation*. 1998; 98(17):1714-20.
59. Bowers TR, O'Neill WW, Grines C, Pica MC, Safian RD, Goldstein JA. Effect of reperfusion on biventricular function and survival after right ventricular infarction. *N Engl J Med*. 1998; 338(14):933-40.

## Management of right ventricular dysfunction after separation from cardiopulmonary bypass

**Mumtaz Khan, MBBS (hons), DipCU, FANZCA**

**Advanced PTeEXAM, Fiona Stanley Hospital, Perth, Western Australia**

Dr Mumtaz Khan is a consultant anaesthetist in Perth, specialising in cardiothoracic anaesthesia. He is a diplomate in advanced perioperative transoesophageal echocardiography from the National Board of Echocardiography USA.

**Michael Scerri, MBBS**

**Fiona Stanley Hospital, Perth, Western Australia**

Dr Michael Scerri is completing his ANZCA provisional fellowship in cardiothoracic anaesthesia, echocardiography and research.

### INTRODUCTION

Weaning from the mechanical circulatory support provided by cardiopulmonary bypass (CPB) is a challenging task for the anaesthetist, involving a high level of cognitive workload. Consideration of haemodynamic parameters, performing a transoesophageal echocardiogram (TOE) and communication with the surgeon and perfusionist all occur simultaneously. A challenging task becomes significantly more stressful if the function of the right ventricle (RV) starts to fail as separation from CPB occurs. This may lead to a precipitous spiral of hypotension, further RV dysfunction, progressing to poor left ventricular (LV) function and a decrease in systemic arterial pressure. Right heart failure is a major cause of morbidity and mortality in cardiac surgery and as such needs to be promptly recognised and managed<sup>1,2</sup>. This article will focus on the risk factors for the development of RV dysfunction following separation from CPB, how to diagnose it in a timely fashion and provide a suggested treatment strategy using a streamlined approach.

### FUNCTIONAL ANATOMY AND PHYSIOLOGY OF THE RIGHT VENTRICLE

When the RV fails it is unable to maintain adequate blood flow through the pulmonary circulation to achieve adequate LV filling<sup>3</sup>. The mechanisms by which the RV fails differs from the LV and is best appreciated by understanding the differences in anatomy. The RV has a thin free wall wrapped around the medial wall of the LV<sup>3,4</sup>. During systole, the RV contracts longitudinally from apex to base, whereas the LV contracts circumferentially<sup>3</sup>. As a result of these changes the more muscular LV is able to tolerate sudden changes in afterload better than the RV<sup>3</sup>. Conversely, moderate increases in preload are better tolerated by the RV as opposed to the LV<sup>3</sup>. When RV afterload increases, the RV dilates, reducing its contractility and hence its stroke volume<sup>3</sup>.

The RV is not only important for its function of pumping deoxygenated venous blood into the pulmonary circulation for gas exchange but also because changes in the RV function directly affect the LV and thus cardiac output and systemic blood pressure. This is known as ventricular interdependence. Ventricular interdependence describes how the size, shape and compliance of one ventricle affects the haemodynamic properties of the other<sup>5</sup>. The main determinants of ventricular interdependence are the interventricular septum, the pericardium, the shared blood supply and continuity of myocardial fibres between the RV and LV<sup>4,5</sup>.

Diastolic interdependence is primarily due to the pericardium; when the RV enlarges due to pressure or volume overload the intrapericardial pressure increases and shifts the interventricular septum to the left resulting in a decreased LV cavity size and stroke volume<sup>4</sup>. Systolic interdependence is mainly due to the interventricular septum<sup>4</sup>.

As is well known with the LV, the function of the RV is also affected by RV preload, afterload, contractility and rhythm. Preload is affected by the volume of blood in the systemic vasculature, heart rate, filling pressures of the LV, intrapericardial pressure and compliance of the RV<sup>4</sup>. Afterload is primarily determined by pulmonary vascular resistance. As previously described, the RV tolerates an increase in preload better than an increase in afterload.

### PREOPERATIVE ASSESSMENT OF RIGHT VENTRICULAR FUNCTION

Almost all patients booked for elective cardiac surgery will have a transthoracic and, or TOE preoperatively. Some patients will also have preoperative right heart catheterisation which will identify pressures of the right side of the heart including measurements of right atrial (RA) pressure, RV pressure, pulmonary artery (PA) pressure and pulmonary capillary wedge pressure (PCWP)<sup>6</sup>. RV dysfunction will likely be present if the RA pressure is greater than 8-10 mmHg, or RA pressure to PCWP index is greater than or equal to 0.8, and the

patient has a cardiac index of less than 2.2 L/min/m<sup>2</sup>. Of note, these measurements are in patients who are spontaneously ventilating and not sedated. RV outflow tract obstruction can hinder RV function and can be suspected when the RV to PA pressure gradient is more than 25 mmHg<sup>1</sup>.

## RISK FACTORS FOR DEVELOPING RIGHT VENTRICULAR DYSFUNCTION

Certain circumstances can place a patient at increased risk of developing post CPB RV failure. These include pre-existing RV dysfunction, pulmonary hypertension, long CPB times, left ventricular assist device (LVAD) insertion and heart transplantation, particularly where the donor heart has a long ischaemic time or mismatched in size<sup>2</sup>. In fact, RV failure post LVAD insertion has been estimated to occur in 20–40 per cent of cases, highlighting the necessity of quick identification and treatment<sup>3</sup>. Inadequate myocardial protection during CPB is also a risk factor for post bypass RV dysfunction<sup>2,4</sup>. Protection of the myocardium, while on CPB is provided via the delivery of cardioplegia, and often flooding of the surgical field with carbon dioxide<sup>5</sup>. Importantly, one of the well-known side effects of protamine administration is pulmonary hypertension, leading to an increase in RV afterload.

The blood supply to the RV is via the right coronary artery<sup>6</sup>. Any obstruction to blood flow through the right coronary artery post CPB will affect RV function. There are multiple triggers which can lead to this, with inadequate de-airing of the LV prior to coming off CPB being one of the most common aetiologies. The ostia of the right coronary artery is located anteriorly, and thus small air emboli are more prone to cause obstruction in this vessel. Other causes of decreased flow include failed grafting to the right sided circulation, suturing, damage or occlusion of the right coronary ostia during valve surgery and acute thrombus formation at the ostia or in the lumen of the right coronary artery<sup>7–9</sup>.

## PREVENTION

Management of the RV should be optimised in all patients to prevent dysfunction from developing. Firstly, arterial blood gas and ventilatory settings should be optimised to avoid pulmonary vasoconstriction. These include avoiding hypoxia by having a FiO<sub>2</sub> of 1.0, appropriate ventilator settings to avoid hypercarbia, excessive tidal volumes and PEEP and having a normal arterial pH as acidaemia increases pulmonary vascular resistance<sup>7</sup>.

Secondly, pulmonary vasodilators can be started in susceptible patients to manage afterload by decreasing pulmonary vascular tone prior to and after CPB. In our institution, we use inhaled nitric oxide (NO), delivered via the inspiratory limb of the anaesthetic circuit from a specific NO delivery system, with concentrations monitored and controlled in parts per million (ppm). This is generally commenced pre-CPB for patients with pre-existing RV dysfunction, pulmonary hypertension, LVAD insertion and heart transplantation, with a starting dose of 10–20 ppm, increasing to 40 ppm as required. Other options include inhaled milrinone and inhaled prostacyclines such as epoprostenol and iloprost. An advantage of iloprost is that it is easier to administer as it does not need to be given as a continuous infusion, unlike NO and epoprostenol<sup>7</sup>. Intravenous epoprostenol could potentially be used, but may cause bleeding due to its antiplatelet activity; this decrease of platelet aggregation is seen less with inhaled epoprostenol<sup>7</sup>.

Thirdly, it should be ensured that vigorous de-airing of the heart occurs prior to weaning off CPB, as air embolism is more common in the right sided coronary circulation, as already discussed. Carbon dioxide embolism, which may occur when carbon dioxide is used by the surgeons, appears to be less significant as it dissolves more rapidly than air<sup>10</sup>.

## TRANSOESOPHEGAL ECHOCARDIOGRAPHY ASSESSMENT OF RIGHT VENTRICULAR FUNCTION

The American Society of Echocardiography (ASE) released guidelines in 2010, updated in 2015, to assess RV function. Recommendations include the measurement of RV size, right atrial (RA) size, systolic PA pressure (with RA pressure estimated according to inferior vena cava dimensions) and a measure of RV systolic function utilising at least one of: fractional area change (FAC), tricuspid annulus peak velocity (S') or tricuspid annulus plane systolic excursion (TAPSE); with or without RV index of myocardial performance<sup>10,11</sup>. It is important to recognise that volumetric quantification of the RV is difficult and visual estimation to assess RV size and function is common<sup>10</sup>. Ejection fraction does not form part of the routine TOE examination of the RV.

The RV can be assessed through both mid oesophageal and transgastric views in both long and short axis<sup>12</sup>. The mid oesophageal views enable interrogation through the tricuspid valve to the RV apex allowing assessment of the apical portion of the anterior RV free wall<sup>15</sup>. In the deep transgastric position, a good representation of the RV inferior wall (in the near field) can be achieved, with anteflexion of the probe developing a view of the RV inflow tract and pulmonary valve<sup>14,15</sup>.

The RA should also form part of the RV functional assessment and is best visualised in the mid oesophageal four chamber view, mid oesophageal RV inflow-outflow view and the bicaval view. Similarly, the pulmonary valve and pulmonary arteries should be interrogated and are best viewed in the mid oesophageal RV inflow-outflow view (pulmonary valve) and upper oesophageal views (pulmonary arteries)<sup>12</sup>. Doppler assessments can be used to assess pulmonary flow characteristics<sup>12</sup>.

**Figure 1. TOE views that allow assessment of the RV**  
Reproduced with permission from Haddad et al<sup>1</sup>.

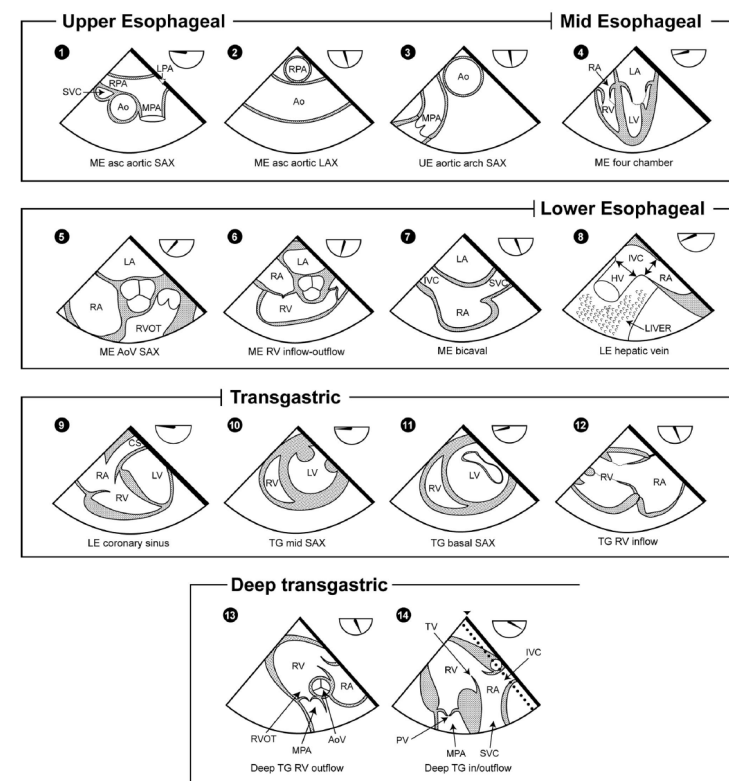

Upper oesophageal (UE), mid oesophageal (ME), low oesophageal (LE), transgastric (TG), deep TG. Asc=ascending; Ao=aorta; AoV= aortic valve; CS=coronary sinus; IVC=inferior vena cava; LA=left atrium; LAX=long axis; LPA=left pulmonary artery; LV=left ventricle; MPA=main pulmonary artery; PV=pulmonic valve; RA=right atrium; RPA=right pulmonary artery; RV=right ventricle; RVOT=right ventricular outflow tract; SAX=short axis; SVC=superior vena cava; TV=tricuspid valve.

A comprehensive intraoperative TOE assessment of the RV when weaning from CPB is not feasible, thus a focused exam needs to be performed. We would suggest assessment of the RV free wall, septal wall, RV inflow tract, RV outflow tract and assessment of TAPSE<sup>14,15</sup>. Below is a summarised table of abnormal values when assessing RV function via transthoracic echo which are used as a surrogate for TOE measures.



**Table 1. Abnormal RV parameters**Reproduced with permission from Rudski et al<sup>10</sup> and Lang et al<sup>11</sup>.

VARIABLE	UNIT	ABNORMAL
<b>CHAMBER DIMENSIONS</b>		
RV Basal diameter	cm	>4.1
RV mid diameter	cm	>3.5
RV free wall thickness	cm	>0.5
RV end diastolic volume (females)	ml/m <sup>2</sup>	> 74
RV end diastolic volume (males)	ml/m <sup>2</sup>	> 84
RV end systolic volume (females)	ml/m <sup>2</sup>	>36
RV end systolic volume (males)	ml/m <sup>2</sup>	>44
RA major diameter	cm	>5.3
RA minor diameter	cm	>4.4
RA end systolic area	cm <sup>2</sup>	>18
<b>SYSTOLIC FUNCTION</b>		
TAPSE	cm	<1.7
Pulsed doppler peak tricuspid annulus velocity	cm/s	<9.5
Pulsed doppler MPI		>0.43
Tissue doppler MPI		>0.54
FAC	%	<35
Ejection fraction	%	<45
<b>DIASTOLIC FUNCTION</b>		
E/A ratio		<0.8 or >2.0
E/e' ratio		>6
Deceleration time	ms	<120 or >242
<b>OTHER</b>		
RA pressure	mmHg	> 5
Tricuspid Regurgitation Velocity	m/s	>2.8
SPAP	mmHg	> 35
Longitudinal RV free wall strain	%	> -20

A tricuspid regurgitation velocity of 2.8m/s correlates to a SPAP of 36 mmHg, if assuming a RAP of 3-5mmHg.

RV=Right ventricle; RA=right atrium; TAPSE=tricuspid annulus plane systolic excursion; MPI=myocardial performance index; FAC=fractional area change; SPAP=systolic pulmonary artery pressure.

## TOE FINDINGS DURING RIGHT VENTRICULAR FAILURE

Due to asymmetry of the RV and reduced total muscle mass, it is difficult to diagnose subtle wall changes; akinesia or dyskinesia is often required to confidently diagnose an abnormality<sup>13</sup>. There is no consensus on the perfect index of RV function and in the authors' experience the most useful views to rapidly assess for RV dysfunction are the mid oesophageal four chamber view and RV inflow-outflow view to analyse TAPSE. Placing colour flow doppler across the tricuspid valve to identify any new or worsening tricuspid regurgitation is also recommended, as acute RV dilatation may result in tricuspid annular dilatation and disrupted leaflet coaptation<sup>7</sup>.

Other features on TOE that may indicate RV failure include:

- Evidence of raised of RA pressure (increased size, bowing of the inter-atrial septum to the left and dilated inferior vena cava with reduced collapsibility)<sup>10</sup>.
- An increase in the RV to LV size ratio >0.6<sup>12</sup>.
- A flattened or left sided deviation of the interventricular septum, which is usually positioned convex towards the RV<sup>13</sup>.

TAPSE is the most commonly and easily performed measurement post-CPB. However, its use along with the use of S' needs thoughtful consideration, as CPB and chest closure has been shown to lead to a decrease in these measurements<sup>17</sup>.

## IDENTIFICATION OF RIGHT VENTRICULAR FAILURE

As yet there is no proposed consensus definition of perioperative RV dysfunction<sup>14</sup>. In clinical practice a combination of TOE findings, haemodynamic parameters and visually inspecting the heart are used to identify the development of RV dysfunction intraoperatively<sup>15</sup>.

Haemodynamic parameters used to assess RV function are the central venous pressure (CVP) as a surrogate for RA pressure and use of a pulmonary artery catheter for PA pressures, PCWP and cardiac index. Findings suggestive of RV dysfunction are a CVP greater than 20 mmHg, the CVP being greater than the PCWP, with a cardiac index of less than 2.1 l/min/m<sup>2</sup><sup>15</sup>. A CVP wave form with fused c and v waves implies new tricuspid regurgitation and a failing RV<sup>16</sup>.

PA pressure monitoring via a pulmonary artery catheter remains the gold standard for monitoring critically ill cardiac patients and identifying pulmonary hypertension. As the RV progressively fails, the PA pressure falls because the ventricle is unable to generate pressure<sup>17,18</sup>. Scrutinising the RV pressure wave form is a technique described by Raymond et al as another powerful tool to identify RV dysfunction<sup>14</sup>. Continuous RV pressure curve monitoring is achieved by transducing the RV port of a pulmonary artery catheter, if one is present. RV diastolic pressure monitoring is a direct reflection of RV function and allows evaluation of RV outflow tract obstruction<sup>14</sup> (see Figure 2).

**Figure 2. Types of RV pressure (Prv) waveforms**

Reproduced with permission from Raymond et al<sup>14</sup>.

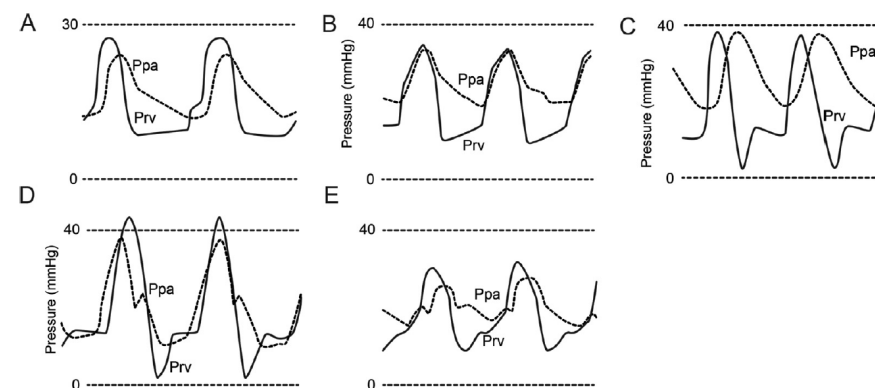

(A) Normal. (B) Mildly abnormal Prv waveform with an oblique diastolic slope >4 mmHg. There is a continuous gradient between the diastolic Prv and the diastolic pulmonary artery pressure (Ppa). (C) Abnormal Prv with a square-root sign. (D) As right ventricular function deteriorates, the diastolic gradient between the Prv and Ppa waveforms gradually will be reduced and can equalise. (E) Late stage of right ventricular systolic and diastolic failure with reduced dp/dt and pulsus tardus of the Prv in addition to the square root sign and diastolic pressure equalisation.

In a normal RV, the diastolic slope of the RV pressure waveform is almost horizontal. As RV dysfunction occurs the wave will begin to upslope. As RV function deteriorates further, the wave takes on a square root shape and then finally there is equalisation of diastolic RV and diastolic PA pressures<sup>14,15</sup>. With severe systolic RV failure, the systolic upstroke will be delayed and the RV pulse pressure will reduce<sup>19</sup>. Having the PA and RV pressure waveforms overlapping each other on the monitor screen can also assist with the identification of RV tract

outflow obstruction. RV to PA pressure gradient greater than 25 mmHg is indicative of either direct or dynamic outflow tract obstruction<sup>14,15</sup>. Figure 3 demonstrates this phenomenon.

**Figure 3. RV outflow tract obstruction in a patient exposed to milrinone**  
Reproduced with permission from Denault et al<sup>19</sup>.

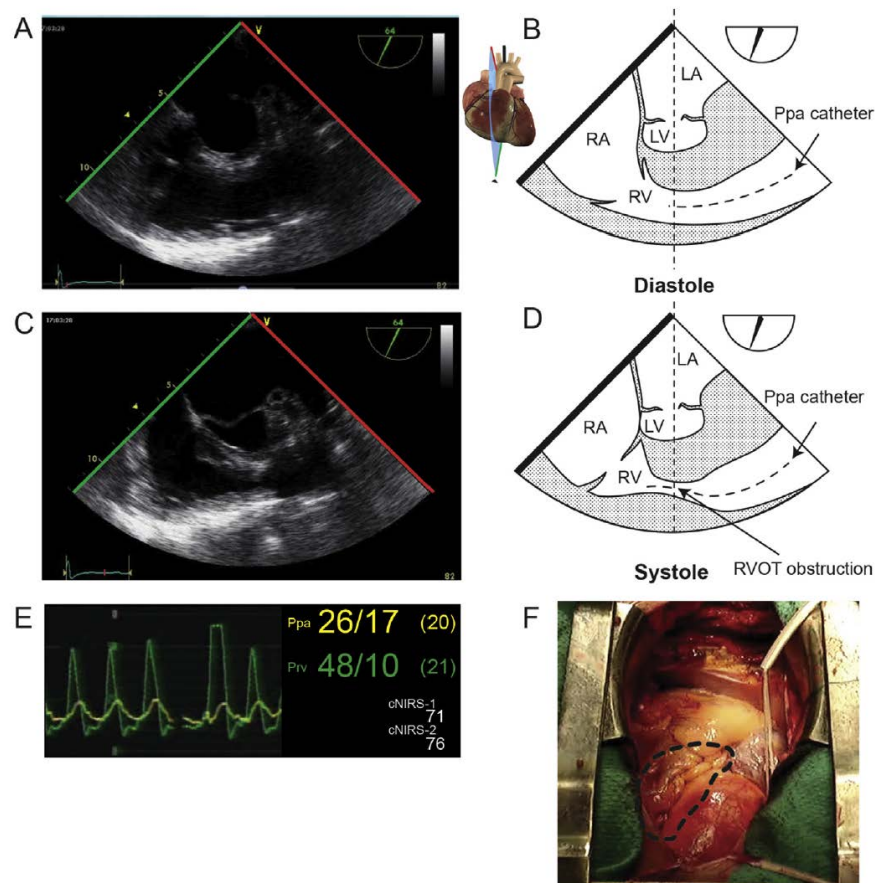

Mid oesophageal inflow-outflow views (A, B) in diastole and (C, D) in systole. Note the significant collapse of the right ventricular outflow tract (RVOT) during systole. (E) A 22 mmHg pressure gradient is noted using combined systolic right ventricular pressure (Prv) and systolic pulmonary artery pressure (Ppa) waveforms. (F) Intraoperative view of the RVOT systolic collapse. cNIRS=cerebral near infrared spectroscopy; LA=left atrium; LV=left ventricle; RA=right atrium; RV=right ventricle.

Pulmonary Artery Pulsatility Index (PAPi) is a new measure beginning to gain acceptance in the assessment of RV dysfunction, in particular during the management of patients post RV infarction, advanced heart failure, cardiogenic shock and LVAD implantation<sup>20</sup>. It is calculated by the formula:

$$\text{PAPi} = (\text{Systolic pulmonary artery pressure} - \text{diastolic pulmonary artery pressure}) / \text{right atrial pressure}$$

It is appreciated that the derivatives of the PAPi calculation are important factors in assessing RV dysfunction<sup>20</sup>. However, there is debate as to whether a single threshold can be applied to a heterogeneous population of patients, or whether specific values of PAPi are applicable only within a given population; reference values derived from numerous investigators appear to be wide and disease specific which means a single specified threshold value has not yet been established<sup>20</sup>.

## TREATMENT OPTIONS

When the RV fails, maintenance of haemodynamic stability depends on LV contraction, atrial contraction, atrioventricular synchrony and perfusion of the RV<sup>2</sup>, and these components must be addressed in order to improve the failing RV.

### Right ventricular preload

The volume requirements of the RV will differ depending on the degree of RV afterload<sup>3</sup>. In the setting of normal afterload, fluid loading will assist with maintaining RV stroke volume<sup>21</sup>. If afterload is raised, volume loading can result in the leftward displacement of the RV; ventricular interdependence will come into play, and an environment of reduced LV filling and stroke volume will develop<sup>3,15</sup>. When weaning off CPB, the CVP and PCWP can assist in deciding appropriate fluid management in conjunction with TOE and direct visualisation. If right sided filling pressures are low, as indicated by a CVP of less than 15 mmHg and a non-dilated RV on TOE, then judicious volume loading should be performed, being mindful not to overload the ventricle<sup>2</sup>. If RV preload is determined to be elevated, preload can be reduced by encouraging venous blood pooling by raising the head of the operating table or starting a GTN infusion to dilate venous capacitance vessels. An effective way to reduce preload is by asking the perfusionist to remove blood into the bypass circuit via the aortic cannula. It is also important to maintain sinus rhythm and treat any high degree atrioventricular block with pacing to reduce worsening haemodynamic function<sup>22</sup>. Where a RV is hypertrophied and non-compliant in the setting of pulmonary hypertension, maintenance of adequate systolic function relies heavily on atrial contraction<sup>7</sup>. Thus, atrial epicardial leads should be placed in the patient who has developed post CPB RV failure or considered in the patient who is at risk of developing RV failure in the postoperative setting<sup>2</sup>. Conversion to sinus rhythm by electrical or chemical means should be prioritised as supraventricular arrhythmias are poorly tolerated<sup>7</sup>.

### Right ventricular afterload

Pulmonary vascular resistance can increase after separation from CPB because of atelectasis, reperfusion injury, endothelial damage and the release of inflammatory mediators<sup>7</sup>. Before weaning from CPB any physiological parameters that can increase pulmonary vascular resistance should be identified and treated. To reiterate these include avoiding hypoxia by having a FiO<sub>2</sub> of 1.0, appropriate ventilator settings to avoid hypercarbia, avoiding excessive tidal volumes and PEEP and having arterial pH within the normal range<sup>3,6,23</sup>. Gentle ventilatory recruitment to promote parenchymal lung blood vessel opening is also beneficial.

Inhaled pulmonary vasodilators are the treatment of choice to decrease RV afterload, once ventilatory and physiological parameters have been addressed. Options available for inhaled pulmonary vasodilators are the same as those for preventative treatment: NO, prostacyclin, iloprost and inhaled milrinone. Inhaled NO is the most commonly used intraoperatively in our institution. It is integrated into the anaesthetic machine circuit preoperatively in patients with risk factors for RV dysfunction and can be mobilised easily if unexpected RV dysfunction develops. Inhaled drugs have the advantage of reducing pulmonary vascular resistance with less systemic hypotension and increases in ventilation-perfusion mismatch<sup>2</sup>.

### Right ventricular contractility

Decreased RV contractility in acute RV failure occurs because of overstretching of the RV free wall myocytes which reduces the contractile force that can be developed. These contractile forces are further hindered by abnormal cellular metabolism and the post bypass factors which can decrease right coronary perfusion<sup>21</sup>. Vasopressor and inotropic support will be required to maintain haemodynamic stability and prevent the spiral of hypotension and RV ischaemia<sup>23</sup>.

Dobutamine is indicated in the initial management of RV failure to increase RV contractility as well as its lowering effect on pulmonary vascular resistance<sup>24</sup>. Intravenous milrinone is another option, but may produce more profound systemic hypotension than dobutamine<sup>25</sup>, which may lead to decreased coronary perfusion and further impairment of RV function. Hypotension associated with the use of these inotropes can be offset using a vasopressor such as noradrenaline or vasopressin<sup>7</sup>.

In the case of sudden severe RV failure adrenaline should be administered as it has been shown to significantly improve RV ejection fraction<sup>26</sup>. It can be started as an infusion or given as small incremental boluses initially. There is emerging evidence that intratracheal milrinone may be a suitable first line choice in sudden severe RV failure<sup>16</sup>. Gebhard et al demonstrated in their centre's retrospective analysis that when patients developed post CPB RV failure, those who received a 5mg intratracheal bolus of milrinone had an efficacy of 60 per cent in restoring RV function, and thus not requiring further inotropic treatment<sup>27</sup>.

## Systemic blood pressure and coronary perfusion

It is crucial to maintain systemic blood pressure to sustain right coronary blood flow while the cause and treatment of RV failure is addressed<sup>2,28</sup>. Various vasopressor options are available including phenylephrine, noradrenaline, vasopressin and adrenaline. Care should be taken with both phenylephrine and noradrenaline, which have both been shown to increase pulmonary vascular resistance (phenylephrine more than noradrenaline)<sup>7</sup>. Vasopressin has been shown to have minimal effects in increasing pulmonary vascular resistance while increasing systemic resistance, hence early use of it is beneficial in this setting<sup>7,29</sup>.

## ORDER OF MANAGEMENT

Figure 4 provides a management outline once the presence of RV dysfunction is established. The priority is to assess RV preload. If it is low, then a small fluid challenge should be given. Pump blood provided by the perfusionist is the most efficient option in this setting. If the RV preload is elevated, it should be lowered by removing blood from the circulation into the CPB circuit and/or elevating the head of the operating table. If this is inadequate, then a GTN infusion can be commenced.

Concurrently, vasopressor support should be commenced or increased. Vasopressin would be the ideal agent. However, cautious use of noradrenaline is also appropriate. RV contractility must be increased using a dobutamine infusion. If dobutamine is inadequate, then an adrenaline infusion or addition of milrinone should be considered.

At any stage if there is severe haemodynamic compromise, then small boluses of adrenaline should be administered, along with an infusion. A bolus of 5mg of intratracheal milrinone is also an option in this setting.

Raised PA pressures should be treated with an inhaled pulmonary vasodilator. If this fails to regulate the PA pressures, then an intravenous pulmonary vasodilator should be instituted.

In unresponsive cases with severe haemodynamic instability, a return to CPB should be strongly considered, to provide time to further assess possible aetiologies. This is not without risk, as returning to CPB has been shown to increase both morbidity and mortality<sup>19</sup>. Insertion of an intra-aortic balloon pump should be done to promote right coronary blood flow if haemodynamic instability is not improved<sup>6</sup>. If these interventions do not restore acceptable RV function and haemodynamic stability, surgical options of veno-arterial extracorporeal membrane oxygenation and right ventricular assist device insertion need to be considered.

### Figure 4. A guide to the management of RV dysfunction post CPB

Adapted from Haddad et al<sup>2</sup>.

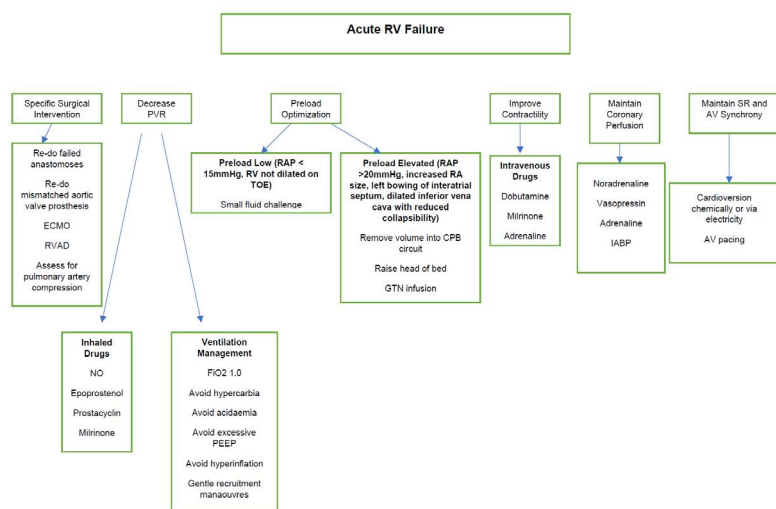

RV=Right ventricle; ECMO = extracorporeal membrane oxygenation; RVAD= right ventricular assist device; PVR=pulmonary vascular resistance; NO=nitric oxide; RAP=right atrial pressure; TOE=transoesophageal echocardiogram; FiO2=fraction inspired oxygen; PEEP=positive end expiratory pressure; RA=right atrium; CPB=cardiopulmonary bypass; GTN=glyceryl trinitrate; IABP=intra aortic balloon pump; SR=sinus rhythm; AV=atrioventricular

## CONCLUSION

RV failure is a major cause of morbidity and mortality post CPB. Identification utilising haemodynamic monitoring, TOE and visual inspection should be performed for all cases. Due to the difficulties in objectively assessing the RV, a rapid systematic approach to assessment should be undertaken and it is recommended that management follow a similar number of systematic steps. This will promote prompt recognition, treatment and a successful wean from bypass.

## REFERENCES

- Haddad F, Couture P, Tousignant C, Denault AY. The right ventricle in cardiac surgery, a perioperative perspective: I. Anatomy, physiology, and assessment. *Anesthesia & Analgesia*. 2009; 108(2):407-21.
- Haddad F, Couture P, Tousignant C, Denault AY. The right ventricle in cardiac surgery, a perioperative perspective: II. Pathophysiology, clinical importance, and management. *Anesthesia & Analgesia*. 2009; 108(2):422-33.
- Patlolla B, Beygui R, Haddad F. Right-ventricular failure following left ventricle assist device implantation. *Current Opinion in Cardiology*. 2013; 28(2):223-33.
- Mandoli GE, Cameli M, Novo G, Agricola E, Righini FM, Santoro C, et al. Right ventricular function after cardiac surgery: The diagnostic and prognostic role of echocardiography. *Heart Failure Reviews*. 2019; 24(5):625-35.
- Skidmore KL, Jones C, DeWet C. Flooding the surgical field with carbon dioxide during open heart surgery improves segmental wall motion. *The journal of extra-corporeal technology*. 2006; 38(2):123-7.
- Crystal GJ, Pagel PS. Right ventricular perfusion. *Anesthesiology*. 2018; 128(1):202-18.
- Thunberg CA, Gaitan BD, Grewal A, Ramakrishna H, Stansbury LG, Grigore AM. Pulmonary hypertension in patients undergoing cardiac surgery: Pathophysiology, perioperative management, and outcomes. *Journal of Cardiothoracic & Vascular Anesthesia*. 2013; 27(3):551-72.
- Fernández AL, El-Diasty MM, Martínez A, Alvarez J, García-Bengochea JB. A simple technique to rule out occlusion of right coronary artery after aortic valve surgery. *Annals of Thoracic Surgery*. 2011; 92(6):2281-2.
- Agrawal AM, Arora D, Sanyal A, Lohchab SS. Intraoperative right coronary artery obstruction due to aortic root prosthesis mismatch after aortic valve replacement—a case report. *J Card Surg*. 2019; 34(11):1396-8.
- Rudski LG, Lai WW, Afialo J, Hua L, Handschumacher MD, Chandrasekaran K, et al. Guidelines for the echocardiographic assessment of the right heart in adults: A report from the American Society of Echocardiography endorsed by the European Association of Echocardiography, a registered branch of the European Society of Cardiology, and the Canadian Society of Echocardiography. *J Am Soc Echocardiogr*. 2010; 23(7):685-713; quiz 86-8.
- Lang RM, Badano LP, Mor-Avi V, Afialo J, Armstrong A, Ernande L, et al. Recommendations for cardiac chamber quantification by echocardiography in adults: An update from the American Society of Echocardiography and the European Association of Cardiovascular Imaging. *J Am Soc Echocardiogr*. 2015; 28(1):1-39.e14.
- Reeves ST, Finley AC, Skubas NJ, Swaminathan M, Whitley WS, Glas KE, et al. Basic perioperative transesophageal echocardiography examination: A consensus statement of the American Society of Echocardiography and the Society of Cardiovascular Anesthesiologists. *J Am Soc Echocardiogr*. 2013; 26(5):443-56.
- Shanewise JS, Cheung AT, Aronson S, Stewart WJ, Weiss RL, Mark JB, et al. ASE/SCA guidelines for performing a comprehensive intraoperative multiplane transesophageal echocardiography examination: Recommendations of the American Society of Echocardiography Council for Intraoperative Echocardiography and the Society of Cardiovascular Anesthesiologists Task Force for Certification in Perioperative Transesophageal Echocardiography. *J Am Soc Echocardiogr*. 1999; 12(10):884-900.
- Raymond M, Grønlykke L, Couture EJ, Desjardins G, Cogan J, Cloutier J, et al. Perioperative right ventricular pressure monitoring in cardiac surgery. *Journal of Cardiothoracic & Vascular Anesthesia*. 2019; 33(4):1090-104.
- Barros LN, Uchoa RB, Mejia JAC, Nunes RR, Barros DASN, Rodrigues Filho F. Anesthetic protocol for right ventricular dysfunction management in heart transplantation: Systematic review, development and validation. *BMC Anesthesiology*. 2021; 21(1).
- Heringlake M, Berggreen AE. Intratracheal milrinone for acute right heart dysfunction: Another tool in the pocket. *Journal of Cardiothoracic & Vascular Anesthesia*. 2019; 33(3):661-2.
- Vonk-Noordegraaf A, Haddad F, Chin KM, Forfia PR, Kawut SM, Lumens J, et al. Right heart adaptation to pulmonary arterial hypertension: Physiology and pathobiology. *J Am Coll Cardiol*. 2013; 62(25 Suppl):D22-33.
- Lee M, Curley GF, Mustard M, Mazer CD. The swan-ganz catheter remains a critically important component of monitoring in cardiovascular critical care. *Can J Cardiol*. 2017; 33(1):142-7.
- Denault AY, Haddad F, Jacobsohn E, Deschamps A. Perioperative right ventricular dysfunction. *Current Opinion in Anaesthesiology*. 2013; 26(1):71-81.
- Lim HS, Gustafsson F. Pulmonary artery pulsatility index: Physiological basis and clinical application. *Eur J Heart Fail*. 2020; 22(1):32-8.
- Ventetuolo CE, Klinger JR. Management of acute right ventricular failure in the intensive care unit. *Annals of the American Thoracic Society*. 2014; 11(5):811-22.
- Goldstein JA, Barzilai B, Rosamond TL, Eisenberg PR, Jaffe AS. Determinants of hemodynamic compromise with severe right ventricular infarction. *Circulation*. 1990; 82(2):359-68.
- Kaul TK, Fields BL. Postoperative acute refractory right ventricular failure: Incidence, pathogenesis, management and prognosis. *Cardiovasc Surg*. 2000; 8(1):1-9.
- Fischer LG, Aken HV, Burkle H. Management of pulmonary hypertension: Physiological and pharmacological considerations for anesthesiologists. *Anesthesia & Analgesia*. 2003; 96(6):1603-16.

25. Carmona MJC, Martins LM, Vane MF, Longo BA, Paredes LS, Malbouisson LMS. Comparação dos efeitos da dobutamina e da milrinona sobre a hemodinâmica e o transporte de oxigênio em pacientes submetidos à cirurgia cardíaca com baixo débito cardíaco após indução anestésica. *Revista Brasileira de Anestesiologia*. 2010; 60(3):237-46.
26. Tulzo YL, Seguin P, Gacouin A, Camus C, Suprin E, Jouannic I, et al. Effects of epinephrine on right ventricular function in patients with severe septic shock and right ventricular failure: A preliminary descriptive study. *Intensive Care Medicine*. 1997; 23(6):664-70.
27. Gebhard CE, Rochon A, Cogan J, Ased H, Desjardins G, Deschamps A, et al. Acute right ventricular failure in cardiac surgery during cardiopulmonary bypass separation: A retrospective case series of 12 years' experience with intratracheal milrinone administration. *Journal of Cardiothoracic & Vascular Anesthesia*. 2019; 33(3):651-60.
28. Pinsky MR. The right ventricle: Interaction with the pulmonary circulation. *Critical Care*. 2016; 20(1).
29. Mizota T, Fujiwara K, Hamada M, Matsukawa S, Segawa H. Effect of arginine vasopressin on systemic and pulmonary arterial pressure in a patient with pulmonary hypertension secondary to pulmonary emphysema: A case report. *JA Clinical Reports*. 2017; 3(1).

## The perioperative management of patients with ventricular assist devices undergoing non-cardiac surgery

### Richella-Lea Falland MBBS FANZCA MCLinEd

**Cardiothoracic Anaesthesia Fellow, Greenlane Department of Cardiothoracic and ORL Anaesthesia, and Cardiothoracic and Vascular Intensive Care Unit, Auckland City Hospital, New Zealand**

Dr Richella-Lea Falland graduated from the University of Adelaide and completed her training in anaesthesia in hospitals throughout South Australia. She is currently undertaking a one-year fellowship in cardiothoracic anaesthesia and intensive care at Auckland City Hospital. She has developing interests in cardiothoracic and vascular anaesthesia, transoesophageal echocardiography and the management of complex cardiac patients presenting for non-cardiac surgery.

### David Sidebotham MBChB FANZCA

**Anaesthetist and Intensivist, Department of Anaesthesia and the Cardiothoracic and Vascular Intensive Care Unit, Auckland City Hospital, New Zealand**

Dr David Sidebotham is a cardiothoracic anaesthetist and intensivist at Auckland City Hospital. He has written and spoken extensively on echocardiography and mechanical cardiorespiratory support. He is an associate editor for *British Journal of Anaesthesia Education*. He is midway through a BSc (Hon) in mathematics and statistics.

### Sara Jane Allen MBChB PgDipMedEd Cambridge FANZCA FCICM

**Anaesthetist and Intensivist, Department of Cardiothoracic and ORL Anaesthesia and the Cardiothoracic and Vascular Intensive Care Unit, Auckland City Hospital, New Zealand**

Dr Sara Allen is a cardiothoracic anaesthetist and intensivist, working at Auckland City Hospital. She is the Director of Perioperative Echocardiography, and has clinical interests in echocardiography, and mechanical support, as well as training, education, and welfare within anaesthesia and intensive care medicine. Previous publication topics have included the care of transplant and mechanical support patients, ECMO, and transesophageal echocardiography.

## INTRODUCTION

Ventricular assist devices (VADs) are mechanical circulatory support devices, which provide temporary or long-term support for patients with advanced heart failure that is not responsive to maximal medical therapy. VADs may be used to support the left ventricle (LV), the right ventricle (RV), or both ventricles. In this article, we use the term VAD to describe implantable, durable continuous-flow devices used to support the LV.

The first VAD was implanted in Australia in 1994, with New Zealand following in 2005. Currently, the health jurisdictions of both countries approve funding of VADs solely as a bridge-to-heart transplantation<sup>1</sup>. Despite this restriction, the use of VADs is increasing in both countries, and there is a growing cohort of patients supported with VADs who require anaesthesia for non-cardiac conditions. Case series of patients with VADs undergoing non-cardiac surgery, and of patients completing pregnancy while receiving VAD support, report low morbidity and mortality in the immediate perioperative period and at 12 month follow-up, confirming non-cardiac surgery can be performed safely in these patient populations<sup>2</sup>.

In this article, we provide an overview of the perioperative management of patients with VADs presenting for non-cardiac surgery.

## BACKGROUND

The physiological goal of a VAD is to reduce LV work and to provide adequate systemic perfusion. These goals are achieved by active unloading of the LV and by returning blood to the aorta under positive pressure.

### Devices

In Australia and New Zealand, three devices are used for durable VAD support: the HeartMate II (Thoratec Corporation, Pleasanton, CA), HeartMate III (Thoratec Corporation, Pleasanton, CA) and the HeartWare HVAD (HeartWare International, Inc, Framingham, MA)<sup>3</sup>. All devices use continuous flow (that is, non-pulsatile) pumps. The HeartMate II uses an axial pump and the HeartMate III and HeartWare HVAD use a magnetically driven centrifugal pump. Functionally, the pumps are similar but the working speeds of the pumps are notably different. The typical pump speed for the HeartMate II is 9000 revolutions per minute (rpm), HeartMate III is 5000-6000rpm and 2500rpm for the HeartWare HVAD.

The devices are implantable and have externalized drivelines, which provide power, data capture and control. The HeartMate II is implanted sub-diaphragmatically whereas the HeartMate III and HeartWareHVAD are implanted within the pericardium. The devices drain blood from the LV apex and return blood to the ascending aorta via inflow and outflow cannulae, respectively.

### Indications

There are four indications for durable VAD support:

1. As a bridge-to-transplantation in patients with advanced heart failure.
2. As a bridge-to-candidacy for heart transplantation.
3. As bridge-to-recovery in patients with severe heart failure due to a condition where recovery may be anticipated.
4. As destination therapy in patients with advanced heart failure who are ineligible for heart transplantation.

While not approved for such use in Australia and New Zealand, destination therapy is the most common indication for VAD implantation worldwide<sup>4-7</sup>. The REMATCH trial, published in 2001, demonstrated that while destination therapy improved survival in patients with end-stage heart failure, associated morbidity was high<sup>8</sup>. Subsequently, improvements in device technology have reduced the rate of adverse events. Recent data from the Interagency Registry for Mechanically Assisted Circulatory Support (INTERMACS) shows one-year survival is 82 per cent and five-year survival is 47 per cent<sup>9</sup>. Technological improvements over time may further increase the use of VADs for destination therapy<sup>9,10</sup>.

### Complications

Despite improvements in VAD design over the past 20 years, complications are common, resulting in frequent hospitalisations. Approximately 30 per cent of patients require unplanned hospitalisation within the first six months following device implantation<sup>10</sup>. The most common complications are bleeding, infection (particularly involving the driveline), stroke, and right heart failure<sup>9</sup>. Complications may be divided into early (within 30-60 days), and late (after 60 days) (see Table 1)<sup>4,5,11-18</sup>.

**Table 1. LVAD complications<sup>4,5,11-18</sup>**

Complication	Incidence	Comment
Bleeding	32%	<ul style="list-style-type: none"> <li>▪ May necessitate surgical re-exploration.</li> </ul>
<ul style="list-style-type: none"> <li>▪ Post-implantation.</li> <li>▪ Gastrointestinal bleeding.</li> <li>▪ Intracerebral haemorrhage.</li> </ul>	<ul style="list-style-type: none"> <li>20%</li> <li>2-9%</li> </ul>	<ul style="list-style-type: none"> <li>▪ Recurrent bleeding occurs in up to 10 per cent of patients.</li> </ul>
Infection	33-50%	<ul style="list-style-type: none"> <li>▪ Second most common acute complication after bleeding.</li> <li>▪ Includes driveline and pump pocket infections and endocarditis.</li> </ul>
Right ventricular failure	15-25%	
<ul style="list-style-type: none"> <li>▪ Post-implantation.</li> <li>▪ Late-onset.</li> </ul>	<ul style="list-style-type: none"> <li>10%</li> </ul>	
Thrombotic complications	2-9%	<ul style="list-style-type: none"> <li>▪ Reduced rates with strict adherence to anticoagulation regimen.</li> </ul>
<ul style="list-style-type: none"> <li>▪ Device thrombosis.</li> <li>▪ Stroke.</li> </ul>	<ul style="list-style-type: none"> <li>10-30%</li> </ul>	
Aortic valve insufficiency	> 30%	<ul style="list-style-type: none"> <li>▪ Increased incidence and severity with increasing time from implantation.</li> </ul>
Ventricular arrhythmias		
Device malfunction	5-11%	<ul style="list-style-type: none"> <li>▪ Due to pump thrombosis or factors relating to VAD hardware.</li> </ul>

## MANAGEMENT FOR NON-CARDIAC SURGERY

Patients with VADs present for a range of non-cardiac procedures,<sup>19-21</sup> and with improving survival, it is likely that numbers will continue to increase. Estimates vary, with 4-33 per cent of patients undergoing non-cardiac surgery during their period of VAD support. Upper gastrointestinal endoscopies account for the majority of non-cardiac procedures, reflecting the increased risk of gastrointestinal bleeding in this patient group and the requirement for anticoagulation (see below)<sup>22</sup>.

Traditionally, anaesthesia care in patients with VADs has been managed exclusively by cardiothoracic anaesthetists in centres which implant and routinely manage these devices. However, increasing numbers of device implantations, especially in the USA, has prompted concerns about resource limitations associated with this approach. Increasingly, non-cardiac anaesthetists are managing patients with VADs presenting for non-cardiac surgery. Data suggests there is no difference in outcome from this approach when managed appropriately<sup>23-26</sup>. Several non-specialist centres have described the training and safety programs they have developed to care for VAD-supported patients<sup>23,27</sup>. It is still recommended that cardiac anaesthetists be involved in patients who require long-term pharmacological support, have major comorbidities, or are undergoing major surgery<sup>23</sup>. In Australasia, given the lower numbers, it is likely that patients will continue to be managed in cardiac centres with experience in VADs – at least in the short term, however as numbers of patients rise non-cardiac anaesthetists are increasingly likely to be involved in the care of patients supported with VADs.

Notwithstanding the comments above, patients with VADs undergoing non-cardiac surgery are at increased risk of perioperative problems, most notably hypotension<sup>26</sup>. Other common perioperative problems include acute kidney injury, excess bleeding, and arrhythmias<sup>20,28</sup>.

## PREOPERATIVE ASSESSMENT

Prior to all non-emergency interventions, patients should be assessed by a multidisciplinary team consisting of the anaesthetist, the proceduralist, a heart failure cardiologist, and a VAD nurse specialist or perfusionist. Other specialists, such as a cardiac surgeon or haematologist, may also need to be consulted<sup>29</sup>.

The preoperative assessment should focus on the patient's functional status, their organ function (including renal, hepatic, and haematological), medications, and the functioning of the VAD<sup>24</sup>. Any reversible problems, such as electrolyte disturbance, hypovolaemia, and so on, should be corrected prior to surgery. Common medications include diuretics, pulmonary vasodilators (for example, sildenafil) calcium antagonists, angiotensin converting enzyme inhibitors, angiotensin receptor blockers, warfarin, and antiplatelet agents. Occasionally, patients with pulmonary hypertension and RV failure may be receiving long-term inhaled or intravenous pulmonary vasodilators or inotrope infusions<sup>24,30</sup>.

Clinical examination of the cardiovascular system is challenging. Arterial pulses are typically non-palpable. Non-invasive blood pressure measurements may require a portable continuous wave Doppler device. Device hum obscures the heart sounds and any murmurs.

Investigations should include a full blood count, electrolytes and creatinine, liver function tests, coagulation studies, an ECG, and a chest radiograph. Greater than usual blood loss should be anticipated, and blood typed and crossmatched for transfusion as appropriate. For all but very minor procedures, an up-to-date echocardiogram should be available. The anaesthetist should particularly focus on RV function, which is frequently impaired.

A high proportion of VAD patients have implanted cardiac defibrillators (ICDs) or pacemakers. Immediately prior to surgery, ICDs and pacemakers should be programmed to an asynchronous mode and the anti-tachycardia and defibrillator functions disabled to avoid triggering by electrical diathermy<sup>24</sup>.

Arrangements should be made for postoperative care in the intensive care unit (ICU) or high dependency unit (HDU). Following minor procedures, care in the coronary care unit (CCU) may be appropriate.

### Anticoagulation

Patients with durable VADs are anticoagulated with warfarin, with a target international normalised ratio (INR) of 2.5-3.5 for the HeartMate II and 2.0-3.0 for the HeartMate III and HeartWare HVAD. All devices require concurrent use of an antiplatelet agent, most commonly aspirin. However, in the presence of aspirin resistance, a second anti-platelet agent may be added, typically clopidogrel.

For elective surgery, cessation of warfarin five days preoperatively and bridging with an infusion of unfractionated heparin once the INR is below 2.0 is recommended<sup>24,30</sup>. For emergency surgery, reversal of warfarin to INR below 1.5 may be required depending on the procedure and the patients history of thrombotic events<sup>2</sup>. Pharmacological reversal of warfarin should be with a factor concentrate such as Prothrombinex, not vitamin K, as the patient will require reintroduction of warfarin in the early postoperative period.

## INTRAOPERATIVE MANAGEMENT

### Monitoring

In addition to standard monitors, patients with VADs should have invasive arterial blood pressure monitoring for all but the most minor procedures<sup>32</sup>. If bleeding is a possibility, large-bore intravenous access should be obtained. Non-pulsatile arterial flow makes arterial line placement challenging; ultrasound-guidance is useful<sup>33</sup>. For endoscopic or other minor procedures, non-invasive alternatives to arterial catheterisation may be appropriate<sup>23,28</sup>. Of the non-invasive methods, intermittent mean arterial blood pressure obtained via Doppler ultrasound is the most reliable<sup>34</sup>. The quality of the pulse oximetry trace may be degraded by non-pulsatile flow; however satisfactory readings are usually possible. Near-infrared (cerebral) spectroscopy (NIRS), which does not rely on pulsatile flow, is widely used in VAD-supported patients undergoing non-cardiac surgery<sup>19,23,35</sup>. NIRS is particularly useful if the pulse oximetry signal is poor. Bispectral index monitoring should be considered, as the usual haemodynamic responses to pain or awareness may be absent or blunted. External defibrillator pads should be placed prior to inducing anaesthesia<sup>24</sup>.

In a minority of cases, a central venous catheter (CVC) may be appropriate<sup>19,23</sup>. A CVC should be considered when large fluid shifts or the use of inotropic agents is anticipated<sup>24</sup>. A pulmonary artery catheter is rarely indicated.

Intraoperative echocardiography has a key role in evaluating the haemodynamic state and for guiding adjustments to VAD settings (see below)<sup>36</sup>. Consequently, echocardiography – usually transoesophageal echocardiography – is appropriate in most circumstances.

### VAD preparation and management

The VAD specialist should interrogate the device prior to surgery, be present throughout the procedure, and remain in close communication with the anaesthetist and proceduralist<sup>24,32</sup>. In particular, reduced VAD flow (litres per minute) for a given pump speed (rpm) should be immediately discussed.

During transport to the operating room, the patient's VAD will be powered by batteries (typical battery life is six to 10 hours). Once positioned on the operating table, the VAD should be connected to a uninterrupted power supply<sup>24</sup>. Spare batteries should remain with the patient throughout the case. The effect of the patient's haemodynamic state on the function of the VAD is discussed below.

### Anaesthesia technique

General anaesthesia, sedation, and monitored anaesthesia care are all appropriate techniques for patients with VADs. Major regional techniques and neuraxial blocks are typically avoided due to the risks associated with anticoagulation and the higher incidence of hepatic dysfunction in this patient population<sup>29</sup>.

A wide range of drugs have been safely used for inducing and maintaining anaesthesia<sup>33,37-40</sup> and superiority of one agent or combination of agents has not been demonstrated. Irrespective of the drugs used, careful attention to maintaining normotension is essential, as both hypotension (due to excessive vasodilation) and hypertension can impact performance of the VAD.

Avoiding hypercarbia and hypoxia are important, as both can precipitate abrupt rises in pulmonary vascular resistance (PVR), which can in turn cause acute RV failure in patients with impaired RV function. For this reason, hypoventilation, as a consequence of deep sedation or spontaneous ventilation via a laryngeal mask airway, should be avoided.

### Haemodynamic management

Continuous flow VADs are preload dependant and afterload sensitive, meaning the output of the VAD is reduced by low preload and high afterload. Thus, marked changes in blood pressure or intravascular volume status can affect VAD flow and, therefore, the patient's cardiac output. In particular, sudden hypovolaemia can critically reduce the preload to the VAD precipitating a suction event.

A mean arterial pressure (MAP) target of 60-80 mmHg throughout the perioperative period is appropriate<sup>2</sup>. A MAP persistently below 60 mmHg risks causing or exacerbating end-organ dysfunction – particularly renal dysfunction. A MAP above 80 mmHg can adversely affect VAD performance, resulting in lower flow for a given pump speed. A MAP persistently above 90 mmHg is associated with worsening of aortic regurgitation, pump thrombosis, and stroke<sup>41-43</sup>. Blood pressure control is achieved by carefully administering vasopressors (for example, metaraminol, noradrenaline) and, less frequently, vasodilators (for example, magnesium, nitroglycerine) rather than adjusting the VAD settings. Indeed, only very rarely should VAD settings be changed during the perioperative period.

Reduced preload to the VAD is most commonly due to hypovolaemia, which is treated in the usual way with fluids and blood component therapy. However, reduced preload to the VAD can also occur due to RV dysfunction.

Most patients supported by VADs have existing RV dysfunction and pulmonary hypertension. Indeed, some are in incipient or frank right-heart failure. Factors that affect RV afterload, such as aggressive positive pressure ventilation, hypercarbia and hypoxia, or abrupt changes in the patient position (see below) can precipitate acute RV failure. Thus, both excessive fluid administration (precipitating RV failure) and hypovolaemia can reduce VAD preload. Inadequate VAD preload from any cause can lead to a suction event, described below.

Echocardiography is an essential tool for diagnosing the cause of low VAD flows and for guiding ongoing therapy. Low preload to the VAD is associated with an underfilled LV. If the cause is RV dysfunction, the right heart is typically dilated and the RV poorly contractile. The ventricular and atrial septa will be displaced markedly leftwards. If the cause is hypovolaemia, the RV will not be excessively dilated, relative to what is normal for that patient, and the ventricular and atrial septa not particularly displaced from the normal position.

RV dysfunction is treated with inotropic agents. Milrinone is a good choice due to the combination of pulmonary vasodilation and inotropy. Coadministration of noradrenaline mitigates milrinone-induced hypotension. Adrenaline is another option but can cause troubling lactic acidosis, which increases PVR. Increasing respiratory rate can correct hypercarbia without increasing RV afterload. High ventilation pressures and high positive end-expiratory pressure should be avoided.

### Suction events

Suction events occur when low preload to the VAD causes the LV to “suckdown” on to the inflow cannula positioned in the LV apex. Typically, the low flow alarm on the VAD is triggered, and the patient becomes acutely hypotensive. Suction events can also trigger malignant ventricular arrhythmias. With echocardiography, the LV appears dramatically reduced in size, the ventricular septum is displaced markedly leftward and there may be severe turbulence at the origin of the inflow cannula.

Initial treatment involves acutely reducing VAD pump speed to release the suction and then slowly increasing pump speed over 30-60 seconds. Subsequent treatment depends on the cause – either fluid for hypovolaemia or an inotrope for acute RV failure.

### Haematological management

Depending on the procedure, the bridging heparin infusion may be continued throughout the intraoperative period (uncommon) or stopped two to four hours before surgery (common).

Patients with VADs have high rates of bleeding complications. In a study by Morgan et al, 36 per cent of patients supported with VADs undergoing non-cardiac surgery required a red blood cell transfusion perioperatively, with the need for transfusion strongly associated with not reversing warfarin prior to surgery<sup>38</sup>. Other series report red blood cell transfusion rates of 4-41 per cent<sup>20,23,28,35,44,45</sup>.

The increased bleeding risk is not only related to anticoagulant therapy. Patients with continuous flow VADs develop acquired von Willebrand syndrome and factor XIII deficiency<sup>2,31</sup>. Acquired von Willebrand syndrome occurs due to device-related circulatory shear stress, which induces glycoprotein unfolding and enzymatic cleavage – resulting in the loss of high molecular weight von Willebrand factor multimers<sup>46</sup>. While not routine<sup>28</sup>, administration of desmopressin should be considered in procedures at high risk of substantial blood loss.

Additionally, patients with continuous flow VADS are at risk of development of gastrointestinal arteriovenous malformations, which can lead to gastrointestinal bleeding during the perioperative period.

### Antibiotic prophylaxis and infection control

The development of infection within the device can be catastrophic, potentially leading to persistent sepsis and arterial embolisation. Explantation of the device is occasionally required. Therefore, meticulous attention to aseptic technique is mandatory. For surgery involving the gastrointestinal tract, broad spectrum antibiotics and consideration of the addition of an antifungal agent is appropriate. A combination of vancomycin and cephazolin is frequently used for other procedures<sup>2</sup>.

Wherever possible, surgical preparation and draping should exclude the externalised driveline entry site, to avoid contamination.

## SURGICAL CONSIDERATIONS

As with other implanted electrical devices, bipolar diathermy should be used in preference to monopolar diathermy to avoid potential electromagnetic interference. When there is no alternative to monopolar diathermy, the grounding pad should be placed as far as possible from the pump and driveline.

Damage to the driveline can cause the device to malfunction or cease to function, which may be catastrophic. Therefore, patient positioning should be done in a coordinated and cautious manner, with a nominated person (usually the VAD specialist) responsible for the safety of the driveline, the controller, and the power source<sup>24,47</sup>.

The theatre team should be aware of the effects of patient positioning on VAD function. Raising the head of the bed suddenly can lead to reduced preload to the VAD. Similarly, lowering the head of the bed increases intrathoracic pressure and augments RV filling, adversely affecting RV function, which in turn can reduce preload to the VAD. Prone positioning should be avoided if possible. However, there are reported cases of successful prone positioning for neurosurgical procedures<sup>48</sup>. Pneumoperitoneum to facilitate intraabdominal surgery has complex effects on cardiovascular performance<sup>49</sup>. Initial insufflation of carbon dioxide compresses the inferior vena cava, augmenting systemic venous return. Subsequently, venous return is reduced due to reduced transit of blood through the inferior vena cava from the lower body. Raised intraabdominal pressure increases LV afterload. The effect of carbon dioxide gas is to increase arterial carbon dioxide tension, which in turn can increase PVR. A simple rule of thumb is to assume surgical pneumoperitoneum may adversely affect both VAD preload and afterload, potentially reducing pump flow or precipitating a suction event. Pneumoperitoneum should be established in a step-wise manner, allowing time for the anaesthetist to support the circulation with fluids and vasopressors<sup>50</sup>. Intraabdominal pressure should be kept below 12 cm H<sub>2</sub>O. Insufflation ports should not be placed in close proximity to the device or the driveline. The International Society for Heart and Lung Transplantation (ISHLT) recommend a cardiac surgeon be immediately available, or present in the operating theatre, for procedures occurring in close proximity to the VAD<sup>32</sup>.

## ADVANCED CARDIAC LIFE SUPPORT

Diagnosis of cardiac arrest can be challenging due to the monitoring issues outlined above. There may be uncertainty as to the primary cause. The two most likely causes of cardiac arrest or near cardiac arrest are sustained malignant ventricular arrhythmias and suction events. Causes unrelated to the heart and VAD must also be considered, such as hypoxaemia, tension pneumothorax, and anaphylaxis. Only rarely is intraoperative cardiac arrest caused by device malfunction, such as damage to the driveline, loss of power, or pump failure. However, VAD-related causes must be considered when the operative site is close to the device.

In the presence of severe hypotension, the anaesthetist should immediately confirm the problem is real and inform the theatre team. The anaesthetist should inspect the patient (colour, pupils), the ECG, the capnograph trace, and listen to the VAD hum. The VAD specialist should report the pump speed and device flow, noting any changes. A rapid assessment tool for the unresponsive patient with a VAD has been developed by the American Heart Association (AHA)<sup>51</sup>. While not designed for patients in the operating room, the tool is easily adapted to cardiac arrest under anaesthesia. Echocardiography is an invaluable tool for assessing hypotension in patients with VADs. The AHA guideline also includes an echo-checklist for diagnosing and managing acutely unwell patients<sup>51</sup>, which again, is applicable to intraoperative cardiac arrest. We strongly recommend anaesthetists read this document prior to caring for patients with VADs for non-cardiac surgery. If required, cardioversion and defibrillation are both safe in terms of VAD electrical functioning. Chest compressions are relatively contraindicated due to the potential for damaging the device. However, the AHA guideline recommends chest compressions be commenced for a sustained MAP less than 50 mmHg and/or an end-tidal carbon dioxide partial pressure less than 20 mmHg. If chest compressions are administered, an echocardiogram should be performed in the immediate post-resuscitation period to check the position of the inflow cannula and functioning of the device.

## POSTOPERATIVE CARE

Most patients are able to be safely extubated at the completion of non-cardiac surgery and discharged to the post-anaesthesia care unit. Ongoing postoperative care is most appropriately provided in the ICU/HDU or CCU.

Specific postoperative considerations for patients with VADs include optimisation of intravascular volume status, prevention of hypoxaemia and hypercarbia, prevention of nosocomial sepsis, and the provision of adequate analgesia. Untreated pain can lead to sympathetic nervous system stimulation, hypoxia and hypercarbia, and chest splinting – all of which can adversely affect VAD performance. Any change in the functioning of the VAD – in particular, reduced flow for a given pump speed – should be urgently investigated with an echocardiogram.

If present, ICDs and pacemakers should be interrogated and returned to preoperative settings in the immediate postoperative period. Prior to reprogramming an ICD, the patient should remain connected to an external defibrillator.

The appropriate time to reintroduce anticoagulant and antiplatelet agents reflects a balance between the risks of surgical bleeding and pump thrombosis. The decision should be made by the multidisciplinary team. ISHLT guidelines recommend using unfractionated heparin (or a heparin alternative) to bridge the patient to

a therapeutic INR<sup>32</sup>. However, a case series by Slaughter et al, demonstrated no short-term increased risk of thromboembolic events when bridging heparin was omitted<sup>52</sup>. In contrast, Nelson et al demonstrated no increased rates of perioperative bleeding or transfusion when heparin bridging was used<sup>22</sup>. Our practice is to recommence an infusion of unfractionated heparin and oral warfarin once the acute risk of bleeding has passed – usually one to two days following surgery – and continue the heparin infusion until the INR is above 2.0 (HeartWare HVAD). Antiplatelet agents should be reintroduced at the same time as anticoagulants.

## CONCLUSIONS

Managing patients with VADs for non-cardiac surgery presents many challenges. Multiple case series have demonstrated a high level of safety can be achieved when patients are managed by a multidisciplinary team with input from different specialists. There is a growing body of evidence showing that non-cardiac anaesthetists are able to safely manage this patient population, assuming they have an adequate understanding of the relevant perioperative issues and access to appropriate support.

The key aspects for anaesthetists are: (1) managing the haemodynamic state; (2) understanding the determinants of VAD performance – particularly the causes of reduced VAD preload; (3) challenges in patient monitoring; (4) managing perioperative anticoagulation; and (5) appreciating the importance of strict aseptic technique. Anaesthetists unfamiliar in managing patients with VADs are encouraged to consult colleagues with specific expertise, notably anaesthetists and cardiologists experienced in mechanical circulatory support. VAD nurse or perfusion specialists are another valuable resource.

## REFERENCES

- Sivathanan C, Hayward C, Jansz P, Sibal AK, Chen Chen, Cally HKL, et al. Durable mechanical circulatory support across the asia-pacific region. *J Heart Lung Transplant*. 2020; 39(11):1195-8.
- Hessel EA, 2nd. Management of patients with implanted ventricular assist devices for noncardiac surgery: A clinical review. *Semin Cardiothorac Vasc Anesth*. 2014; 18(1):57-70.
- McGiffin D. Destination vad's in australia and new zealand. *Heart, Lung and Circulation*. 2016; 25(8):e91-e2.
- Kirklín JK, Cantor R, Mohacsi P, Gummert J, De By T, Hannan MM, et al. First annual imacs report: A global international society for heart and lung transplantation registry for mechanical circulatory support. *J Heart Lung Transplant*. 2016; 35(4):407-12.
- Kirklín JK, Pagani FD, Kormos RL, Stevenson LW, Blume ED, Myers SL, et al. Eighth annual intermacs report: Special focus on framing the impact of adverse events. *J Heart Lung Transplant*. 2017; 36(10):1080-6.
- Group NCHFGW, Atherton JJ, Sindone A, De Pasquale CG, Driscoll A, MacDonald PS, et al. National heart foundation of australia and cardiac society of australia and new zealand: Guidelines for the prevention, detection, and management of heart failure in australia 2018. *Heart Lung Circ*. 2018; 27(10):1123-208.
- Mirza KK, Xie R, Cowger J, Kirklín JK, Meyns B, Gustafsson F, et al. Comparative analysis of regional outcomes and adverse events after continuous-flow left ventricular assist device implantation: An imacs analysis. *J Heart Lung Transplant*. 2020; 39(9):904-14.
- Rose EA, Gelijns AC, Moskowitz AJ, Heitjan DF, Stevenson LW, Dembitsky W, et al. Long-term use of a left ventricular assist device for end-stage heart failure. *N Engl J Med*. 2001; 345(20):1435-43.
- Teuteberg JJ, Cleveland JC, Jr., Cowger J, Higgins RS, Goldstein DJ, Keebler M, et al. The society of thoracic surgeons intermacs 2019 annual report: The changing landscape of devices and indications. *Ann Thorac Surg*. 2020; 109(3):649-60.
- Gustafsson F, Shaw S, Lavee J, Saeed D, Pya Y, Krabatsch T, et al. Six-month outcomes after treatment of advanced heart failure with a full magnetically levitated continuous flow left ventricular assist device: Report from the elevate registry. *Eur Heart J*. 2018; 39(37):3454-60.
- Demirozu ZT, Radovancevic R, Hochman LF, Gregoric ID, Letsou GV, Kar B, et al. Arteriovenous malformation and gastrointestinal bleeding in patients with the heartmate ii left ventricular assist device. *J Heart Lung Transplant*. 2011; 30(8):849-53.
- Islam S, Cevik C, Madonna R, Frandah W, Islam E, Islam S, et al. Left ventricular assist devices and gastrointestinal bleeding: A narrative review of case reports and case series. *Clin Cardiol*. 2013; 36(4):190-200.
- Jorde UP, Uriel N, Nahumi N, Bejar D, Gonzalez-Costello J, Thomas SS, et al. Prevalence, significance, and management of aortic insufficiency in continuous flow left ventricular assist device recipients. *Circ Heart Fail*. 2014; 7(2):310-9.
- Kilic A, Acker MA, Atluri P. Dealing with surgical left ventricular assist device complications. *J Thorac Dis*. 2015; 7(12):2158-64.
- Patel H, Madanieh R, Kosmas CE, Vatti SK, Vittorio TJ. Complications of continuous-flow mechanical circulatory support devices. *Clin Med Insights Cardiol*. 2015; 9(Suppl 2):15-21.
- Willey JZ, Gavallas MV, Trinh PN, Yuzefpolskaya M, Reshad Garan A, Levin AP, et al. Outcomes after stroke complicating left ventricular assist device. *J Heart Lung Transplant*. 2016; 35(8):1003-9.
- Rich JD, Gosev I, Patel CB, Joseph S, Katz JN, Eckman PM, et al. The incidence, risk factors, and outcomes associated with late right-sided heart failure in patients supported with an axial-flow left ventricular assist device. *J Heart Lung Transplant*. 2017; 36(1):50-8.
- Han JJ, Acker MA, Atluri P. Left ventricular assist devices. *Circulation*. 2018; 138(24):2841-51.

19. Sheu R, Joshi B, High K, Thinh Pham D, Ferreira R, Cobey F. Perioperative management of patients with left ventricular assist devices undergoing noncardiac procedures: A survey of current practices. *J Cardiothorac Vasc Anesth.* 2015; 29(1):17-26.
20. Degnan M, Brodt J, Rodriguez-Blanco Y. Perioperative management of patients with left ventricular assist devices undergoing noncardiac surgery. *Ann Card Anaesth.* 2016; 19(4):676-86.
21. Briasoulis A, Chehab O, Alvarez P. In-hospital outcomes of lvad patients undergoing non-cardiac surgery: Analysis of the national inpatient sample. *Journal of the American College of Cardiology.* 2020; 75(11).
22. Nelson EW, Heinke T, Finley A, Guldan GJ, Gaddy P, Matthew Toole J, et al. Management of lvad patients for noncardiac surgery: A single-institution study. *J Cardiothorac Vasc Anesth.* 2015; 29(4):898-900.
23. Stone M, Hinchey J, Sattler C, Evans A. Trends in the management of patients with left ventricular assist devices presenting for noncardiac surgery: A 10-year institutional experience. *Semin Cardiothorac Vasc Anesth.* 2016; 20(3):197-204.
24. Bhandary S. Con: Cardiothoracic anesthesiologists are not necessary for the management of patients with ventricular assist devices undergoing noncardiac surgery. *J Cardiothorac Vasc Anesth.* 2017; 31(1):382-7.
25. Stoicea N, Sacchet-Cardozo F, Joseph N, Kilic A, Sipes A, Essandoh M. Pro: Cardiothoracic anesthesiologists should provide anesthetic care for patients with ventricular assist devices undergoing noncardiac surgery. *J Cardiothorac Vasc Anesth.* 2017; 31(1):378-81.
26. Brown TA, Kerpelman J, Wolf BJ, McSwain JR. Comparison of clinical outcomes between general anesthesiologists and cardiac anesthesiologists in the management of left ventricular assist device patients in noncardiac surgeries and procedures. *J Cardiothorac Vasc Anesth.* 2018; 32(5):2104-8.
27. Knott VH, Zhao CB, Huang J. A safety initiative for noncardiac anesthesia providers caring for patients with left ventricular assist devices. *J Cardiothorac Vasc Anesth.* 2020; 34(7):1995-8.
28. Mathis MR, Sathishkumar S, Kheterpal S, Caldwell MD, Pagani FD, Jewell ES, et al. Complications, risk factors, and staffing patterns for noncardiac surgery in patients with left ventricular assist devices. *Anesthesiology.* 2017; 126(3):450-60.
29. Roberts SM, Hovord DG, Kodavatiganti R, Sathishkumar S. Ventricular assist devices and non-cardiac surgery. *BMC Anesthesiol.* 2015; 15:185.
30. Potapov EV, Antonides C, Crespo-Leiro MG, Combes A, Farber G, Hannan MM, et al. 2019 experts expert consensus on long-term mechanical circulatory support. *Eur J Cardiothorac Surg.* 2019; 56(2):230-70.
31. Kwak J, Majewski M, LeVan PT. Heart transplantation in an era of mechanical circulatory support. *J Cardiothorac Vasc Anesth.* 2018; 32(1):19-31.
32. Feldman D, Pamboukian SV, Teuteberg JJ, Birks E, Lietz K, Moore SA, et al. The 2013 international society for heart and lung transplantation guidelines for mechanical circulatory support: Executive summary. *J Heart Lung Transplant.* 2013; 32(2):157-87.
33. Ficke DJ, Lee J, Chaney MA, Bas H, Vidal-Melo MF, Stone ME. Case 6-2010: Noncardiac surgery in patients with a left ventricular assist device. *J Cardiothorac Vasc Anesth.* 2010; 24(6):1002-9.
34. Bennett MK, Roberts CA, Dordunoo D, Shah A, Russell SD. Ideal methodology to assess systemic blood pressure in patients with continuous-flow left ventricular assist devices. *J Heart Lung Transplant.* 2010; 29(5):593-4.
35. Barbara DW, Wetzel DR, Pulido JN, Pershing BS, Park SJ, Stulak JM, et al. The perioperative management of patients with left ventricular assist devices undergoing noncardiac surgery. *Mayo Clin Proc.* 2013; 88(7):674-82.
36. Stainback RF, Estep JD, Agler DA, Birks EJ, Bremer M, Hung J, et al. Echocardiography in the management of patients with left ventricular assist devices: Recommendations from the american society of echocardiography. *Journal of the American Society of Echocardiography.* 2015; 28(8):853-909.
37. Kartha V, Gomez W, Wu B, Tremper K. Laparoscopic cholecystectomy in a patient with an implantable left ventricular assist device. *BJA: British Journal of Anaesthesia.* 2008; 100(5):652-5.
38. Morgan JA, Paone G, Neme HW, Henry SE, Gerlach B, Williams CT, et al. Non-cardiac surgery in patients on long-term left ventricular assist device support. *J Heart Lung Transplant.* 2012; 31(7):757-63.
39. Sathishkumar S, Kodavatiganti R, Plummer S, High K. Perioperative management of a patient with an axial-flow rotary ventricular assist device for laparoscopic ileo-colectomy. *J Anaesthesiol Clin Pharmacol.* 2012; 28(1):101-5.
40. Iwata S, Yokokawa S, Sato M, Ozaki M. Anesthetic management of a patient with a continuous-flow left ventricular assist device for video-assisted thoracoscopic surgery: A case report. *BMC Anesthesiology.* 2020; 20(1):18.
41. Najjar SS, Slaughter MS, Pagani FD, Starling RC, McGee EC, Eckman P, et al. An analysis of pump thrombus events in patients in the heartware advance bridge to transplant and continued access protocol trial. *J Heart Lung Transplant.* 2014; 33(1):23-34.
42. Nassif ME, Tibrewala A, Raymer DS, Andruska A, Novak E, Vader JM, et al. Systolic blood pressure on discharge after left ventricular assist device insertion is associated with subsequent stroke. *J Heart Lung Transplant.* 2015; 34(4):503-8.
43. Patil NP, Mohite PN, Sabashnikov A, Dhar D, Weymann A, Zeriuoh M, et al. Does postoperative blood pressure influence development of aortic regurgitation following continuous-flow left ventricular assist device implantation? *Eur J Cardiothorac Surg.* 2016; 49(3):788-94.
44. Chung M. Perioperative management of the patient with a left ventricular assist device for noncardiac surgery. *Anesth Analg.* 2018; 126(6):1839-50.
45. Vigneswaran Y, Wang V, Krezalek M, Prachand V, Wyers S, Juricek C, et al. Laparoscopic procedures in patients with cardiac ventricular assist devices. *Surg Endosc.* 2019; 33(7):2181-6.
46. Bartoli CR, Restle DJ, Zhang DM, Acker MA, Atluri P. Pathologic von willebrand factor degradation with a left ventricular assist device occurs via two distinct mechanisms: Mechanical demolition and enzymatic cleavage. *J Thorac Cardiovasc Surg.* 2015; 149(1):281-9.
47. Nelson JA, Mauerer WJ, Barbara DW. Left ventricular assist devices and noncardiac surgery. *Adv Anesth.* 2018; 36(1):99-123.

48. Connors CW, Poltak JM, Christie AA. Noncardiac surgery in the prone position in patients with ventricular assist devices. *J Cardiothorac Vasc Anesth.* 2012; 26(1):e6-7.
49. Atkinson TM, Giraud GD, Togioka BM, Jones DB, Cigarroa JE. Cardiovascular and ventilatory consequences of laparoscopic surgery. *Circulation.* 2017; 135(7):700-10.
50. Hwang KY, Hwang NC. Facilitating noncardiac surgery for the patient with left ventricular assist device: A guide for the anesthesiologist. *Ann Card Anaesth.* 2018; 21(4):351-62.
51. Peberdy MA, Gluck JA, Ornato JP, Bermudez CA, Griffin RE, Kasirajan V, et al. Cardiopulmonary resuscitation in adults and children with mechanical circulatory support: A scientific statement from the american heart association. *Circulation.* 2017; 135(24):e1115-e34.
52. Slaughter MS, Naka Y, John R, Boyle A, Conte JV, Russell SD, et al. Post-operative heparin may not be required for transitioning patients with a heartmate ii left ventricular assist system to long-term warfarin therapy. *J Heart Lung Transplant.* 2010; 29(6):616-24.





# Coagulation and blood

**Transfusion implications in a COVID-19 era**

Michelle Roets, David Sturgess, Melinda Dean

---

**Direct acting oral anticoagulants –  
pharmacology and perioperative considerations**

Kate Drummond

---

## Transfusion implications in a COVID-19 era

### Michelle Roets MBChB, DA, FCARCSI, FANZCA, MSc

Consultant anaesthetist, lead of the intraoperative cell salvage (ICS) service, Royal Brisbane and Women's Hospital (RBWH), Queensland

Dr Michelle Roets is currently a PhD student with the University of Queensland (UQ), studying the cost and immunological benefits of ICS.

### David Sturgess MBBS, PhD, PGDipCU, FRACGP, FANZCA, FCICM, AFRACMA, GAICD

Associate Professor, Eminent Staff Specialist and Director of Anaesthesia Surgical Treatment and Rehabilitation Hospital (STARS) and Mater Research Institute, The University of Queensland

Associate Professor David Sturgess is a dual-qualified anaesthetist and intensive care physician. One of his core research interests is characterisation of the inflammatory response to surgery and critical illness.

### Melinda Dean BAS, PhD

Senior lecturer in Biomedical Science at the University of the Sunshine Coast and Adjunct Research Fellow at Australian Red Cross Lifeblood

Dr Melinda Dean's research is focused at the interface of immunology and haematology with expertise in the fields of innate immunology, inflammation, blood transfusion and erythrocyte structure and function.

## INTRODUCTION

Severe acute respiratory syndrome coronavirus 2 (SARS-CoV-2) resulting in COVID-19 has had major consequences internationally. Originally a third of COVID-19 patients in the UK were estimated to die<sup>1</sup>. By 17 July 2021, according to the WHO (World Health Organization) dashboard, there were 188,655,968 confirmed cases and 4,067,517 deaths related to COVID-19<sup>2</sup>. The consequences to transfusion practice, treatment and blood product supply implications were assessed by Stanworth et al (Lancet 2020) during a systematic review of published literature (considering more than 9000 citations and including 121 citations)<sup>3</sup>. Other implications of transfusion alternatives, and the ability to use viscoelastic testing in addition to standard laboratory measurements when managing transfusion and coagulation in COVID-19 patients were considered in this review.

## COVID-19: COAGULATION IMPLICATIONS

Even though respiratory failure remained the most relevant feature of COVID-19, abnormal coagulation and fibrin metabolism were of interest. COVID-19 patients (compared to controls) presented with lower antithrombin levels and prothrombin time and higher D-dimer values, fibrin/fibrinogen degradation products (FDP) and fibrinogen. Higher D-dimer and FDP values and shorter thrombin times were associated with poorer prognosis<sup>4</sup> and increased mortality<sup>5</sup>. Anecdotal reports described frequent clotting in ECMO circuits, when used to treat patients with COVID-19 related respiratory failure<sup>6</sup>. Anaemia and thrombocytopenia were uncommon but if present associated with worse outcomes.

Coagulation abnormalities and disease severity were closely related. Lin et al (2021) in a meta-analysis (1341 cases across 13 studies) found that thrombocytopenia, high D-dimer and high fibrinogen levels on admission predicted worse outcomes<sup>7</sup>. Similarly Malas et al (Lancet 2020, 8271 cases across 42 studies) found thromboembolic events were increased in those with severe disease and associated with a higher mortality rate<sup>8</sup>. Al-Samkari et al studied the incidence of venous thromboembolism (VTE), disseminated intravascular coagulation (DIC) and haemorrhage in critically ill COVID-19 patients (n=144). The overall thrombotic complication rate was 9.5 per cent. D-dimer level is commonly assessed in critically ill patients. Both D-dimer and fibrinogen increases were statistically significant predictors of thrombotic complications and increased D-dimer levels predicted non-survivors. DIC occurred in three patients (International Society for Thrombosis and Haemostasis definition)<sup>9</sup>. It is worthwhile to note that others found a higher incidence of DIC<sup>5</sup>. Importantly the way venous thrombo-embolism and disseminated intravascular coagulation (DIC) were defined differed across studies and should be considered when comparing results. In a study from France, even though thrombotic complications were common (n=150) only four (3 per cent) were complicated by haemorrhage<sup>10</sup>.

Al-Samkari et al assessed haemorrhage rate overall as 4.8 per cent and for those with critical illness as 7.6 per cent. Within this cohort four patients with thrombotic complications experienced haemorrhage related complications. These authors mentioned that in a previous study, including critically ill ICU patients without COVID-19 and using similar defining criteria, the overall bleeding rate was 5.6 per cent<sup>11</sup>. Realistically haemorrhage events associated with overall severe inflammatory response in critically ill patients were not unique to COVID-19<sup>9</sup>. Even though fewer cases experienced thrombocytopenia and reduced fibrinogen, those were associated with major haemorrhage events.

### Viscoelastic testing

Despite ongoing guidance and recommendations to continue standard coagulation testing (prothrombin time (PT), activated partial thromboplastin time (APTT), fibrinogen and platelet count) the use of viscoelastic testing as an immediate measure of clotting ability and clot strength was increasingly valued<sup>12</sup>. Various technical methods developed by different manufacturers advanced viscoelastic testing since its original description by Herbert in 1848<sup>13</sup>. Even though these advancements ensured progress the use of different technologies made comparisons across research projects challenging<sup>14</sup>. During our review, to assess the value of viscoelastic testing in the management of COVID-19 patients, we considered methods commonly used in Australia: Rotational thromboelastometry (ROTEM) (ROTEM®, TEM International, Munich, Germany)<sup>15</sup> and thromboelastography (TEG) (TEG®, Haemonetics, Braintree, MA)<sup>16</sup>.

Reports where viscoelastic testing were used to direct assessment and therapy in COVID-19 patients presented interesting findings. Most studies evaluated relevant differences in clot formation, strength and lysis<sup>17</sup>. Hypercoagulability, described as accelerated clot formation, clot strength and reduced fibrinolysis (more common in critically ill COVID-19 patients), can potentially be predicted by early evaluation of Rotational thromboelastometry (ROTEM®)<sup>18-20</sup>. Kruse et al compared thromboelastometry and standard laboratory tests in severely ill COVID-19 patients and in others with severe sepsis. Relatively reduced fibrinolysis was observed in the COVID-19 group. These authors recommended the combination of ROTEM® measurements and D-dimer concentration to predict disease severity and direct higher intensity anticoagulation<sup>21</sup>.

Hartman et al in 2021, conducted a systematic review including 15 publications, to assess the value of thromboelastography (TEG® hemostasis analyzer) in the management of COVID-19 patients. TEG® could identify a hypercoagulable state and predict thrombotic complications in patients with COVID-19<sup>22</sup>. In a study of 21 COVID-19 patients increased fibrinogen and D-dimer levels were found with normal international normalised ratio (INR), partial thromboplastin, and platelet levels. These changes suggest an inflammatory and hematologic disease process different from traditional DIC<sup>23</sup>. The role of therapeutic anticoagulation in critically ill COVID-19 patients, in terms of the optimal pharmaceutical agent and dosing, when balancing potential haemorrhagic and thrombotic risks, remains controversial<sup>24-26</sup>. Most agree that future studies are needed targeted at subgroups of COVID-19 patients to direct coagulation therapy and ensure a definitive strategy<sup>27</sup>.

## THE IMPLICATIONS TO OTHER BLOOD PRODUCT REQUIREMENTS AND BLOOD SUPPLY

The WHO guidance on maintaining a safe and adequate blood supply during the COVID-19 pandemic outlined the primary measures for consideration as follows<sup>28</sup>: 1) mitigating the potential risk of transmission through the transfusion of blood and blood components, 2) mitigating the risk of staff and donor exposure to SARS-CoV-2, 3) mitigating the impact of reduced availability of blood donors, 4) managing demand for blood and blood products, 5) ensure undisrupted supplies of critical material and equipment, 6) communication, and 7) collection of convalescent plasma.

As a consequence of the COVID-19 pandemic, blood product requirements became uncertain while reduced donations and the absence of essential staff (due to sickness) were expected<sup>3</sup>. In Washington (USA) donor attendance fell by 10-30 per cent. However, the reduction in blood product availability was balanced by a reduction in demand subsequent to reduced elective surgery<sup>29,30</sup>. Transfusion requirements in COVID-19 patients were low (mostly observational data)<sup>3</sup>.

Australian advice included a focus on patient blood management and strategies to extend the blood supply (such as single unit transfusion). Blood donation was categorised as an essential activity throughout the pandemic including periods of lockdown. Increased social, physical and travel restrictions presented a challenge to maintain sufficiency of the blood supply. Community engagement with blood donation remained strong in Australia with approval of others, self-efficacy and trust in the blood collection agency identified as key factors underpinning decisions to donate during the pandemic<sup>31</sup>. In addition to the standard sanitisation and safety protocols already in place, modifications to blood collection processes at donor centres to protect staff and donors included wellness checks before entering the centre, restriction of non-donating visitors, provision of additional hand sanitiser, mask wearing (as per directions of government authorities), social distancing, additional cleaning protocols and the provision of public health information<sup>32</sup>. In addition, staff hubs/separate team rosters were established in testing facilities to minimise the risk of infection in the workplace and ensure trained personal would be available.

Protocols to reduce infection risk to laboratory staff in hospital blood banks varied with some countries reporting minimal change to procedures, while others introduced measures such as additional PPE, increased sanitisation and specific labelling of samples from COVID-19 patients, protocols to reduce potential aerosols

and pre-transfusion testing in biosafety cabinets<sup>33</sup>. Transfusion services at the Royal Brisbane and Women's Hospital (RBWH) changed minimally in preparation for potential COVID-19 cases. Donor availability was considered a potential concern, especially the availability of group O negative blood for emergency use. Changes were therefore introduced to allow group O positive use for male patients over 16 years of age and female patients over 50 years of age. Laboratory practices were not changed, but allowance made to not return unused blood products (when in contact with COVID-19 patients) to the blood bank inventory. In cases requiring the management of transfusion reactions, the blood product would be sent to microbiology instead of to the blood bank.

### Risk of COVID-19 transmission

The risk of transfusion transmitted infection (TTI) of SARS-CoV-2 was determined to be low. To date, there have been no reports of SARS-CoV-2 TTI. Although the blood phase of SARS-CoV-2 infection has not been fully characterised, SARS-CoV-2 infection is associated with low or absent viral RNA in blood (RNAemia)<sup>34</sup> negating the requirement for the introduction of SARS-CoV-2 RNA screening test for blood donors. From previous experience other respiratory viruses for example SARS-CoV and MERS-CoV were not transfusion-transmissible<sup>35</sup>.

Standard pre-donation screening and associated deferrals were the primary measures to maintain the safety of the blood supply during the pandemic. Further, in Australia, donors were asked three questions about their wellbeing, recent travel, and whether they had been diagnosed with COVID-19 or in close contact with someone who had. Donors with a fever were not allowed to register for their donation. On the day of donation, eligible donors completed a non-contact temperature check. Donors who returned from overseas or had been in close contact with someone diagnosed with COVID-19 were required to wait 28 days before donating blood<sup>32</sup>. A similar approach was used in New Zealand<sup>36</sup>. Vaccinated individuals in Australia were eligible to donate seven days after receiving their vaccine, provided they felt healthy and well. The National Blood Authority National Blood Supply Contingency Plan was not activated during the pandemic as relevant trigger inventory points within the plan were not reached<sup>37</sup>.

### Convalescent plasma (CPP)

During the pandemic CCP, from recovered SARS-CoV-2 infected individuals, was collected in many countries as a potential therapeutic option to combat the severity of COVID-19<sup>38</sup>. The rationale was to use plasma from those recovered in the hope that neutralising antibodies against SARS-CoV-2 could lower or eliminate the viral load in patients with COVID-19<sup>39</sup>. Clinical benefit was evident from case series<sup>40-42</sup>. CCP could be collected at different stages after recovery (>14-28 days or >28 days) using different products (apheresis plasma, whole blood-derived plasma)<sup>3</sup>.

Australian Red Cross Lifeblood commenced collection of CCP from recovered individuals in May 2020 (from men only, in line with standard risk reduction strategies for transfusion-related acute lung injury). Neutralising antibody titre was determined post donation with titre  $\geq 1:80$  suitable for clinical trial use and  $\geq 1:40$  suitable for fractionation to manufacture COVID-19 immunoglobulin. In addition to use in clinical trials, compassionate use of CCP was approved in Australia for two immunosuppressed patients with prolonged PCR positivity and symptomatic COVID-19 that were unable to mount an antibody response<sup>38</sup>. Collection of CCP ceased in Australia on 31 March 2021 due to the limited requirement, lack of ongoing evidence supporting the benefits of convalescent plasma<sup>43</sup> and the successful control of the pandemic (which impacted the need for the treatment as well as the number of individuals with antibodies to derive a suitable product). In addition, subsequent to the vaccine rollout and strong antibody responses, passive antibody products could be derived from vaccinated individuals should the need arise<sup>44</sup>.

## PERIOPERATIVE IMMUNE MODULATION

While previously perhaps underappreciated since the start of the current COVID-19 pandemic the study of immunology became truly relevant and important. The immune system is however complex and modulated by many factors during surgery, including anaesthesia and transfusion<sup>45</sup>. Even though transfusion ensures the survival of many trauma patients, subsequent adverse outcomes, for example infection, increasingly affect patient outcomes. Trauma accounted for more than five million deaths per year internationally (WHO)<sup>46</sup>. Postoperative infection, sepsis and death correlated with changes to IL-6, TNF- $\alpha$ , monocyte IL-12 production and monocyte HLA-DR expression<sup>47</sup>. Altered TNF- $\alpha$ , monocyte surface mCD14 and HLA-DR expression were described as immunoparalysis ("a hallmark of altered immune status in patients with a systemic inflammatory response syndrome")<sup>48</sup>. Even though the exact mechanism remains unclear<sup>49,50</sup>, increased nosocomial infections and organ impairment, reduced overall survival, cancer recurrence and poorer outcomes (following surgery for lung and bowel cancer), may be the consequence of immune modulation<sup>51,52</sup>. To ensure homeostasis, a delicate balance between pro- and anti-inflammatory activation is required. Dysregulation of the inflammatory response can result in ongoing inflammation or immune suppression associated with increased

risk of post-operative sepsis and multiorgan dysfunction<sup>53</sup>. The type of anaesthetic may affect the cellular immune response, reduce systemic infection rates<sup>54</sup> and improve prognosis<sup>55</sup>. Other perioperative medications for example dexamethasone<sup>54</sup> and antimicrobial drugs (a large and growing field of study)<sup>56</sup> are important. Macrolides, tetracyclines, polymyxins, sulfones, antifungal, antiviral and antiparasitic drugs are among those with known immune modulatory effects<sup>56</sup>. The degree of immune modulation also correlates with the extent of the surgical trauma, patient comorbidities<sup>57</sup>, the type of surgery and disease process (for example, cancer surgery), coexisting infection, impaired nutritional status<sup>58</sup>, pain, psychological stress<sup>59</sup>, surgical inflammation<sup>60</sup>, hypotension and hypothermia<sup>61</sup>.

## TRIM

Transfusion related immune modulation (TRIM) describes a delayed immune response following ABT<sup>45</sup>, associated with postoperative infection risk, cancer recurrence and other adverse outcomes<sup>62</sup>. Since the 1970s many aimed to confirm the mechanism of TRIM and various theories were studied. Alterations of the immune system after trauma and surgery result in activation of antigen-presenting cells such as monocytes and dendritic cells<sup>63</sup> as well as HLA-DR expression rate and the subsequent susceptibility to postoperative infection<sup>64</sup>.

It may be possible to reduce immune modulation and subsequent immunological suppression by using intra-operative cell salvage (ICS) instead of allogeneic blood transfusion (ABT)<sup>65,66</sup>. During a recent prospective observational study at the Royal Brisbane and Women's Hospital (RBWH) an in vitro model was used to evaluate immune competence (2020) following ABT or ICS exposure<sup>66</sup>. Intracellular cytokine production, co-stimulatory and adhesion molecule expression on dendritic cells and monocytes and the modulation of the overall leukocyte response were assessed. Exposure to both ABT and ICS suppressed dendritic cell and monocyte function. This suppression was however less marked following ICS, confirming improved immune competence.

## INTRAOPERATIVE CELL SALVAGE

ICS is a blood conservation technique that allows extravasated blood to be collected from the surgical field, anticoagulated, processed and returned to the patient<sup>67</sup>. The processing of blood through a sophisticated centrifuge technique and followed by filtering ensures the removal of bacteria, debris, clotting factors, heparin, free haemoglobin, fat, malignant cells<sup>68</sup>, bone chips, cement<sup>69</sup>, irrigation solution, coagulants, platelets, fibrinogen degradation products, plasma and some activated factors<sup>70,71</sup>. Advances in technology and techniques<sup>67</sup> that improved the safety of ICS included the first use of transfusion with a "syringe", "Gravitator" and "impellor" by John Blundell (late 1800s)<sup>72,73</sup>, the first successful autotransfusion procedure during surgery (John Duncan, 1886)<sup>74</sup>, sodium citrate described by Lewisohn (1917)<sup>75</sup> and Acid-Citrate-Dextrose (ACD) as anticoagulant (1943) by Loutit and Mollison<sup>76</sup> and the first commercially available autotransfusion system the "Bentley Autotransfuser" (Bentley Laboratories, Irvine, California, USA, 1970)<sup>71</sup>. To ensure salvaged blood is clean and safe for reinfusion, that is, free from infection, clot and debris, modern ICS devices employ important technological processing advances and filtering techniques. Filter technology developed from the earlier use of steel wool<sup>77</sup>, muslin gauze and sterile surgical sponges<sup>78</sup>, to disposable sterile filters (1970s)<sup>79</sup>, through to more advanced mesh filters<sup>80</sup> (similar to those used during the production of donated blood today). The risk of transmission of bacterial contamination during ICS is now greatly reduced, especially in the presence of a leucodepletion filter<sup>81</sup>.

Though favoured by specific surgical sub-specialties including vascular, major orthopaedic, urology and obstetrics and gynaecology, ICS is recommended for most surgical procedures with expected blood loss of >500ml or 20 per cent of the patient's estimated blood volume<sup>82</sup>. Traditional contraindications no longer apply. Relevant considerations include the risk of bacterial contamination (for example, during bowel perforation in trauma) and cases for cancer surgery where dissemination of malignant cells may be of concern. More research is required to characterise the exact risk relevant to these considerations.

### ICS procedure at the Royal Brisbane and Women's Hospital (RBWH)

At the RBWH ICS is part of the "major haemorrhage transfusion protocol" and a representative from the anaesthesia department is included in the working party charged with ongoing protocol updates. A member of the ICS team holds a dedicated deck phone within office hours and is thereafter available on call for 24 hours, every day of the year. To activate the ICS service a simple phone call is made. All the members of the ICS team are trained and experienced, involved in ongoing research projects, follows the National Blood Authority guidance, local protocols and receive ongoing education through conferences and online learning material.

Historically blood samples (from the ICS product) were sent to enable FBC and blood cultures to ensure governance compliance. These are no longer required as new technology within current ICS devices enable real time haemoglobin measurement of processed cell salvage product. We found that blood cultures resulted in many

false positive results with little added benefit. In line with microbiology advice this practise ceased in 2015. Serial testing (patient samples) required for standard clinical management during cases where major blood loss occur are done independent of the use of ICS.

### The standard ICS procedure

At the start of the surgery, the sterile ICS suction tubing is handed to the scrubbed nurse in theatre, in a sterile fashion, who then returns the vacuum port for connection onto the relevant port on the ICS reservoir. When preparing the anticoagulant solution, commonly 30,000 IU of heparin is introduced to one litre of intravenous (IV) normal saline (0.9 per cent NaCl). When heparin is contraindicated Acid Citrate Dextrose (ACD) can be used instead. It is important to consider that each manufacturer and autotransfusion device may require different wash program settings when using ACD instead of heparin. Thereafter, the circuit (ICS reservoir and the collection set) is primed with anticoagulant (according to the specific manufacturer's guidance) before the collection of salvaged blood can proceed.

Most manufacturers provide separate consumables to allow setup for collection and for processing (if required). Suction pressure is preferably kept below <150 mmHg to reduce the amount of red blood cell haemolysis. Once the collection of salvaged blood reach 500 ml (or sooner if deemed clinically necessary), the autotransfusionist would start processing collected blood. Collected salvaged blood within a re-infusion bag, with an applicable label, is provided to the anaesthetic team for re-infusion.

The involvement of a well-trained autotransfusionist is essential to: Manage specific autotransfusion device settings (relevant to procedure type), identify potential contraindications and prevent the unplanned aspiration of solutions not suitable for IV use, process salvaged blood with ongoing consideration of anticoagulant supply relevant to the amount of blood lost and advocate for the use of an applicable filter for reinfusion (relevant to the type of surgery).

## THE IMPLICATIONS TO AN INTRAOPERATIVE CELL SALVAGE SERVICE DURING COVID-19

During the COVID-19 pandemic ICS became a viable option: to provide an alternative blood supply with potential immunological benefits. The incidence of haemorrhage during surgery in COVID-19 positive patients did not increase substantially<sup>9</sup>. It was therefore unlikely that a cell salvage service would be overwhelmed as a consequence. It is however important to consider that the increased burden relevant to personal protection equipment and infection prevention precautions would also apply to cell salvage staff.

ICS may also, in patients with confirmed or suspected COVID-19 disease, provide an immediate blood supply during urgent cases across a variety of sub-specialties: vascular, cardiothoracic, obstetrics and gynaecology, orthopaedic, spinal, general, urology and plastic surgery<sup>83</sup>. New risks and considerations therefore compelled some changes to our existing ICS protocol. Considering additional staffing and equipment would potentially be exposed to SARS-CoV-2, ICS should only be used if essential, where clinically indicated and when significant haemorrhage is expected. The requirement of ICS should be discussed with the anaesthetist and surgeon responsible for patient care.

### COVID-19 specific ICS equipment

The ICS machine (autotransfusion device) should be stored outside and only taken into the COVID-19 theatre when required. All ICS re-usable equipment should be cleaned with the specific product recommended by local infection control policy for cleaning of medical equipment (for example CLINEL® wipes), before and after use, similar to other essential equipment used in theatre (for example the ultrasound machine). All consumables should be used according to the relevant manufacturer's guidance and after use discarded into clinical waste bags or bins, like other used intravenous tubing and giving sets. It is recommended that autotransfusionists use a checklist (see Table 1), with commonly used items, to prepare before the start of each case. These items can be kept on a separate trolley, available to take into the room once ICS processing is required. Ensuring all the required items are taken into theatre, when the autotransfusionists enters, will reduce the number of times equipment gets transferred or requested into the COVID-19 theatre. An ICS consumable trolley, with backup equipment, should be kept outside the COVID-19 theatre and required items handed into the theatre.

### COVID-19 specific autotransfusionist role

The autotransfusionist (trained ICS staff member) should only be inside the COVID-19 theatre during essential periods and use full PPE donning and doffing precautions, similar to those conducting the anaesthetic. It is preferable to minimise the number of times PPE is donned and doffed. Therefore, it is recommended to enter once required and stay inside the room until the processing of blood is complete, if possible. It is often possible to complete this process (from collection until ICS blood for re-infusion is provided to the anaesthetist) at a

distance (1-1.5 m) from the patient. At the end of the case, the autotransfusionist would clean and discard used items and discarded blood, similar to all other equipment and products used in the COVID-19 theatre.

**Table 1. Consumable checklist: The ICS COVID-19 case trolley**

Consumables for collection:	Consumables for processing:
1000 ml Normal Saline (0.9%)	2 x 1000 ml Normal Saline (0.9%)
ICS reservoir and collection set	Centrifuge/bowl set
ICS pack with sterile suction tubing	Cell salvage reinfusion bag
	Appropriate cell salvage blood filter, that is, standard filter or leucodepletion (LCD) filter applicable to the specific surgical procedure
Label for heparin solution	Label for salvaged/processed blood product
5 ml syringe	Paper autotransfusion document
Drawing up needle	Pen

## ADDITIONAL INTERESTING FACTS

Associations between blood group type and infectious diseases such as tuberculosis, malaria, norovirus, retrovirus, chikungunya virus and *Helicobacter pylori* have previously been described<sup>84</sup>. Analysis of ABO blood group and COVID-19 disease severity indicated group O may be associated with a lower risk of SARS-CoV-2 infection and group A may be associated with a higher risk of SARS-CoV-2 infection and severe disease<sup>85</sup>. While further research is required to confirm these outcomes and to define mechanisms, it is important to note that ABO blood group may play a role in SARS-CoV-2 infection and COVID-19 pathogenesis.

## CONCLUSION

COVID-19 may be associated with coagulation and fibrin metabolism abnormalities in infected patients. Anecdotal meta-analysis evidence suggests that higher D-dimer and fibrin degradation values and shorter thrombin times were associated with poorer prognosis and increased mortality; however, more research is required to validate haematological biomarkers for prognosticating COVID-19 severity. Anaemia and thrombocytopenia were uncommon but if present associated with worse outcomes. Blood donation was categorised as an essential activity throughout the pandemic including periods of lockdown. Increased social, physical and travel restrictions presented a challenge to maintain sufficiency of the blood supply but this was largely offset by changes in elective surgery.

Donating and receiving allogeneic blood products during the COVID-19 pandemic is associated with minimal risk. Standardised protocols using viscoelastic testing to guide coagulation and platelet therapy in COVID-19 are not yet validated and there are no contraindications to the use of ICS during COVID-19 cases.

## ACKNOWLEDGEMENTS

The authors would like to acknowledge information received towards this publication from: The RBWH ICS group (David Cullingham, Trisha Bushell, Warick Fawkes, Russini Stapleton, Yves Long, Barry Elliott, Cassie Hohnke, Lee Elliott, Kym Webster, Peter Freeman, Vicki Swaine (Director Anaesthetic Healthcare Practitioners)) and Sue Williams (supervising scientist, pathology Queensland).

## REFERENCES

1. Wise J. A third of covid-19 patients admitted to uk hospitals die. *BMJ*. 2020; 369(m1794).
2. WHO. Who coronavirus (covid-19) dashboard [Internet]. WHO; 2021. Available from: <https://covid19.who.int/>.
3. Stanworth SJ, New HV, Apolseth TO, Brunskill S, Cardigan R, Doree C, et al. Effects of the covid-19 pandemic on supply and use of blood for transfusion. *The Lancet Haematology*. 2020.
4. Han H, Yang L, Liu R, Liu F, Wu K-I, Li J, et al. Prominent changes in blood coagulation of patients with SARS-CoV-2 infection. *Clinical Chemistry and Laboratory Medicine (Clin Chem Lab Med)*. 2020; Jun 25;58(7):1116-1120.
5. Tang N, Li D, Wang X, Sun Z. Abnormal coagulation parameters are associated with poor prognosis in patients with novel coronavirus pneumonia. *Journal of thrombosis and haemostasis (J Thromb Haemost)*. 2020; Apr;18(4):844-7.
6. Baron DM, Franchini M, Goobie SM, Javidrooz M, Klein AA, Lasocki S, et al. Patient blood management during the covid-19 pandemic: A narrative review. *Anaesthesia*. 2020; 75(8):1105-13.

7. Lin J, Yan H, Chen H, He C, Lin C, He H, et al. Covid-19 and coagulation dysfunction in adults: A systematic review and meta-analysis. *Journal of medical virology (J Med Virol)*. 2021; 93(2):934-44.
8. Malas MB, Naazie IN, Elsayed N, Mathlouthi A, Marmor R, Clary B. Thromboembolism risk of covid-19 is high and associated with a higher risk of mortality: A systematic review and meta-analysis. *EClinicalMedicine*. 2020; Dec;29.
9. Al-Samkari H, Karp Leaf RS, Dzik WH, Carlson JC, Fogerty AE, Waheed A, et al. Covid-19 and coagulation: Bleeding and thrombotic manifestations of SARS-CoV-2 infection. *Blood*. 2020; 136(4):489-500.
10. Helms J, Tacquard C, Severac F, Leonard-Lorant I, Ohana M, Delabranche X, et al. High risk of thrombosis in patients with severe SARS-CoV-2 infection: A multicenter prospective cohort study. *Intensive care medicine (Intensive Care Med)*. 2020; Jun;46(6):1089-98.
11. Lauzier F, Arnold DM, Rabbat C, Heels-Ansdell D, Zarychanski R, Dodek P, et al. Risk factors and impact of major bleeding in critically ill patients receiving heparin thromboprophylaxis. *Intensive care medicine (Intensive Care Med)*. 2013; Dec;39(12):2135-43.
12. Spahn DR, Bouillon B, Cerny V, Coats TJ, Duranteau J, Fernández-Mondéjar E, et al. Management of bleeding and coagulopathy following major trauma: An updated european guideline. *Critical care (Crit Care)*. 2013; Apr 19;17:R76. (2):1-45.
13. Whiting D, DiNardo JA. Teg and rotem: Technology and clinical applications. *American journal of hematology (Am J Hematol)*. 2014; Feb;89(2):228-32.
14. Carl T, Wool GD. Basic principles of viscoelastic testing. *Transfusion*. 2020; 60(S6):S1-S9.
15. Görlinger K, Dirkmann D, Hanke A. Trauma induced coagulopathy: Rotational thromboelastometry (rotem®). Gonzalez E, Moore HB, Moore EE, editors. [Internet] [https://www.researchgate.net/publication/301484623\\_Rotational\\_thromboelastometry\\_ROTETR](https://www.researchgate.net/publication/301484623_Rotational_thromboelastometry_ROTETR): Springer International Publishing; 2016.
16. Neal MD, Moore EE, Walsh M, Thomas S, Callcut RA, Kornblith LZ, et al. A comparison between the teg 6s and teg 5000 analyzers to assess coagulation in trauma patients. *The journal of trauma and acute care surgery (J Trauma Acute Care Surg)*. 2020; Feb;88(2):279-85.
17. American Society of Hematology. Covid-19 and viscoelastic hemostasis assays: Frequently asked questions [Internet]. 2021 [updated February 25,]. Available from: <https://www.hematology.org/covid-19/covid-19-and-ve>.
18. Almskog LM, Wikman A, Svensson J, Wanecek M, Bottai M, van der Linden J, et al. Rotational thromboelastometry results are associated with care level in covid-19. *Journal of thrombosis and thrombolysis (J Thromb Thrombolysis)*. 2021; 51(2):437-45.
19. Boss K, Kribben A, Tyczynski B. Pathological findings in rotation thromboelastometry associated with thromboembolic events in covid-19 patients. *Thrombosis Journal (Thromb J)*. 2021; Feb 11;19(1):1-7.
20. Mitrovic M, Sabljic N, Cvetkovic Z, Pantic N, Zivkovic Dakic A, Bukumiric Z, et al. Rotational thromboelastometry (rotem) profiling of covid-19 patients. *Platelets*. 2021; Jul 4;32(5):690-6.
21. Kruse JM, Magomedov A, Kurreck A, Münch FH, Koerner R, Kamhieh-Milz J, et al. Thromboembolic complications in critically ill covid-19 patients are associated with impaired fibrinolysis. *Critical care (Crit Care)*. 2020; Dec 7;24(1):676.
22. Hartmann J, Ergang A, Mason D, Dias JD. The role of teg analysis in patients with covid-19-associated coagulopathy: A systematic review. *Diagnostics*. 2021; Jan 26;11(2):172.
23. Mortus JR, Manek SE, Brubaker LS, Loor M, Cruz MA, Trautner BW, et al. Thromboelastographic results and hypercoagulability syndrome in patients with coronavirus disease 2019 who are critically ill. *JAMA Network Open (JAMA Netw Open)*. 2020; Jun 1;3(6):e2011192-e.
24. Bikdeli B, Madhavan MV, Jimenez D, Chuich T, Dreyfus I, Riggin E, et al. Covid-19 and thrombotic or thromboembolic disease: Implications for prevention, antithrombotic therapy, and follow-up: Jacc state-of-the-art review. *Journal of the American college of cardiology (J Am Coll Cardiol)*. 2020; Jun 16;75(23):2950-73.
25. Obi AT, Barnes GD, Wakefield TW, Brown S, Eliason JL, Arndt E, et al. Practical diagnosis and treatment of suspected venous thromboembolism during covid-19 pandemic. *Journal of Vascular Surgery: Venous and Lymphatic Disorders (J Vasc Surg Venous Lymphat Disord)*. 2020; Jul;8(4):526-34.
26. Cattaneo M, Bertinato EM, Bircocchi S, Brizio C, Malavolta D, Manzoni M, et al. Pulmonary embolism or pulmonary thrombosis in covid-19? Is the recommendation to use high-dose heparin for thromboprophylaxis justified? *Thrombosis and haemostasis (Thromb Haemost)*. 2020; Aug;120(08):1230-2.
27. van Veenendaal N, Scheeren TW, Meijer K, van der Voort PH. Rotational thromboelastometry to assess hypercoagulability in covid-19 patients. *Thrombosis Research (Thromb Res)*. 2020; 196:379-81.
28. World Health Organization. Guidance on maintaining a safe and adequate blood supply during the coronavirus disease 2019 (covid-19) pandemic and on the collection of covid-19 convalescent plasma: Interim guidance. Geneva [Internet] <https://apps.who.int/iris/handle/10665/333182>: World Health Organization,2020 Jul 10. 1-6p.
29. Cai X, Ren M, Chen F, Li L, Lei H, Wang X. Blood transfusion during the covid-19 outbreak. *Blood Transfusion (Blood Transfus)*. 2020; Mar;18(2):79-82.
30. Fan BE, Ong KH, Chan SSW, Young BE, Chong VCL, Chen SPC, et al. Blood and blood product use during covid-19 infection. *American journal of hematology (Am J Hematol)*. 2020; Jul;95(7):E158-E60.
31. Masser BM, Hyde MK, Ferguson E. Exploring predictors of australian community members' blood donation intentions and blood donation-related behavior during the covid-19 pandemic. *Transfusion*. 2020; Dec;60(12):2907-17.
32. Australian Red Cross Lifeblood. Coronavirus information [Internet]. 2021 [updated 28 Jul 2021].
33. Yazer MH, Bueno JL. Vox sanguinis international forum on hospital transfusion services' response to covid-19. *Vox Sanguinis*. 2020.
34. Kiely P, Hoard VC, Seed CR, Gosbell IB. Severe acute respiratory syndrome coronavirus-2: Implications for blood safety and sufficiency. *Vox Sanguinis*. 2021; 116(2):155-66.
35. Australian Red Cross Lifeblood. Coronavirus disease (covid-19) and the impact on the blood supply [Internet]. 2020. Available from: <https://transfusion.com.au/coronavirus>.

36. NZBlood. Important information for blood donors regarding covid-19 (novel coronavirus) [Internet]. 2021 [updated 2020 Mar 23]. Available from: <https://www.nzblood.co.nz/news/2020/important-information-for-blood-donors-regarding-covid-19-novel-coronavirus>.
37. National Blood Authority. Response to novel coronavirus [Internet]. Commonwealth of Australia; 2021 [updated unknown]. Available from: <https://www.blood.gov.au/response-novel-coronavirus-4>.
38. Al-Riyami AZ, Burnouf T, Yazer M, Triulzi D, Kumaş LT, Sağdur L, et al. International forum on the collection and use of covid-19 convalescent plasma: Responses. *Vox Sanguinis*. 2021 (Online ahead of print).
39. Maxmen A. How blood from coronavirus survivors might save lives. *Nature*. 2020; Apr;580(7801):16-7.
40. Duan K, Liu B, Li C, Zhang H, Yu T, Qu J, et al. Effectiveness of convalescent plasma therapy in severe covid-19 patients. *Proceedings of the National Academy of Sciences (Proc Natl Acad Sci U S A)*. 2020; Apr 28;117(17):9490-6.
41. Dzik S. Covid-19 convalescent plasma: Now is the time for better science. *Transfusion medicine reviews (Transfus Med Rev)*. 2020; Jul;34(3):141-4.
42. Roback JD, Guarnier J. Convalescent plasma to treat covid-19: Possibilities and challenges. *Jama*. 2020; 323(16):1561-2.
43. Wood EM, Estcourt LJ, McQuilten ZK. How should we use convalescent plasma therapies for the management of covid-19? *Blood*. 2021; Mar 25;137(12):1573-81.
44. Australian Red Cross Lifeblood. Health professionals: Coronavirus disease (covid-19) and the impact on the blood supply [Internet]. Australian Red Cross Lifeblood; 2020 [updated 12 May, 2021].
45. Hellings S, Blajchman MA. Transfusion-related immunosuppression. *Anaesthesia & Intensive Care Medicine (AIC)*. 2009; 10(5):231-4.
46. WHO. Injuries and violence the facts, who library cataloguing-in-publication data [Internet]. 2014. Available from: [https://apps.who.int/iris/bitstream/handle/10665/149798/9789241508018\\_eng.pdf](https://apps.who.int/iris/bitstream/handle/10665/149798/9789241508018_eng.pdf).
47. Majetschak M, Flach R, Kreuzfelder E, Jennissen V, Heukamp T, Neudeck F, et al. The extent of traumatic damage determines a graded depression of the endotoxin responsiveness of peripheral blood mononuclear cells from patients with blunt injuries. *Critical care medicine (Crit Care Med)*. 1999; Feb;27(2):313-8.
48. Kim OY, Monsel A, Bertrand M, Coriat P, Cavillon J-M, Adib-Conquy M. Differential down-regulation of hla-dr on monocyte subpopulations during systemic inflammation. *Critical care (Crit Care)*. 2010; 14(2):R61.
49. Ahlers O, Nachtigall I, Lenze J, Goldmann A, Schulte E, Höhne C, et al. Intraoperative thoracic epidural anaesthesia attenuates stress-induced immunosuppression in patients undergoing major abdominal surgery. *British journal of anaesthesia (Br J Anaesth)*. 2008; Dec;101(6):781-7.
50. Papadima A, Boutsikou M, Lagoudianakis EE, Katakis A, Konstadoulakis M, Georgiou L, et al. Lymphocyte apoptosis after major abdominal surgery is not influenced by anesthetic technique: A comparative study of general anesthesia versus combined general and epidural analgesia. *J Clin Anesth*. 2009; 21(6):414-21.
51. O'Dwyer MJ, Owen HC, Torrance HD. The perioperative immune response. *Curr Opin Crit Care*. 2015; 21(4):336-42.
52. Chan JC, Chan DL, Diakos CI, Engel A, Pavlakis N, Gill A, et al. The lymphocyte-to-monocyte ratio is a superior predictor of overall survival in comparison to established biomarkers of resectable colorectal cancer. *Annals of surgery (Ann Surg)*. 2017; Mar;265(3):539-46.
53. Gentile LF, Cuenca AG, Efron PA, Ang D, McKinley BA, Moldawer LL, et al. Persistent inflammation and immunosuppression: A common syndrome and new horizon for surgical intensive care. *The journal of trauma and acute care surgery (J Trauma Acute Care Surg)*. 2012; Jun;72(6):1491-501.
54. Torrance HD, Pearse RM, O'Dwyer MJ. Does major surgery induce immune suppression and increase the risk of postoperative infection? *Current opinion in anaesthesiology (Curr Opin Anaesthesiol)*. 2016; Jun;29(3):376-83.
55. Biki B, Mascha E, Moriarty DC, Fitzpatrick JM, Sessler DI, Buggy DJ. Anesthetic technique for radical prostatectomy surgery affects cancer recurrence: A retrospective analysis. *Anesthesiology*. 2008; Aug;109(2):180-7.
56. Ruh C, Banjade R, Mandadi S, Marr C, Sumon Z, Crane JK. Immunomodulatory effects of antimicrobial drugs. *Immunological investigations (Immunol Invest)*. 2017; Nov;46(8):847-63.
57. Hannaman MJ, Ertl MJ. Patients with immunodeficiency. *Medical Clinics (Med Clin North Am)*. 2013; Nov;97(6):1139-59.
58. Dąbrowska AM, Słotwiński R. The immune response to surgery and infection. *Central-European journal of immunology (Cent Eur J Immunol)*. 2014; 39(4):532-7.
59. Glaser R, Rabin B, Chesney M, Cohen S, Natelson B. Stress-induced immunomodulation: Implications for infectious diseases? *Jama*. 1999; 281(24):2268-70.
60. Volk H-D. Immunodepression in the surgical patient and increased susceptibility to infection. *Critical care (Crit Care)*. 2002; 6(4):279-81.
61. Kurosawa S. Anesthesia in patients with cancer disorders. *Current Opinion in Anesthesiology (Curr Opin Anaesthesiol)*. 2012; 25(3):376-84.
62. Vamvakas EC, Blajchman MA. Transfusion-related immunomodulation (trim): An update. *Blood reviews (Blood Rev)*. 2007; 21(6):327-48.
63. Bianchi ME, Manfredi AA. High-mobility group box 1 (hmgb1) protein at the crossroads between innate and adaptive immunity. *Immunological reviews (Immunol Rev)*. 2007; 220(1):35-46.
64. Wakefield C, Carey P, Foulds S, Monson J, Guillou P. Changes in major histocompatibility complex class ii expression in monocytes and t cells of patients developing infection after surgery. *Journal of British Surgery (Br J Surg)*. 1993; 80(2):205-9.
65. Carless PA, Henry DA, Moxey AJ, O'Connell D, Brown T, Fergusson DA. Cell salvage for minimising perioperative allogeneic blood transfusion. *Cochrane Database Syst Rev*. 2010; Apr 14(4):Cd001888.
66. Roets M, Sturgess DJ, Obeysekera MP, Tran TV, Wyssusek KH, Punnesseril JEJ, et al. Intraoperative cell salvage as an alternative to allogeneic (donated) blood transfusion: A prospective observational evaluation of the immune response profile. *Cell Transplantation (Cell Transplant)*. 2020; 29:0963689720966265.

67. Roets M, Sturgess DJ, Wyssusek K, van Zundert AA. Intraoperative cell salvage: A technology built upon the failures, fads and fashions of blood transfusion. *Anaesthesia and intensive care (Anaesth Intensive Care)*. 2019; 47(3\_suppl):17-30.
68. König G, Waters JH. Washing and filtering of cell-salvaged blood – does it make autotransfusion safer? *Transfusion alternatives in transfusion medicine (Transfus Altern Transfus Med)*. 2012; 12(3-4):78-87.
69. Turner R, Steady H. Cell washing in orthopedic surgery. Hauer JM, editor. New York: Elsevier/North-Holland; 1981.
70. Stillman RM, Wrezlewicz WW, Stanczewski B, Chapa L, Fox MJ, Sawyer PN. The haematological hazards of autotransfusion. *British Journal of Surgery (Br J Surg)*. 1976; 63(8):651-4.
71. Thurer RL, Hauer JM. Autotransfusion and blood conservation. *Current Problems in Surgery (Curr Probl Surg)*. 1982; 19(3):97-156.
72. Rudmann SV. *Textbook of blood banking and transfusion medicine 2*, editor. Philadelphia: Elsevier Saunders; 2005 18-02-2005
73. Blundell J. *Researches physiological and pathological*. London: E. Cox & Son 1824.
74. Duncan J. On reinfusion of blood in primary and other amputations. *The British Medical Journal (Br Med J)*. 1886; 1:192-3.
75. Lewisohn R. Modern methods of blood transfusion. *Journal of the American Medical Association (J Am Med Assoc)*. 1917; 68(11):826-8.
76. Freedman J. Transfusion – whence and why. *Transfusion and Apheresis Science (Transfus Apher Sci)*. 2014; 50(1):5-9.
77. Pineda AA, Valbonesi M. Intraoperative blood salvage. *Baillière's Clinical Haematology (Baillieres Clin Haematol)*. 1990; 3(2):385-403.
78. Wilson J, Taswell H. Autotransfusion: Historical review and preliminary report on a new method. *Mayo Clinic Proceedings (Mayo Clin Proc)* [Internet]1968. p. 26-35.
79. Klebanoff G, Phillips J, Evans W. Use of a disposable autotransfusion unit under varying conditions of contamination. Preliminary report. *American Journal of Surgery (Am J Surg)*. 1970; 120(3):351-4.
80. Wright CB, Solis RT. Microaggregation in canine autotransfusion. *The American Journal of Surgery (Am J Surg)*. 1973; 126(1):25-9.
81. Waters JH, Tuohy MJ, Hobson DF, Procop G. Bacterial reduction by cell salvage washing and leukocyte depletion filtration. *Anesthesiology*. 2003; 99(3):652-5.
82. Klein A, Bailey C, Charlton A, Evans E, Guckian-Fisher M, McCrossan R, et al. Association of anaesthetists guidelines: Cell salvage for peri-operative blood conservation 2018. *Anaesthesia*. 2018; 73(9):1141-50.
83. Willington L, Roets M. Intraoperative cell salvage. *Australasian Anaesthesia*. 2017; (2017):135-43.
84. Liunbruno GM, Franchini M. Beyond immunohaematology: The role of the abo blood group in human diseases. *Blood Transfusion (Blood Transfus)*. 2013; 11(4):491.
85. Goel R, et al (2021). "ABO blood group and COVID-19: a review on behalf of the ISBT COVID-19 working group." *Vox Sanguinis*.

## Direct acting oral anticoagulants – pharmacology and perioperative considerations

### Kate Drummond MBBS FANZCA MMed

Senior Staff Specialist, Royal Adelaide Hospital, South Australia; Specialist Anaesthetist, Pulse Anaesthetics, Adelaide, South Australia; Clinical Senior Lecturer, University of Adelaide Medical School, Faculty of Health and Medical Sciences, Adelaide, South Australia

Dr Kate Drummond is a staff specialist anaesthetist at the Royal Adelaide Hospital and works in private practice with Pulse Anaesthesia. She has a master's degree in perioperative medicine and her special areas of interest include perioperative blood management with a focus on blood conservation and cardiothoracic anaesthesia and transoesophageal echocardiography.

### INTRODUCTION

Originally known as *novel* oral anticoagulants, dabigatran, rivaroxaban and apixaban have over the past 10 years become the anticoagulant of choice for several clinical conditions. These now not-so-novel drugs are well tolerated and often preferred to warfarin due to their lower risk of bleeding in the community, stable pharmacokinetics and ease of use for both patients and prescribers.

Better termed *direct* acting oral anticoagulants (DOACs), as this describes their mechanism of action, these drugs present both advantages and challenges for the perioperative clinician. This article reviews the pharmacology of, current indications for, and the perioperative management of the three DOACs available in Australia.

### PHARMACOLOGY

#### Dabigatran – Direct thrombin inhibitor

Dabigatran etexilate is a potent, competitive, and reversible inhibitor of both free and clot-bound thrombin (factor IIa)<sup>1,2</sup>. Thrombin plays a pivotal role in clot formation. Insufficient thrombin activity will lead to bleeding, whereas excess thrombin activity will result in thrombosis<sup>3</sup>. Thrombin, produced by cleaving prothrombin, activates clot formation by activating factors V, VII and XI, by catalysing the conversion of fibrinogen to fibrin; and by stimulating platelet aggregation. All these functions are inhibited by dabigatran<sup>1,2,4</sup>. It is formulated as a prodrug that is hydrolysed into active dabigatran by non-specific microsomal carboxylesterases. Active dabigatran binds to the thrombin molecule's active site which rapidly prevents clot formation.

Importantly, unlike warfarin, dabigatran has minimal drug interactions as it does not use the cytochrome P450 enzyme pathway for elimination. However, dabigatran levels may be increased by P-glycoprotein (P-gp) inhibitors (for example, amiodarone, clarithromycin, and verapamil)<sup>4</sup>. It has poor oral bioavailability, hence its formulation as a prodrug in a non-crushable capsule. It has four active metabolites and is predominantly renally cleared (see Table 1)<sup>1</sup>. Dose adjustment is required in the elderly and patients with renal impairment but not with hepatic impairment. Dabigatran can be removed with haemodialysis.

#### Apixaban and rivaroxaban – Factor Xa inhibitors

Both apixaban and rivaroxaban are direct inhibitors of free and clot bound factor Xa. Factor Xa is essential in generating thrombin from prothrombin. Factor Xa can be activated by both the intrinsic and extrinsic pathways and, once activated, binds with factor Va on the surface of platelets to form prothrombinase. Prothrombinase is responsible for cleaving prothrombin into thrombin. Each molecule of factor Xa generates around 1000 molecules of thrombin which then convert fibrinogen to fibrin<sup>3</sup>.

Factor Xa inhibitors bind selectively to factor Xa and unlike heparin do not need antithrombin to generate their pharmacological effect. Both apixaban and rivaroxaban are active drugs with good oral bioavailability and high plasma protein binding. They are both renally and faecally excreted and are less likely to accumulate in renal failure compared with dabigatran (see Table 1)<sup>1</sup>.

**Table 1. Pharmacokinetics of DOACs available in Australia<sup>1,3,5</sup>**

		DOACs		
		Dabigatran	Rivaroxaban	Apixaban
Pharmacokinetics	<b>Brand name</b>	Pradaxa	Xarelto	Eliquis
	<b>Action</b>	IIa inhibition	Xa inhibition	Xa inhibition
	<b>Bioavailability</b>	3–7%	60% without food 100% with food	50–60%
	<b>Peak plasma level</b>	2 hours	2–4 hours	1–4 hours
	<b>Half life</b>	12–14 hours	<b>Young:</b> 5–9 hours <b>Elderly:</b> 11–13 hours	8–15 hours
	<b>Renal excretion</b>	80%	35%	25%
	<b>Protein binding</b>	35%	>90%	87%
	<b>Interactions with Pgp inhibitors</b>	++	+	+
	<b>Interaction with CYP3A4</b>	-	+	+

## APPROVED INDICATIONS

There are three main indications for the use of DOACs. Firstly, prevention of stroke in patients with non-valvular atrial fibrillation (AF); secondly prophylaxis of venous thrombosis after orthopaedic surgery; and thirdly treatment or prevention of recurrence of deep venous thrombosis (DVT) and/or pulmonary embolus (PE) (see Table 2)<sup>5</sup>.

Additionally, more recently, rivaroxaban has been TGA-approved in Australia for the prevention of major cardiovascular events (a composite of stroke, myocardial infarction and cardiovascular death) in patients with coronary artery disease (CAD) or peripheral vascular disease (PVD) but is not currently available on the PBS for this fourth indication (see Table 2)<sup>6</sup>.

Non-valvular AF is the most common indication for DOACs<sup>7</sup>. In this group, dabigatran has been shown to be superior to warfarin in preventing stroke with an overall lower rate of bleeding complications, although gastrointestinal (GI) bleeding rates were slightly higher. Rivaroxaban is non-inferior to warfarin at preventing strokes and has reduced rates of intracranial and fatal haemorrhage when compared with warfarin. Rivaroxaban, however, also has a higher rate of GI bleeding when compared with warfarin<sup>5,7,8</sup>. Apixaban is also superior to warfarin at preventing strokes and has a reduced rate of bleeding complications compared with other DOACs<sup>8</sup>.

All three DOACs have been shown to be superior to enoxaparin (40mg/day) at preventing venous thromboembolism (VTE) without an increase in bleeding complications after orthopaedic surgery, although they do not decrease mortality<sup>7,9</sup>. Rivaroxaban may have slightly higher rates of bleeding when compared to other DOACs in this situation<sup>7</sup>. The use of oral DOACs is also associated with higher patient satisfaction compared with subcutaneous LWHs. Currently, the use of DOACs for VTE prophylaxis after other types of surgery is not recommended. The routine use of DOACs for VTE prophylaxis instead of low molecular weight heparin (LMWH) in hospitalised medical patients is also not currently recommended. A recent metanalysis showed no benefit in symptomatic patients and an associated higher risk of major bleeding<sup>10</sup>.

All three DOACs are effective in treating confirmed venous thrombosis and embolic events<sup>7</sup>. Multiple phase III trials have demonstrated their efficacy in more than 27,000 patients – more than 11,000 with PE – in preventing recurrent VTE or VTE-related death<sup>11</sup>.

**Table 2. TGA approved indications and PBS listing for DOACs available in Australia<sup>6</sup>**

		DOACs		
		Dabigatran	Rivaroxaban	Apixaban
TGA approved indications and PBS listing	<b>Stroke prevention in non-valvular AF</b>	150 mg, twice daily or 110 mg, once daily in patients with any of the following: <ul style="list-style-type: none"> <li>CrCL 30–50 ml/min</li> <li>age over 75 years</li> <li>high risk of major bleeding</li> </ul>	20 mg, once daily or 15 mg, once daily if CrCl 30–40 ml/min	5 mg, twice daily or 2.5 mg twice daily for patients with two or more of the following: <ul style="list-style-type: none"> <li>age ≥80 years</li> <li>body weight ≤60 kg</li> <li>serum creatinine ≥133 µmol/L</li> </ul>
	<b>PBS listed</b>	Yes	Yes	Yes
	<b>Venous thromboembolism prophylaxis after hip and knee surgery</b>	<b>Hip:</b> 220 mg once daily for 28–35 days <b>Knee:</b> 150 mg twice daily for 10 days or <b>Knee &amp; Hip:</b> 150 mg, once daily in patients with CrCl 30–50 ml/min	<b>Hip:</b> 10 mg once daily for 35 days <b>Knee:</b> 10 mg once daily for 14 days	<b>Hip:</b> 2.5 mg twice daily for 32–38 days <b>Knee:</b> 2.5 mg twice daily for 10–14 days
	<b>PBS listed</b>	Yes	Yes	Yes
	<b>Treatment or prevention of recurrence of venous thrombosis and pulmonary embolism</b>	<b>Treatment &amp; Prevention:</b> 150 mg twice daily, following treatment with a parenteral anticoagulant for ≥5 days or <b>Treatment &amp; Prevention:</b> 110 mg, twice daily, in patients with any of the following: <ul style="list-style-type: none"> <li>CrCL 30–50 ml/min</li> <li>age over 75 years</li> <li>high risk of major bleeding</li> </ul>	<b>Treatment:</b> 15 mg, twice daily, for 21 days <b>Prevention:</b> 20 mg, once daily, after 21 days of DVT/PE treatment	<b>Treatment:</b> 10 mg, twice daily, for 7 days, then 5 mg, twice daily <b>Prevention:</b> 2.5 mg, twice daily, after ≥6 months of DVT/PE treatment
	<b>PBS listed</b>	No	Yes	Yes
	<b>Prevention of major cardiovascular events in CAD and/or PAD</b>	N/A	2.5 mg, twice daily, in combination with 100 mg aspirin, daily	N/A
	<b>PBS listed</b>	N/A	No	N/A



## OFF-LABEL USE

In addition to the above indications, there are increasing numbers of case reports and small studies of DOACs being used for “off-label” indications such as intra-cardiac thrombi (mural and left atrial appendage) and valvular heart disease<sup>12,13</sup>. A recent retrospective database review of 2230 patients with AF and mitral stenosis showed favourable outcomes for both thromboembolism prevention and adverse events<sup>13,14</sup>. Currently there are no randomised controlled trials in these patient groups.

There is no indication for DOACs following bioprosthetic (tissue) heart valves as, following an initial three-month period of warfarin (mitral and tricuspid only), low dose aspirin alone for thromboprophylaxis is adequate for thromboprophylaxis.

The use of DOACs in patients with mechanical heart valves is contraindicated<sup>12</sup>. A phase II trial (RE-ALIGN study) comparing dabigatran with warfarin in patients with aortic or mitral mechanical heart valves was terminated early due to an excess of thromboembolic and bleeding events among patients in the dabigatran group<sup>15</sup>. DOAC use post transcatheter aortic valve replacement (TAVR) has also been associated with an increase in all-cause mortality and bleeding risk when compared with anti-platelet therapy alone and is not currently recommended (GALILEO study)<sup>13,16</sup>.

## DOSE MONITORING OF DOACS

Unlike warfarin, DOACs do not need routine monitoring for dose adjustment due to their predictable pharmacokinetics. It is, however, important to measure the effect of these drugs in some clinical situations, particularly the perioperative period.

Standard laboratory tests are unreliable for monitoring the effects of DOACs. Prothrombin time (PT), activated partial thromboplastin time (aPTT) and thrombin time (TT) have all been used and are affected by DOACs but their sensitivity depends on which DOAC is involved, the dose administered and the reagents used by the individual laboratory<sup>4,5</sup>.

TT is highly sensitive to dabigatran. A normal TT excludes the presence of dabigatran. However, very low and clinically insignificant plasma levels will produce a very long or unmeasurable TT making it unsuitable for monitoring<sup>4,5</sup>. PT levels can be useful for monitoring rivaroxaban. A normal PT indicates that a clinically significant rivaroxaban effect is not likely. In contrast, apixaban has limited effect on PT so this test should not be used for monitoring the effects of this drug<sup>5</sup>. An anti-Xa-activity of < 0.1 IU/ml calibrated for low molecular weight heparins has been reported to exclude an increased risk of bleeding in patients taking factor Xa inhibitors (rivaroxaban and apixaban) but is not recommended for routine monitoring of this class of drug<sup>4</sup>.

Specific plasma drug assays are available for both rivaroxaban and apixaban. The laboratory should be notified which anti-Xa drug the patient is taking so that the correct chromatographic assay can be used. Dabigatran levels can be measured using the Hemoclot assay (see Table 3)<sup>4,17</sup>. Generally, a plasma level of 50ng/ml or more is considered therapeutic for these drugs.

Drug levels for DOACs are not routinely measured for patients maintained on DOACS due to their stable pharmacokinetics. This is considered one of their major advantages over warfarin. Despite this, there are situations where drug level monitoring may change clinical management, for example, during the perioperative period, if the patient has a major haemorrhage event, or if the patient has a significant change in their renal or hepatic function<sup>5</sup>. While plasma drug ranges for recommended doses have been measured for some DOACs (for example, apixaban 50-200ng/ml), there are no published target therapeutic ranges for any of the available DOACs on the market<sup>5,18</sup>. While higher plasma levels have been shown to correlate with an increased bleeding risk, there are no studies correlating specific plasma drug levels with clinical outcomes<sup>18</sup>.

Bedside viscoelastic tests (ROTEM and TEG) are affected by DOACs. They will prolong the clotting time for both the EXTEM and INTEM on ROTEM in a dose dependent manner. This is likely to be useful in patients with higher plasma drug levels but is not always reliable. Studies looking at the effect of DOACs on TEG parameters have shown variable outcomes<sup>19</sup>.

All DOACs are excreted to some degree in the urine, depending on the drug and the patient's renal function. A urine dipstick test (DOASENSE) can test for the presence or absence of inhibitors of Xa and for direct thrombin inhibitors<sup>20</sup>. This urine test offers several advantages over plasma drug levels. It is quick, taking only 10 minutes, and accurate, is less invasive than plasma sampling and overcomes difficulties in patients that are difficult to draw blood from<sup>21</sup>. Urine dipstick testing, however, is not quantitative and although it correlates well with the presence of the drug in plasma, as yet there are no trials validating its use in the context of clinical outcomes in the perioperative period<sup>22</sup>. It is likely to be of best use in the emergency setting when rapid detection of the presence of the drug in plasma will alter management.

## PERIOPERATIVE MANAGEMENT

### Elective surgery

Elective surgical patients should have their DOACs held. The duration of time each DOAC should be ceased for before surgery depends on the specific drug, whether the patient is taking a prophylactic or therapeutic dose, the type of surgery and the patient's renal function (see Table 3). A minimum of two to three half-lives of the drug are required, with a longer period of interruption required for dabigatran if renal impairment is present. Patients undergoing surgery with a high associated risk of bleeding will need their DOAC held for longer than for surgery with a lower bleeding risk (see Table 4).

A significant advantage of DOACs is that there is no role for preoperative bridging therapy in patients on DOACs for non-valvular AF because the half-life of the drugs and therefore the time off treatment is so short. However, if surgery is delayed and the DOAC has been held for more than four days, bridging with LMWH or heparin infusion is recommended<sup>5,23</sup>.

The PAUSE trial looked at a specific periprocedural cessation pathway for patients on prophylactic doses of DOACs for AF in 3007 patients (see Table 3)<sup>24</sup>. In general, holding apixaban or rivaroxaban for 24 hours and dabigatran for 48 hours prior to surgery is sufficient for low risk surgery in patients with normal renal function. Cessation for two to four days will be required for patients with renal impairment or for those undergoing high bleeding risk surgery (see Table 3)<sup>23,24</sup>. With this approach, major bleeding complications ranged from 0.9-1.8 per cent depending on the DOAC involved<sup>24</sup>. Some procedures may be able to be performed without ceasing DOACs (for example, cataract, gastroscopy)<sup>5</sup>. The recommended holding time for DOACs assumes the patient is on the appropriate dose for the patient's renal function<sup>5,7</sup>.

The PAUSE trial also looked at plasma drug levels at the time of surgery. The PAUSE strategy resulted in a plasma drug level below 50ng/ml in more than 90 per cent of patients<sup>24</sup>. It is reasonable to assume that drug levels below 50ng/ml are safe to proceed with caution with many types of surgery, however, levels below 30ng/ml are recommended for most high bleeding risk procedures<sup>4,25</sup>.

Patients on therapeutic doses of DOACs for management of VTE or PE are of more concern as they are at an increased risk of recurrence of thromboembolic events even on therapy (up to 3 per cent) and may need longer times off their higher-dose DOAC before surgery. These patients should have careful consideration made to their bridging plan preoperatively, and especially postoperatively when at increased risk due to immobility and alterations in their coagulation profile<sup>7</sup>. The use of inferior vena cava (IVC) filters or left atrial appendage (LAA) closure devices in this group may be of benefit if anticoagulation must be ceased and bridging is difficult.

Neuroaxial anaesthesia is particularly high risk with regard to the ramifications of bleeding related complications and an undetectable (<20ng/ml) plasma level is desired (see Table 3)<sup>4,26</sup>. The American Society of Regional Anaesthesia (ASRA) has published guidelines in 2018 to advise anaesthetists on safe practice regarding cessation of DOACs (see Table 3). In patients on higher treatment doses of DOACs for treatment of VTE, neuroaxial blocks should be avoided for at least 72 hours after the last dose of DOACs or even longer with dabigatran in renal impairment (72-120 hours). Measurement of plasma levels can be considered before the 72-hour window to help guide decision making. Patients on lower prophylactic doses of DOACs for the prevention of VTE can safely undergo neuroaxial block 24-36 hours after the last dose<sup>27</sup>. Patients on dabigatran with CrCl <30 ml/min should not undergo neuroaxial blockade<sup>23,27</sup>.

Although no safe plasma levels have been published for neuroaxial anaesthesia, it is reasonable to conclude that due to the potential catastrophic nature of bleeding complications, an abundance of caution should be taken and neuroaxial block only performed if residual drug levels are undetectable (<20ng/ml). Following neuroaxial block or manipulation of a neuroaxial catheter, DOACs should not be administered for six hours (see Table 3)<sup>27</sup>.

Patients undergoing peripheral nerve block may be able to undergo their procedure earlier than those undergoing neuroaxial block<sup>5</sup>.

**Table 3. Management of DOACs in the perioperative period. (Note: neuroaxial blockade can be undertaken earlier in patients on lower, prophylactic doses of DOACs)<sup>5,23-27</sup>**

		DOACs		
		Dabigatran	Rivaroxaban	Apixaban
	<b>Dabigatran</b>	<b>150 mg twice a day</b>	<b>20 mg once a day</b>	<b>5 mg twice a day</b>
		48–72 (CrCl >50 ml/min) 96 (CrCl 30–49 ml/min)	48–72	48–72
	<b>High bleeding risk (4-5 half-lives)</b>	24 (CrCl >50 ml/min)	24	24
	<b>Low bleeding risk (2-3 half-lives)</b>	48–72 (CrCl 30–49 ml/min)	1.85% (95% CI, 0%–2.65%)	1.35% (95% CI, 0%–2.00%)
	<b>Risk of major bleeding in 30 days</b>	0.9% (95% CI, 0%–1.73%)	A normal APTT and PT does not exclude the presence of Rivaroxaban	A normal APTT and PT does not exclude the presence of Apixaban
	<b>Standard laboratory blood tests before surgery</b>	TT < 20 secs – Excludes presence of dabigatran Prolonged TT and APTT indicates likely significant anticoagulant effect presence of dabigatran	safe to proceed	safe to proceed
	<b>Safe plasma levels for surgery</b>	<20 ng/ml – Excludes residual effect and safe to proceed 20–50 ng/ml – Minimal residual effect, proceed with caution if surgery cannot be delayed 8 hours	<30 ng/ml – safe to proceed 30–50 ng/ml – Minimal residual effect, proceed with caution if surgery cannot be delayed 8 hours	<30 ng/ml – safe to proceed 30–50 ng/ml – Minimal residual effect, proceed with caution if surgery cannot be delayed 8 hours
	<b>For surgery</b>	CrCl >80 ml/min: 72 hours CrCl 50–79 ml/min: 96 hours CrCl 30–49 ml/min: 120 hours CrCl <30 ml/min: avoid Plasma level <20 ng/ml	Minimum 3 days (72 hours) Plasma level <20ng/ml	Minimum 3 days (72 hours) Plasma level <20 ng/ml
	<b>and time (hrs) for regional anaesthesia</b>	34–36	22–26	26–30
	<b>and time (hrs) after inadvertent dosing to remove regional catheter</b>			
	<b>Reversal agents</b>	Idarucizumab (Praxbind)	Andexanet alfa (Andexxa) Not available in Australia	Andexanet alfa (Andexxa) Not available in Australia
	<b>Specific</b>	PCC (Prothrombinex); 25–50iu/kg	PCC (Prothrombinex); 25–50iu/kg	PCC (Prothrombinex); 25–50iu/kg
	<b>Non-specific</b>			

**Table 4. Surgical bleeding risk classification<sup>5</sup>**

Bleeding risk	Surgery
None to minimal	Non-complex dental Ophthalmology e.g. cataract, glaucoma Endoscopy without surgery Superficial surgery Wound revision
Low to moderate	Endoscopy with biopsy Multiple or complex dental extraction Prostate or bladder biopsy Pacemaker or ICD insertion Hernia repair
High	Open pelvic, abdominal, and cardiothoracic surgery Urology Intracranial neurosurgery Major orthopaedic and trauma surgery Major vascular surgery Posterior chamber eye surgery

#### Emergency surgery and bleeding patients

Patients who require emergency surgery or who present with bleeding when taking DOACs can provide challenges for the anaesthetist. Often DOAC history may be unknown or difficult to obtain in the emergency setting. In addition, acute kidney injury is common in this scenario so drug clearance can be significantly altered. In these situations, urine dipstick testing provides a simple and rapid method to ascertain the presence of any of the three DOACs in the blood. If the dipstick test is negative, it is unlikely there is significant DOAC in the plasma and any surgery required can proceed. If it is positive, it will help identify which DOAC is present and should prompt further investigation and management if bleeding is uncontrolled or if surgery cannot be delayed<sup>2</sup>.

For all patients who present for emergency surgery, the immediate cessation of DOACs should occur. The administration of activated charcoal has been advocated if DOAC administration was less than three hours prior to presentation<sup>3,4</sup>. Often a delay of 12–24 hours can reduce the plasma drug levels significantly, especially if on low doses for VTE prophylaxis, provided renal and hepatic function is normal. For patients requiring urgent surgery that can be safely delayed, it may be prudent to wait the appropriate length of time or for safe plasma levels to proceed (see Table 3)<sup>5</sup>.

For those that cannot wait for surgery, steps should be taken to reduce the risk of major bleeding. Plasma levels above 50ng/ml are generally considered high enough to warrant reversal<sup>5</sup>. Haemodialysis can be used to remove dabigatran from the plasma but this is ineffective for rivaroxaban or apixaban. Occasionally, there is insufficient time before emergency surgery to wait for laboratory plasma levels, in which case, clinical judgement should be used as to the necessity of reversal. Time since ingestion, renal function and type of surgery should all be taken into consideration when deciding whether reversal is necessary without plasma level results<sup>5</sup>.

Dabigatran can be reversed using idarucizumab (Praxbind), a monoclonal antibody that binds to dabigatran with very high affinity. It has an affinity for dabigatran that is more than 300 times that of the affinity of thrombin<sup>4,6</sup>. Idarucizumab is available for use in Australia for the emergency reversal of dabigatran but is not currently listed on the PBS. In the RE-VERSE-AD trial, following administration of 5g of idarucizumab, dabigatran levels were undetectable (<20ng/ml) within minutes and for 24 hours in most patients. This study included both patients with major bleeding (GI, intracranial) and patients who required urgent surgery<sup>7</sup>. A second dose is occasionally required after 24 hours if there is further postoperative bleeding<sup>3</sup>. Importantly, in this trial, thrombotic complications occurred in 6–7 per cent of patients within the first 90 days<sup>6,7</sup>.

Both rivaroxaban and apixaban can be reversed using andexanet alfa (Andexxa), however as of 2021 it remains unavailable in Australia. Andexanet alfa is a recombinant form of a modified human factor Xa that binds the drug in question but has no active site thus has no effect on coagulation<sup>4,8</sup>. It is usually given as a bolus followed by an infusion due to its short half-life (5–7 hours). After administration, thrombin generation levels will return to 96 per cent of normal<sup>8</sup>.

DOACS can be at least partially reversed prior to emergency surgery or during major bleeding using a prothrombin complex concentrate (PCC) such as Prothrombinex at a dose of 25-50iu/kg. PCC use for reversal of DOACs is off-label and the evidence for its use is limited, although several studies reported that major bleeding can be controlled in around two-thirds of patients<sup>3,5</sup>. In addition, the use of PCC in the perioperative period is not without risk of thrombotic complications. Bearing these risks in mind, it is often sufficient to proceed to surgery with caution and only treat if major bleeding occurs<sup>6</sup>. Fresh frozen plasma (FFP) should not be used to reverse oral anticoagulants as the concentration of clotting factors is too low to be effective<sup>5</sup>. Other supportive measures such as mechanical compression, blood transfusion, temperature management, antifibrinolytic use and blood pressure control should all be used.

### Postoperative resumption of DOACs

Anticoagulant related perioperative bleeding almost always occurs in the postoperative period when either resumption of therapeutic treatment or commencement of prophylactic anticoagulation occurs. When deciding at what time to resume DOAC therapy following surgery, clinicians should consider the risk and ramifications of postoperative bleeding and the indication for the DOAC.

In patients who have undergone surgery with immediate and complete haemostasis, it may be safe to resume DOAC therapy in as little as 6-8 hours. Otherwise, following surgery with a low risk of bleeding, it is usually safe to restart DOACs after 24 hours providing haemostasis has been achieved<sup>1,9,10</sup>. The rapid onset after ingestion of DOACs is an advantage in this situation as the duration of time without full anticoagulation is short and bridging anticoagulation is usually not required. This makes the management of postoperative anticoagulation for minor and low risk surgery far easier when compared with warfarin.

For patients who have had surgery with high risk of bleeding, DOAC resumption should not occur for a minimum of 48-72 hours. In some cases, this may need to be even longer if haemostasis in high-risk cases has been difficult to achieve<sup>1,9,10</sup>. In these situations, bridging with LMWH or heparin infusion should be considered, particularly for those at high risk of thromboembolism. Commencing with prophylactic doses of DOACs for a short time prior to recommencing full therapeutic doses has been advocated by some based on the results from orthopaedic trials but has not been formally investigated for other types of surgery<sup>1</sup>.

For patients who have regional catheters in place, the ASRA guidelines recommend against recommencing DOACs while the catheters are in situ and for at least six hours after their removal<sup>11</sup>. If a DOAC has inadvertently been given, the guidelines suggest waiting for 22-36 hours depending on which drug was given (see Table 3), or measuring a plasma level prior to removing the catheter<sup>11</sup>.

Finally, when considering the resumption of DOAC therapy, postoperatively, it is important to consider acute changes in renal function. It may be necessary to reduce the initial dose to less than the patient's usual preoperative dose until renal function improves.

## CONCLUSION

Over the past decade, DOACs have become the anticoagulants of choice for VTE prophylaxis in patients with AF, DVTs, PEs and after orthopaedic surgery and for the treatment of established DVTs and PEs. It is now common to see patients taking these drugs present for surgery and with the indications for this class of drug expanding, this will only increase. Having a good knowledge of the pharmacology and how to manage these drugs in both emergency and elective surgery and in patients experiencing bleeding events, will enable anaesthetists to manage these situations safely and effectively.

## REFERENCES

- Ganetsky M, Babu K, Salhanick S, Brown R, Bouyer E. Dabigatran: Review of pharmacology and management of bleeding complications of this novel oral anticoagulant. *J Med Toxicol.* 2011; 7:281-7.
- Stangier J, Clemens A. Pharmacology, pharmacokinetics, and pharmacodynamics of dabigatran etexilate, an oral direct thrombin inhibitor. *Clin Appl Thromb Hemost.* 2009; 15(1S):9S-16S.
- Yeh C, Fredenburgh J, Weitz J. Oral direct factor Xa inhibitors. *Circ Res.* 2012; 111(8):1069-78.
- Erdoes G, Martinez Lopez De Arroyabe B, Bolliger D, Ahmed A, Koster A, Agarwal S, et al. International consensus statement on the peri-operative management of direct oral anticoagulants in cardiac surgery. *Anaesthesia.* 2018; 73:1535-45.
- Untereiner O, Seince P, Chterev V, Leblanc I, Beroeta C, Bourel P, et al. Management of direct oral anticoagulants in the perioperative setting. *J Cardiothoracic Vasc Anesth.* 2015; 29:741-8.
- MedicineWise N. NOAC indications and PBS listing [Internet]. NPS Medicinewise; 2021 March 26. Available from: <https://www.nps.org.au/professionals/anticoagulants/noac-indications-and-pbs-listings>.
- Fabbro M, Dunn S, Rodriguez-Blanco Y, Jain P. A narrative review for perioperative physicians of the 2017 ACC expert consensus decision pathway on management of bleeding in patients on oral anticoagulants. *J Cardiothorac Vasc Anesth.* 2019; 33:290-301.

- Lopez-Lopez J, Sterne J, Thom H, Higgins J, Hingorani A, Okoli G, et al. Oral anticoagulants for prevention of stroke in atrial fibrillation: Systematic review, network meta-analysis, and cost effectiveness analysis. *BMJ.* 2017; 359:j5631.
- Anderson D, Morgano G, Bennett C, Dentali F, Francis D, Garcia D, et al. American society of hematology 2019 guidelines for management of venous thromboembolism: Prevention of venous thromboembolism in surgical hospitalized patients. *Blood Adv.* 2019; 3(23):3898-944.
- Neuman I, Izcovich A, Zhang Y, Rada G, Kahn S, Spencer F, et al. DOACs vs LMWHs in hospitalized medical patients: A systematic review and meta-analysis that informed 2018 ash guidelines. *Blood Adv.* 2020; 4(7):1512-7.
- Tromeur C, van der Pol L, Mairyhu A, Leroyer C, Couturaud F, Huisman M, et al. Novel anticoagulant treatment for pulmonary embolism with direct oral anticoagulants phase 3 trials and clinical practice. *Semin Intervent Radiol.* 2018; 35:83-91.
- Charlesworth M, Arya R. Direct oral anticoagulants: Peri-operative considerations and controversies. *Anaesthesia.* 2018; 73:1460-3.
- Abdenelnabi M, Almaghraby A, Saleh Y. Will direct oral anticoagulants have a chance in prosthetic valves? *Eur Cardiol.* 2020; 15:e06.
- Kim J, Kim S-H, Myong J-P, Kim Y, Kim T-S, Kim J-H, et al. Outcomes of direct oral anticoagulants in patients with mitral stenosis. *JACC.* 2019; 73(10):1123-31.
- Eikelboom J, SJ C, Brueckmann M, Granger C, Kappetein A, Mack M, et al. Dabigatran versus warfarin in patients with mechanical heart valves. *NEJM.* 2013; 369(13):1206-14.
- Dangas G, Tijssen J, Woehle J, Sondergaard L, Gilard M, Moellmann H, et al. A controlled trial of rivaroxaban after transcatheter aortic-valve replacement. *NEJM.* 2019; 382(2):120-9.
- Stangier J, Feuring M. Using the hemoclot direct thrombin inhibitor assay to determine plasma concentration of dabigatran. *Blood Coagul Fibrinolysis.* 2012; 23(2):138-43.
- Martin K, Moll S. Direct oral antiagulant drug level testing in clinical practice: A single institution experience. *Thromb Res.* 2016; 143:40-4.
- Cate H, Henskens Y, Lance M. Practical guidance on the use of laboratory testing in the management of bleeding in patients receiving direct oral anticoagulants. *Vasc Health Risk Manag.* 2017; 13.
- Harenberg J, Du S, Kramer S, Weiss C, Kramer R, Wehling M. Patients' serum and urine as easily accessible samples for the measurement of non-vitamin K antagonist oral anticoagulants. *Semin Thromb Hemost.* 2015; 41(228-36).
- Favaloro E, Lippi G. The pointy end of point-of-care testing for direct oral anticoagulants. *Thromb Haemost.* 2019; 120(1):11-3.
- Harenberg J, Beyer-Westendorf J, Crowther M, Elalamy I, Verhamme P, Bauersachs R, et al. Accuracy of a rapid diagnostic test for the presence of direct oral factor Xa or thrombin inhibitors in urine — a multicentre trial. *Thromb Haemost.* 2020; 120(1):132-40.
- McIlmoyle K, Tran H. Perioperative management of oral anticoagulation. *BJA Educ.* 2018; 18(9):259-64.
- Douketis J, Spyropoulos A, Duncan J, Carrier M, Le Gal G, Tafur A, et al. Perioperative management of patients with atrial fibrillation receiving a direct oral anticoagulant. *JAMA Intern Med.* 2019; 179(1):1469-78.
- Langer A, Connors J. Assessing and reversing the effect of direct oral anticoagulants on coagulation. *Anesthesiology.* 2020; 133:223-32.
- Ashken T, West S. Regional anaesthesia in patients at risk of bleeding. *BJA Educ.* 2021; 21(3):84-95.
- Horlocker T, Vandermeulen E, Kopp S, Gogarten W, Leffert L, Benzon T. Regional anesthesia in the patient receiving antithrombotic or thrombolytic therapy - American Society of Regional Anesthesia and Pain Medicine evidence-based guidelines (fourth edition). *Reg Anesth Pain Med.* 2018; 43:263-309.
- Pollack C, Reilly P, van Ryn J, Eikelboom J, Glund S, Bernstein R, et al. Idarucizumab for dabigatran reversal — full cohort analysis. *NEJM.* 2017; 377:431-41.
- Reed M, Tadi P, Nicholas D. Andexanet alfa. Treasure Island (FL): StatPearls Publishing; 2021 Jan.
- Sunkara T, Ofori E, Zarubin V, Caughey M, Gaduputi V, Reddy M. Perioperative management of direct oral anticoagulants (DOACS): A systemic review. *Health Serv Insights.* 2016; 9:25-36.



# Pain

## **An update on intrathecal baclofen**

Corinne Teh, Sharon Keripin

---

## **Enhancing powerful medication – applications of the placebo response for pain management**

Andrew Watson, Thomas Bruessel

---

## **Aue, Ta fia Ola! Pain and the faaSamoa**

Leinani Aiono-Le Tagaloa, Brenda Cassidy

---

## An update on intrathecal baclofen

### Dr Corinne Teh, MBBS BMusA

Resident Medical Officer, Pain Management Unit, The Queen Elizabeth Hospital, South Australia

Dr Teh has an interest in anaesthesia training, pain and perioperative medicine and is currently in a clinical research role of a trial of advanced recovery room care for enhanced recovery after surgery at the Royal Adelaide Hospital, South Australia.

### Dr Sharon Keripin, MBBS FAFRM FFPMANZCA

Rehabilitation and Specialist Pain Physician, Pain Management Unit, The Queen Elizabeth Hospital, South Australia

Dr Keripin is currently working as a pain consultant at the Queen Elizabeth Hospital and Royal Adelaide Hospital and in private practice in Adelaide at The International Spine Centre. She is clinical lead for intrathecal baclofen management in South Australia.

## INTRODUCTION

Intrathecal baclofen (ITB) is used in the management of severe spasticity and dystonia, commonly seen in patients with cerebral palsy, multiple sclerosis, traumatic spinal cord injuries and acquired brain injury, particularly when more conservative therapies such as enteral baclofen, botulinum toxin (Botox) injections to skeletal muscle and physical therapies have failed<sup>1,2</sup>. The spasticity can be painful or nonpainful, and can interfere with sleep and functions such as sitting in wheel chair comfortably or showering. The disabling sedation associated with enteral baclofen can be markedly reduced by ITB. In this review we present a recent case of a life-threatening complication of ITB, discuss presentations of complications and their management and we review the role of ITB in current pain management.

## RECENT CLINICAL SCENARIO

A young adult patient with cerebral palsy-associated severe spasticity and dystonia managed long-term with intrathecal baclofen via an implanted Medtronic pump on a background of cerebral palsy presented to the Pain Management Unit for dose adjustment from approximately 1200mcg per 24 hours to 1300mcg per 24 hours on simple continuous mode. He had symptoms of a urinary tract infection (incontinence and frequency) and increased agitation and muscle rigidity over the previous 24 hours. Vital signs revealed a sinus tachycardia of 200 beats per minute, hypotension of 90/70mmHg and high-grade fever of 39.1. The patient was admitted to hospital, investigated for fever of unknown origin and treated for presumed sepsis with a likely urinary origin. He deteriorated and required admission to the intensive care unit for supportive care of rhabdomyolysis, acute renal failure and coagulopathy. He subsequently developed seizures and was sedated and intubated. A fluoroscopically guided aspiration of the intrathecal pump withdrew approximately 0.1-0.2mL of blood possibly indicating a complication related to the catheter interrupting the administration of baclofen to the intrathecal space. The patient was clinically in severe baclofen withdrawal although exclusion of meningitis could not be definitively proven. He was transferred to a quaternary centre intensive care unit for neurosurgical input and placed on nasogastric baclofen replacement of 40mg qid with stabilisation. The intrathecal catheter and pump were removed on day six post-admission without obvious fault in either device.

The diagnosis of baclofen withdrawal was masked by the clinical picture of sepsis thus treatment of withdrawal was delayed. The baclofen withdrawal mechanism remains unexplained though intermittent catheter kinking was the presumed problem because of looping subcutaneously. Due to previous complex spinal surgeries and scarring, future pump placement may be complicated. Thus, a pump replacement is still for further discussion, while the patient's dystonia is managed with oral anti-spasmodic medications (baclofen 30mg qid, diazepam 2mg tds and levetiracetam) and Botulinum toxin injections.

## PHARMACOLOGY OF BACLOFEN

Baclofen is a GABA agonist acting on the receptors in the spinal cord and reduces spasticity through presynaptic inhibition<sup>3</sup>. Intrathecal baclofen avoids systemic side effects associated with oral baclofen such as sedation, confusion, and lethargy<sup>4</sup>. The intrathecal dose required is less than 1 per cent of that delivered via oral route due to direct delivery to the central nervous system (CNS)<sup>4</sup>. Figure 1 is an illustration of typical placement of the pump under the skin of the abdomen with the catheter tunnelled under the skin and inserted into the CSF space.

ITB therapy can significantly improve quality of life for patients with painful and non-painful spasticity. However, as with any implanted device, there are risks of complications which should be carefully weighed against

the benefits of the therapy<sup>1,2</sup>. It is important to be aware of the potential complications of intrathecal therapy in this cohort of patients as there is a well reported percentage of adverse events in the range of 18-25 per cent<sup>5-7</sup>. A failure to recognise complications of intrathecal baclofen therapy often occur due to lack of awareness. Therefore, the patient, their family/carers and other people involved in their care (for example, school, paediatrician, GP and emergency department), should be aware of the potential complications, as some of these complications may warrant an emergency management. Figure 1 shows the lumbar placement of an intrathecal catheter and subcutaneous tunnelling to the pump placed in subcutaneous pocket on anterior abdominal wall shown in Figure 2.

**Figure 1. Diagram of intrathecal pump therapy, posterior view**



**Figure 2. Diagram of intrathecal pump therapy, anterior view**

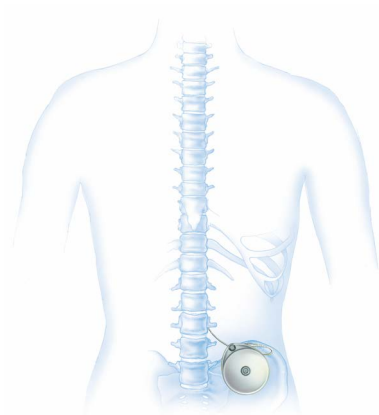

## COMPLICATIONS OF INTRATHECAL BACLOFEN

Complications relating to catheter factors appear more commonly than complications related to the implanted device (pump). Many catheter-related complications have been reported including: fracture, disconnection, kink, migration, laceration, leak, granuloma formation at tip and iatrogenic injury to catheter by procedures. Drug delivery pump complications have been reported due to programming failure or pump failure – electronic/battery failure and MRI magnets may unexpectedly stop the pump. Human factors have also been reported – refill failure (subcutaneous injection), prescribing error or pharmacy error and (delay) timing of refill and programming error.

Although infection of local and deep tissue, meningitis and abscess formation have been reported, this form of complication remains rare. Other sources of infection such as urinary tract infection and pneumonia are relatively common in this population.

## INTRATHECAL BACLOFEN OVERDOSE AND WITHDRAWAL

The clinical presentation of intrathecal baclofen withdrawal or overdose can overlap with many other diagnoses and often can present initially as a change in mental state in an already highly disabled patient. As either withdrawal or overdose can be life threatening, in addition to a high index of suspicion, careful evaluation clinically and urgent investigations are warranted. The variation in clinical presentation of ITB overdose/withdrawal can result in delayed diagnosis and subsequent delay in life saving treatment<sup>8</sup>. Table 1 outlines the presentation of intrathecal baclofen overdose and withdrawal; and its differential diagnosis<sup>8,9</sup>.

**Table 1. Differential diagnoses of intrathecal baclofen withdrawal or overdose<sup>8-12</sup>**

	ITB overdose	ITB withdrawal	Sepsis	Neuroleptic malignant syndrome	Serotonin syndrome	Malignant hyperthermia
<b>Mechanism</b>	Abrupt increase in CNS GABA- $\beta$ transmission	Abrupt decrease in CNS GABA- $\beta$ transmission	Systemic inflammatory response syndrome and end organ dysfunction	Dysautonomia Central dopamine blockade	Overload of serotonin transmission	Genetically susceptible individuals
<b>Causes</b>	Incorrect programming  Pump failure	Incorrect programming  Catheter problems Pump failure Human factors	Infection	Dopamine-receptor blocking agents (e.g. Antipsychotics, metoclopramide)  Withdrawal of dopamine agonists	Excessive central serotonin release and/or blocking serotonin reuptake  (i.e. SSRIs, or MDMA)	Volatile anaesthetics  Succinylcholine
<b>Time frame &amp; severity</b>	Within minutes	1-2 days  Life-threatening	Variable	Variable	Acute	Acute
<b>Haemodynamics</b>	Autonomic instability	Tachycardia Hypotension/ labile BP  Autonomic dysreflexia	Tachycardia  Hypotension	Tachycardia  Hypertension	Tachycardia  Autonomic instability	Tachycardia, arrhythmias
<b>Temperature</b>	$\uparrow\downarrow$	$\uparrow$	$\uparrow$	$\uparrow$	$\uparrow$	$\uparrow$
<b>Mental status</b>	Decreased conscious state  Delirium	Agitation  Delirium  Stupor/Coma	Delirium	Mental status change	Mental status change	N/A
<b>Muscle activity &amp; neurological</b>	Flaccidity  Hyporeflexia	Rebound spasticity and rigidity greater than patient's baseline	N/A	Increased muscle rigidity	Tremor  Hyperreflexia  Clonus	Increased muscle rigidity  Masseter muscle rigidity

<b>Other clinical features</b>	Respiratory failure	Pruritis	Multi-organ failure	Sweating	Ocular clonus	Hyperkalaemia
	Seizures	Seizures		Rhabdomyolysis		Hypercarbia
		Rhabdomyolysis			Dilated pupils	DIC
		Disseminated intravascular coagulation (DIC)			Bilateral	Cardiac arrest
		Multi-organ failure			Babinski signs	

## MANAGEMENT

Early referral to specialist centre for neurosurgical input and the patient's primary managing team (that is, paediatrician, rehabilitation physician or pain management physician) is essential<sup>8,13</sup>. Baclofen withdrawal is a medical emergency with life-threatening sequelae of severe hyperthermia, rhabdomyolysis and seizures as experienced by the patient in the case presented. If infection or meningitis is suspected, infectious disease specialist input is also recommended. Supportive treatment includes close monitoring of airway, respiration and circulation and rapid escalation to intensive care for multiorgan failure support when required<sup>10</sup>. If pump or catheter failure is suspected, pump interrogation and further imaging, that is, X-ray, fluoroscopy-guided contrast study, should be arranged as soon as possible. This may require anaesthesia or sedation in a child or confused or unco-operative patient. Many of these patients are taking regular medication, and essential medications such as anticonvulsants should be continued orally if safe, or via nasogastric, PEG or intravenous delivery.

### Overdose

Clinical management of ITB overdose is supportive observation and treatments to maintain airway and breathing during over sedation while temporarily interrupting or reducing the delivery rate of ITB (via pump programming). Prevention, observation for and management of seizures during this time is advised. An aspiration of 30mL of CSF either via the pump access port or lumbar puncture and re-injection of the same volume of normal saline, should be considered in severe cases<sup>8</sup>.

### Withdrawal

Urgent enteral baclofen replacement is paramount in managing ITB withdrawal while awaiting the definitive treatment of restoration of the ITB delivery. The approximate enteral equivalent dose being of the order of 100 times the intrathecal dose. This can be initiated during investigations if withdrawal is suspected. Continuous intravenous benzodiazepines should be considered in addition to other seizure prevention and management measures such as anticonvulsants, antipyretics and imaging. Intravenous fluids and appropriate serial blood investigations for rhabdomyolysis and organ failure are indicated. Intensive care unit input and/or transfer for monitoring and organ support is indicated if ITB withdrawal is suspected.

### Infection

Clinicians have the option of CSF aspiration for microscopy, culture, and sensitivity via pump access port or alternate method such as lumbar puncture at a level distant from the intrathecal catheter so as not to damage it. Screening for other septic sources, such as urine microscopy and culture and chest X-ray, is also recommended. Broad-spectrum antibiotic coverage for meningitis is indicated while deciding if the intrathecal device should be removed. Removal of the device will result in acute ITB withdrawal, and the management described above would be indicated. In our local experience, the involvement of infectious disease physicians is helpful to guide antibiotic choice and decision-making in removing the entire delivery system. Removal of the pump is not always urgent.

## CONCLUSION

ITB therapy is a useful management option for refractory spasticity or dystonia but is associated with complications which can be fatal if severe and not addressed immediately. Patients with ITB also are susceptible to other severe pathologies. Early recognition and management prevent patients developing serious complications.

## REFERENCES

- Francisco GE, Saulino MF, Yablon SA, Turner MINGI. Intrathecal baclofen therapy: An update. *PM&R*. 2009; 1(9):852-8.
- Staats PS. Complications of intrathecal therapy. *Pain medicine (Malden, Mass)*. 2008; 9(S1):S102-S7.
- Taira T. Intrathecal administration of gaba agonists in the vegetative state. *Progress in Brain Research*. 2009; 117: 317-28.
- Stewart K, Hutana G, Kentish M. Intrathecal baclofen therapy in paediatrics: A study protocol for an Australian multicentre, 10-year prospective audit. *BMJ open*. 2017; 7(6):e015863-e.
- Borrini L, Bensmail D, Thiebaut J-B, Hugeron C, Rech C, Jourdan C. Occurrence of adverse events in long-term intrathecal baclofen infusion: A 1-year follow-up study of 158 adults. *Archives of physical medicine and rehabilitation*. 2014; 95(6):1032-8.
- Pucks-Faes E, Hitzenberger G, Matzak H, Fava E, Verrienti G, Laimer I, et al. Eleven years' experience with intrathecal baclofen – complications, risk factors. *Brain and Behavior*. 2018; 8(5).
- Motta F, Antonello CE. Analysis of complications in 430 consecutive pediatric patients treated with intrathecal baclofen therapy: 14-year experience. *Journal Neurosurgery Pediatrics*. 2014; 13(3):301-6.
- Delhaas EM, Huygen FJPM. Complications associated with intrathecal drug delivery systems. *BJA education*. 2020; 20(2):51-7.
- Coffey RJ, Edgar TS, Francisco GE, Graziani V, Meythaler JM, Ridgely PM, et al. Abrupt withdrawal from intrathecal baclofen: Recognition and management of a potentially life-threatening syndrome. *Archives of physical medicine and rehabilitation*. 2002; 83(6):735-41.
- Saulino M, Anderson DJ, Doble J, Farid R, Gul F, Konrad P, et al. Best practices for intrathecal baclofen therapy: Troubleshooting: Best practices for ITB troubleshooting. *Neuromodulation (Malden, Mass)*. 2016; 19(6):632-41.
- Jones SB. Malignant hyperthermia: Diagnosis and management of acute crisis [Internet]. UpToDate; 2019. Available from: <https://www.uptodate.com/contents/malignant-hyperthermia-diagnosis-and-management-of-acute-crisis>.
- Boyner EW. Serotonin syndrome (serotonin toxicity) [Internet]. UpToDate; 2021. Available from: [https://www.uptodate.com/contents/serotonin-syndrome-serotonin-toxicity?search=%27serotonin%20syndrome&source=search\\_result&selectedTitle=1~125&usage\\_type=default&display\\_rank=1](https://www.uptodate.com/contents/serotonin-syndrome-serotonin-toxicity?search=%27serotonin%20syndrome&source=search_result&selectedTitle=1~125&usage_type=default&display_rank=1).
- The Royal Children's Hospital Foundation. Intrathecal baclofen [Internet]. The Royal Children's Hospital Developmental Medicine, Neurosurgery, Paediatric Rehabilitation, Orthopaedics and Physiotherapy Departments; 2018. Available from: [https://www.rch.org.au/kidsinfo/fact\\_sheets/Intrathecal\\_baclofen/](https://www.rch.org.au/kidsinfo/fact_sheets/Intrathecal_baclofen/).

## Enhancing powerful medication – applications of the placebo response for pain management

**Andrew Watson BHB, MBChB, DRACOG, FRACGP, MTMMPH, FANZCA, Dip Clin Hyp**  
**Senior Staff Specialist in Anaesthesia and Pain, Calvary Bruce Public Hospital and The Canberra Hospital**

Dr Andrew Watson is a senior consultant with special interests in teaching and communication. He is a lecturer at the Australian National University Medical School. His main focus is on developing a range of practical, evidence-based communication skills and strategies to maximise our performance and the effects of the powerful therapies we prescribe, for both novice and highly skilled practitioners.

**Thomas Bruessel, Dr med, FANZCA**

**Department of Anaesthesia, Perioperative Medicine and Pain Management, Canberra Health Service, ACT**

Professor Thomas Bruessel is the Director of the Department of Anaesthesia, Perioperative Medicine and Pain Management at Canberra Health Services and Chair of Anaesthesia at the Australian National University. He has strong interests in regional anaesthesia, neuroanaesthesia and neuro medicine.

### INTRODUCTION

Our communication and the expectations we create make a powerful contribution to the response patients get to our strongest analgesics. This article will explore the rich and rapidly expanding placebo literature to focus on the underlying neurobiology of these responses and practical strategies to maximise the effects of our treatment.

A placebo is often described as an inert substance devoid of clinical effect, with its use outside of clinical trials banned by the Helsinki declaration<sup>1</sup> and associated with trickery and deception. However, the effect of placebo and patient-medical team interactions are far from inert. As we will explore further, many trials and expert opinion suggest these account for 30 per cent of the analgesia experienced from our most powerful medications<sup>2-8</sup>. Understanding and optimising this is a huge focus in pain management, illustrated by the fact that the International Association for the Study of Pain (IASP) has a special interest group devoted to placebo, and it has been identified as a significant gap in contemporary medical education. In clinical trials, the response to inert substances can be due to: the placebo effect, spontaneous resolution of symptoms/regression to the mean, and study flaws such as biases and false positives. This review explores the changes attributed solely to the placebo effect.

The placebo effect is a psychobiological phenomenon resulting from different mechanisms and pathways activated by patient expectations which can be shaped by our communication and learning or conditioning, including classical Pavlovian conditioning. Excellent studies investigating the role of these in enhancing therapy, or in the case of nocebo – often described as placebo's evil twin – reducing the efficacy of our treatments, will be reviewed in this article. The neural networks activated or inhibited are often shared with those responding to reward, fear or anxiety and will also be reviewed.

### THE NEUROBIOLOGY OF PLACEBO RESPONSES TO PAIN

Before discussing the mechanisms of the placebo effect, it is useful to briefly review our basic pain pathways and one of the key differences between pain and most of our other senses – the extensive modulation of the incoming signal before it arrives in the brain for processing.

Nociception is triggered from the activation of nociceptors by noxious stimuli, classically mechanical, chemical or thermal. These signals pass along a-delta or c fibres to the spinal cord, where they ascend or descend 1-2 levels before synapsing in the ipsilateral dorsal horn. Extensive modulation occurs in the dorsal horn such that signals are amplified, damped, or in some cases do not ascend to the brain at all. Powerful descending inhibitory neurons synapse here, as do some less well-known descending excitatory pathways. Interneurons activated by a range of inputs, not just nociception, also synapse here and as Mosely and Butler<sup>9</sup> note, the nociceptive synapses in the dorsal horn are “hugged by glial cells”. These glial cells occur in similar numbers to neurons and are actively involved in modulating synaptic activity, responding to a range of stimuli – including neurohormonal and inflammatory mediators<sup>10</sup>.

The second-order neuron decussates and ascends from the dorsal horn to synapse with third-order neurons, largely at the thalamus, projecting widely in the brain not just to the somatosensory cortex but also with strong connections to areas of the brain involved with processing reward, fear and anxiety.



Pain is an output, the end result of this processed nociceptive input, and its definition as “an unpleasant sensory and emotional experience” is a core part of both old and new IASP definitions of pain<sup>11</sup>. It functions as an alarm and has a complex crucial role in protecting us from danger, alerting us to injury, interrupting thoughts and allowing us to withdraw from the stimulus. It enables us to interact with higher pathways to lay down a strong memory to avoid that threat in the future and allows us to modify the strength of the incoming nociceptive signal depending on other sensory and emotional cues – such as being able to dampen this input while escaping from danger.

## MECHANISMS OF THE PLACEBO EFFECT

Studies utilising a range of different technologies have explored the activation of the brain in response to painful stimulus and how this is altered when a placebo is administered, as well as looking at nocebo. Other studies have looked at a range of biological mediators involved in these responses.

### Neuroimaging and EEG studies

EEG<sup>12</sup> and laser evoked potential<sup>13</sup> studies have demonstrated reduced amplitudes of event-related potentials to experimental pain stimuli with the administration of placebo analgesia. The majority of neuroimaging studies exploring placebo analgesia, fMRI and PET scans also found reduced activity in classic pain processing areas of the brain, including the thalamus, insula, somatosensory cortex and mid-cingulate regions, after placebo administration in response to painful experimental stimuli.

PET scanning after placebo analgesia shows the activation of the cingulo-frontal brain and subcortical midbrain regions (such as the periaqueductal gray (PAG) and amygdala, along with further connectivity analysis supporting the theory that activation of a descending inhibitory pain pathway is one important mechanism of placebo analgesia<sup>14-16</sup>. Activation of the prefrontal cortex in these studies, correlated with a positive placebo analgesic response in people with degenerated or disconnected frontal lobes such as in Alzheimer's disease, showed a loss of verbally-induced placebo analgesia<sup>17</sup>. fMRI studies indicate dorsal horn activity in response to nociceptive stimulation is substantially reduced under placebo and rises under expectations of increased pain (nocebo)<sup>18,19</sup>

Thus, neural processing in response to expectations has reduced the nociceptive input reaching the brain in response to a noxious stimulus. The brain's response to the input that does reach it is also reduced, as measured by EEG, fMRI and PET scanning.

## NEUROTRANSMITTERS

### Endogenous opioids

Endorphins were the first and best-studied compounds involved in generating placebo analgesia. Levine et al<sup>20</sup>, in a small study, demonstrated that naloxone could block the placebo response generated by positive verbal expectations. Subsequent studies have further substantiated these findings and identified other neurotransmitters involved in the placebo response (21)(2)(14).

PET studies with opioid receptor-specific radiotracer ligands have shown reduced  $\mu$  opioid receptor availability with the administration of placebo in expectation of a painful stimulus and that these changes were blocked by administering naloxone<sup>21,22</sup>. Lipman<sup>23</sup>, showed an increase in endorphins in the CSF for chronic pain patients who were placebo responders. Cholecystokinin (CCK) antagonises the antinociceptive effect of opioids, administration of CCK inhibits our response to opioids. The CCK antagonist proglumide enhances our response to opioids. Benedetti and others have shown the proglumide also enhances the placebo response to verbal expectations<sup>24</sup>.

Placebo-activated endogenous opioids have also been shown to produce respiratory depression. Benedetti<sup>25</sup> induced mild respiratory depression by administering buprenorphine in the post-operative phase. When administering a placebo after conditioning with buprenorphine, the same mild respiratory depression was seen, which was reversed by naloxone. Pollo<sup>26</sup> found they were able to generate a placebo response with a reduction in heart rate and B adrenergic activation from conditioning which was blocked by naloxone.

### Endocannabinoids

In 2011, Benedetti and others<sup>27</sup> used ketorolac cream to condition a response to a noxious stimulus before substituting it for a placebo cream. The placebo response they generated was inhibited by the cannabinoid 1 receptor antagonist rimonabant but not naloxone, indicating that endocannabinoids are also involved in the generation of a placebo response. In the same study, an additional placebo response was generated by strong verbal cues of improved analgesia in the subjects who had been conditioned with ketorolac and this additional analgesic effect was blocked by naloxone, but the analgesic response was not blocked at all in the subjects who had ketorolac conditioning alone.

### Dopamine

fMRI investigations of changes in the binding of the C-labelled dopamine receptor antagonist raclopride demonstrated increased dopaminergic neurotransmission in the nucleus accumbens, putamen, and caudate nucleus that correlated with the individual's placebo response to analgesia<sup>28</sup>. Whether this reflects a primary effect on pain processing or the secondary effect of reward centre activation by avoiding pain was not determined.

### Nocebo

Conditioning/learned responses, past experiences and expectations of increased pain are associated with hyperalgesia and a poorer response to analgesia than when there are no expectations<sup>29</sup>. Nocebo language and expectations are often used in clinical practice and will be explored further soon. While the mechanisms are similar to those involved in generating the placebo response, there are some key differences.

With classical Pavlovian conditioning, a response is paired to a reward; when this conditioning involves intermittent positive reinforcement – such as playing a slot machine – the behaviour or response takes much longer to extinguish when the reward is withheld than in a conditioning system where each response is given a reward – such as a vending machine. This is what we observe in the placebo effect. The response takes a long time to extinguish with the novel effect, regardless of which conditioning regimen was used, and is established faster.

### Other

The placebo response has been studied in other settings, such as Parkinson's disease<sup>30,31</sup> and depression<sup>32</sup>, and has produced very strong findings. Studies of immune function – such as one where a placebo response was learned via conditioning by pairing the active drug Cyclosporin A<sup>33</sup> with a flavoured drink – generate a significant placebo response to conditioning, though of a lesser magnitude than that seen to pain. In general, studies of hormonal secretion and immunomodulation showed responses generated by conditioning, but not cues of verbal expectation<sup>29,34,35</sup>.

## KEY CLINICAL CONSIDERATIONS

While many studies have shown a placebo response accounting for around 30 per cent of the analgesia we experience from medication, experts note the significant heterogeneity in the results of placebo studies – a range of 10-60 per cent for pain<sup>2-8</sup> and that it is impossible to come up with a single figure. It is not surprising with this heterogeneity, that a range of factors have been shown to have a big influence on the magnitude of the expectancy response to pharmacology. This section will explore these factors in more detail.

### The hidden open paradigm

This paradigm provides an excellent illustration of the big role of expectation in enhancing the powerful pharmacotherapy we use in clinical practice. It refers to the different responses we have to analgesia if we are told we are receiving medication in comparison to when it is given without informing the subject, such as when it is added to an intravenous infusion hidden from the patient.

In one study<sup>36</sup>, participants had intravenous cannulas inserted and then were administered a painful thermal stimulus with an intensity rated 6.5/10 on average. Participants were then put under fMRI and told to expect a range of sensory effects from the MRI. Under fMRI, the painful thermal stimulus was repeated. In one cohort, remifentanyl was administered without informing patients prior to the stimulus being repeated, while the other cohort was told the powerful painkiller remifentanyl was being administered prior to the stimulus being repeated. The results were striking: in the group who received remifentanyl without being informed, pain scores in response to the identical second thermal stimulus fell just one point to 5.5, which is not clinically significant, while the group receiving remifentanyl who were informed they were receiving a powerful pain killer reported average pain scores of just 3.5.

These results were consistent with other studies investigating ketorolac, tramadol, morphine and buprenorphine<sup>37-39</sup>. Similar studies into the hidden open paradigm with pain in a clinical setting, such as with rizatriptan in migraine, showed the treatment effect was doubled if the active drug was coupled with an explanation about receiving active medication. This demonstrates the translation of the hidden open paradigm from the lab into clinical practice.

Studies have explored how this may affect clinicians. For instance, when staff were told that they were administering fentanyl for post-operative dental pain, and were given syringes labelled as such (but it was saline only), the patients received increased analgesia compared to those whose clinicians were told they were administering saline<sup>40</sup>.

**Practice tip 1:**

Informing a patient we are administering powerful medication to help their pain can greatly enhance its effect, doubling it in several clinical and experimental trials.

**The nocebo effect**

Verbal and non-verbal cues and phrases such as: “this is the worst part,” or “a little bee sting” prior to cannulation or other procedures increase the pain and discomfort of the procedure<sup>41,42</sup>. Lang et al<sup>41</sup> and others demonstrated phrases warning of undesirable or painful experiences prior to a noxious stimulus resulted in greater pain while sympathetic language also increased anxiety afterwards.

Phrases such as “try not to *move*...”, this “won’t *hurt*”, “it might *sting* a little”, “don’t *worry*” inadvertently focus our attention on and guide us to the effect we are trying to avoid, providing the opposite effect we are striving for<sup>43</sup>. In the same way, if I ask someone to try *not* to think of an elephant ice skating, they are likely to immediately form this image in their mind.

Pain is a nocebo word increasing hyperalgesia. For example, Cyna and others gave a group of women PCA’s to use after a caesarean section and instructed them to use these for bothersome symptoms<sup>44</sup>. One cohort was asked to rate their pain score out of 10, the other to rate comfort out of 10. The group asked to rate comfort used less PCA medication than those asked for their pain scores.

Nocebo cues (such as handing a bag for potential emesis) and phrases such as a “sting” prior to cannulation or “burning” prior to administration of propofol will also increase pain<sup>43,45</sup>. Staff will often explain this as “being honest”, and yet many patients do not perceive propofol as painful and may associate a sting with tissue injury and even anaphylaxis. We cannot truly know how another person will feel, and hence framing a therapeutic experience in a negative emotional context is likely to reduce the efficacy of our treatment and cannot be described as honest.

**Practice tip 2:**

Look for the negative suggestions used commonly in medical practice and form alternatives.

The book, *Handbook of Communication in Anaesthesia and Critical Care* by Cyna A, Andrew M, Tan S and Smith A has many practical examples.

**The roadmap metaphor**

If one was to jump into a taxi and ask the driver to drive without stating a destination, it is hard to predict where one would end up. In stressful and unfamiliar environments where there are gaps in information about what to expect (which is how many people find operating theatres), the mind will create its own map, which can lead to an unwanted destination.

An example of this is a recent study in pain which found that acute anxiety prior to the procedure (state anxiety) was a strong predictor of post-operative pain, much more so than having an anxiety disorder (trait anxiety)<sup>47</sup>. This is exactly the window where we, as anaesthetists, with brief verbal reframing can have a great therapeutic impact. Another illustration was a study showing two thirds of an unselected sample of 34 students reported mild headaches when told that a non-existent electrical current was passing through their heads<sup>48</sup>.

Multiple studies on chronic pain have supported Mosely and Butlers’ approach<sup>9,49</sup>, showing that pain education about neuroscience and the plasticity of the nervous system reduces pain, disability and catastrophisation. This education utilises metaphors and includes a focus on the possibility of change – I would describe it as providing the patient with a map.

Compare these phrases prior to intravenous cannulation:

“try not to move, little bee sting, don’t worry, this is the worst part...”

With the factual phrase:

“May I put in this cannula so that we can give the powerful medicines to keep you safe and comfortable for this operation” or “to give you the powerful antibiotics to cure this infection so that you can get home to your children.”

A patient may say, “will it hurt, doc?”

The doctor may reply, “you will feel what you feel, but many people are surprised to find it is much easier and more comfortable than they had expected”<sup>43</sup>.

**Practice tip 3:**

Simply telling people we are administering “powerful analgesia” or explaining the purpose of the procedure without emotional context, especially if using positive suggestion, is honest and will lead many people to a more pleasant experience.

**Trust and rapport**

Patients report more beneficial health behaviours, fewer symptoms, higher quality of life and more satisfaction with care, the higher their trust in the health professional<sup>50</sup>. Perceived warmth and competence are two key factors identified in multiple studies contributing to this increased trust in clinicians. Competence has been described as “the doctor gets it” (expert in the condition being treated) and warmth as “the doctor gets me”<sup>51</sup>.

Kapchuk<sup>52</sup> demonstrated that increased rapport resulted in a more powerful response to sham procedures. The strategies to increase rapport included: active listening, attentive behaviours, touch and social cues - such as being told Dr X is great.

In another study, enhanced care (increased warmth) using similar strategies and avoiding being interrupted by mobile phone calls increased the magnitude of analgesia in the group who were placebo responders; in the cohort who did not respond to placebo, they made no difference to analgesia<sup>53</sup>.

Context and cultural factors will contribute to how the patient interprets the doctor’s verbal and non-verbal cues. An example may be calling someone by their first name, which will often be a positive step in establishing rapport (the doctor being perceived as warm), but for some patients can be interpreted as less professional and thus associated with less competence. Strategies to increase both warmth and competence, such as asking someone what they would like to be called, magnify trust the most.

Perhaps the most important factor in establishing this rapport is active listening<sup>43,46</sup>. Listening for the content or facts, listening for the meaning this has for the patient and reflecting back to ensure that we have understood correctly and that the patient knows we have understood them.

**Practice tip 4:**

Perceived warmth and competence enhance the effects of placebo analgesia and reduce pain<sup>1</sup>.

**Optimism**

Seligman’s prize-winning work showed the benefits of optimism in health care, including that optimists survived longer post-myocardial infarction than pessimists and that the difference was as great as that between smokers and non-smokers<sup>54,55</sup>. Patients of optimistic doctors survived longer than those of pessimistic doctors, though pessimists were more often correct.

An optimist gives themselves credit for good news, does not take the blame, assumes good things last, and that positive developments spill into other areas of life. A pessimist assumes blame, that poor outcomes are due to their actions, assumes things won’t change and that a global impact of negative events will impact everything they do<sup>55</sup>.

**Practice tip 5:**

Engendering optimism in our patients by reframing their perceptions, focusing on things they do well and areas they have control over, and shifting negative assumptions of permanence to being less certain or temporary is another tool to enhance care.

**Social learning**

The information we take in from our environment and a range of social cues shape the response to placebo. Subjects in a trial were randomised to either receive a placebo, or receive a placebo after witnessing a group of actors first taking this and mimicking a very positive experience<sup>56</sup>. The subjects who witnessed the actors had a much more powerful response to the anxiolytic placebo. This is an example of social learning. Other environmental cues associated with enhanced response to placebo include office staff telling patients the doctor is great and seeing another patient leave the consulting room happy<sup>52,53,57</sup>. Rudeness is associated with poor performance in both cognitive and practical tasks<sup>58</sup>.

Comfortable rooms, brochures, pictures and positive stories of the experience of other patients are all social cues to enhance the effects of our powerful therapies.

**Practice tip 6:**

The cues and suggestions from other staff, patients and the environment, will also magnify or diminish the effects of our powerful therapies.

**The props**

Studies have shown red pills provide a larger placebo response for energy, blue pills for calm<sup>59</sup>. Injections were more effective than pills<sup>60</sup> and expensive therapy<sup>61</sup> also enhances this response. Ian Harris' book, *Surgery the Ultimate Placebo*<sup>62</sup>, describes one of the problems of surgical training is that trainees never see the powerful effects of sham surgery and hence never learn to question their own practice.

The change from a regular medication to a generic medication can have a great negative effect on patients and provoke a host of side effects<sup>63-65</sup>. How this change is introduced makes a big difference in the efficacy of the medication and its side effects. Interestingly, side effects from medication have been shown in trials to increase the response to placebo, possibly by convincing patients they are taking the active drug.

Recent studies exploring sham surgeries versus actual interventions have been published on sham surgery versus partial meniscectomy<sup>66</sup> in the NEJM and percutaneous coronary intervention in stable angina<sup>67</sup> in *The Lancet*. Both interventions were for pain, neither showed an advantage for active treatment over placebo, and both demonstrated the powerful expectations we generate from surgery – for both patients and practitioners.

**Choice**

Some studies have demonstrated a link between patients having choice and an increased response to placebo. For example, when a group of patients were told to expect a 25%, 50%, 75% or 100% response to a trial drug (which was a placebo), only the group that was told that there was a 75% chance of benefit showed a significant response<sup>68</sup>. This may show a distrust of absolute guarantees, such as a 100% response to medications.

**Which patients do well?**

In the US (but not in European trials), the placebo effect has increased with time<sup>69</sup>. Reasons put forward include direct advertising to consumers via the media and more patient contact, and positive interactions with trial staff aimed at stopping people from dropping out of trials. The stronger the placebo effect, the larger a trial has to be to demonstrate a response to therapy and hence the more expensive a trial becomes to show a positive result. This sparked research to identify the cohort that responds well to placebo with the hopes of excluding them from trials facilitating shorter, cheaper and easier clinical trials<sup>70</sup>.

One fascinating outcome of this and similar research was the discovery of traits associated with more powerful placebo responses<sup>67,71</sup> and that these are also often associated with a stronger response to pharmacotherapy. The placebo response, our learning and expectations magnify the pharmacological effects of the proven, powerful medications we use.

Traits linked to a strong placebo response, including an internal locus of control (the belief that a person can influence their own environment or destiny)<sup>71</sup>, expectations of a positive response and optimism, were not essential to getting a placebo response. However, those believing they had little influence over what happens to them, as well as those with impaired frontal lobe connectivity (including Alzheimer's disease)<sup>17</sup>, have reduced responsiveness to placebo. Of interest, some genetic factors associated with the body's endorphins have been studied and are also associated with increased or reduced responsiveness to placebo<sup>73,74</sup>.

The cohort that responds best to an active drug is also the cohort that gets the strongest response to placebo. Expectations and learning (the meaning of a health encounter) magnify the effects of our powerful medications.

**CONCLUSION**

The language we use and the expectations we shape have a powerful effect on enhancing or reducing the effectiveness of the medications we use. The interaction we have with patients is far from inert and is a powerful tool to enhance analgesia. A rapidly increasing placebo literature demonstrates multiple pathways are involved in generating this response, including endocannabinoid, endorphin and dopaminergic systems and the role of conditioning in developing these responses.

Many common medical cues and phrases such as informing people that an injection "will hurt" or is "just a little bee sting" reduce the effectiveness of our therapies and create hyperalgesia. These are often justified in the mistaken belief they are "honest."

Simple steps such as explaining the purpose of the medications we are giving, reframing suggestions, and replacing negative suggestions with positive ones make a huge difference to the analgesia people experience. These can be magnified or reduced by other factors such as trust and rapport with the doctor, cues from the wider environment, a sense of control and optimism.

For those interested in the placebo effect, I refer you to a range of excellent reviews by researchers such as Kaptchuk<sup>52</sup>, Schedlowski<sup>2</sup>, Colloca, Benedetti<sup>29,34</sup> and Australia's Damien Finniss<sup>31</sup>.

For those interested in practical, focused strategies to enhance communication, I refer you to the book *Handbook of Communication in Anaesthesia and Critical Care* by Cyna A, Andrew M, Tan S and Smith A; and the excellent workshops they run at ANZCA meetings while courses such as the South Australian Diploma in Hypnosis offer an even more advanced toolkit to use in a perioperative setting.

**REFERENCES**

1. WMA. World medical association declaration of Helsinki: Ethical principles for medical research involving human subjects Vol. 57, Journal of the Korean Medical Association. 2014 [cited 2021 Apr 7]. p. 899–902. Available from: <https://www.wma.net/policies-post/wma-declaration-of-helsinki-ethical-principles-for-medical-research-involving-human-subjects/>
2. Schedlowski M, Enck P, Rief W, Bingel U. Neuro-Bio-Behavioral mechanisms of placebo and nocebo responses: Implications for clinical trials and clinical practice. 2015; Available from: <http://dx.doi.org/10.1124/pr.114.009423>
3. Benedetti F, Mayberg HS, Wager TD, Stohler CS, Zubieta J-K. Neurobiological mechanisms of the placebo effect. *J Neurosci*. 2005;25(45):10390–402.
4. Levine JD, Gordon NC, Bornstein JC, Fields HL. Role of pain in placebo analgesia. *Proc Natl Acad Sci U S A*. 1979;76(7):3528–2531.
5. Beecher HK. The powerful placebo. *J Am Med Assoc*. 1955 Dec 24;159(17):1602–6.
6. Weimer K, Gulewitsch MD, Schlarb AA, Schwille-Kiuntke J, Klosterhalfen S, Enck P. Placebo effects in children: A review. Vol. 74, *Pediatric Research*. 2013. p. 96–102.
7. Elsenbruch S, Enck P. Placebo effects and their determinants in gastrointestinal disorders. Vol. 12, *Nature Reviews: Gastroenterology and Hepatology*. Nature Publishing Group; 2015. p. 472–85.
8. Petrovic P, Kalso E, Petersson KM, Ingvar M. Placebo and opioid analgesia – Imaging a shared neuronal network. *Science*; 2002 Mar 1;295(5560):1737–40.
9. Butler DS, Moseley GL. Explain Pain second edition. NOI Group: 2013. [cited 2021 Apr 7]. Available from: <https://www.noigroup.com/product/explain-pain-second-edition/>
10. Grace PM, Tawfik VL, Svensson CI, Burton MD, Loggia ML, Hutchinson MR. The Neuroimmunology of Chronic Pain: From Rodents to Humans. *J Neurosci* 2021 Feb 3 [cited 2021 Apr 7];41(5):855–65. Available from: <https://pubmed.ncbi.nlm.nih.gov/33239404/>
11. International Association for the Study of Pain (IASP) 2020.
12. Aslaksen PM, Bystad M, Vambheim SM, Flaten MA. Gender differences in placebo analgesia: Event-related potentials and emotional modulation. *Psychosom Med*. 2011 Feb [cited 2021 Apr 7];73(2):193–9. Available from: <https://pubmed.ncbi.nlm.nih.gov/21217098/>
13. Wager TD, Matre D, Casey KL. Placebo effects in laser-evoked pain potentials. *Brain Behav Immun*. 2006 May [cited 2021 Mar 6];20(3):219–30. Available from: [/pmc/articles/PMC3735137/](https://pubmed.ncbi.nlm.nih.gov/16364549/)
14. Price DD, Finniss DG, Benedetti F. A comprehensive review of the placebo effect: Recent advances and current thought. *Annual Review of Psychology*. Vol. 59, 2008. p. 565–90.
15. Bingel U, Lorenz J, Schoell E, Weiller C, Büchel C. Mechanisms of placebo analgesia: rACC recruitment of a subcortical antinociceptive network. *Pain*: 2006 Jan [cited 2021 Mar 6];120(1–2):8–15. Available from: <https://pubmed.ncbi.nlm.nih.gov/16364549/>
16. Wager TD, Rilling JK, Smith EE, Sokolik A, Casey KL, Davidson RJ, et al. Placebo-induced changes in fMRI in the anticipation and experience of pain. *Science* 2004. PMID: 14976306. 2004 Feb 20 [cited 2021 Apr 7];303(5661):1162–7. Available from: <https://pubmed.ncbi.nlm.nih.gov/14976306/>
17. Benedetti F, Arduino C, Costa S, Vighetti S, Tarenzi L, Rainero I, et al. Loss of expectation-related mechanisms in Alzheimer's disease makes analgesic therapies less effective. *Pain*. 2006 Mar [cited 2021 Mar 6];121(1–2):133–44. Available from: <https://pubmed.ncbi.nlm.nih.gov/16473462/>
18. Eippert F, Bingel U, Schoell ED, Yacubian J, Klinger R, Lorenz J, et al. Activation of the opioidergic descending pain control system underlies placebo analgesia. *Neuron*. 2009 Aug 27;63(4):533–43.
19. Geuter S, Eippert F, Hindi Attar C, Büchel C. Cortical and subcortical responses to high and low effective placebo treatments. *Neuroimage*. 2013 Feb 5;67:227–36.
20. Levine JD, Gordon NC, Fields HL. The mechanism of placebo analgesia. *Lancet*: 1978 Sep 23 [cited 2021 Mar 6];312(8091):654–7. Available from: <https://pubmed.ncbi.nlm.nih.gov/80579/>
21. Wager TD, Scott DJ, Zubieta JK. Placebo effects on human  $\mu$ -opioid activity during pain. *Proc Natl Acad Sci U.S.A*. 2007 Jun 26 [cited 2021 Apr 7];104(26):11056–61. Available from: <https://pubmed.ncbi.nlm.nih.gov/17578917/>
22. Amanzio M, Benedetti F. Neuropharmacological dissection of placebo analgesia: Expectation-activated opioid systems versus conditioning-activated specific subsystems. *J Neurosci*. 1999 Jan 1;19(1):484–94.
23. Lipman JJ, Miller BE, Mays KS, Miller MN, North WC, Byrne WL. Peak B endorphin concentration in cerebrospinal fluid: reduced in chronic pain patients and increased during the placebo response. *Psychopharmacology (Berl)*. 1990 Sep [cited 2021 Apr 7];102(1):112–6. Available from: <https://link.springer.com/article/10.1007/BF02245754>

24. Benedetti F, Amanzio M, Casadio C, Oliaro A, Maggi G. Blockade of nocebo hyperalgesia by the cholecystokinin antagonist proglumide. *Pain*. 1997 Jun;71(2):135–40.
25. Benedetti F, Amanzio M, Baldi S, Casadio C, Maggi G. Inducing placebo respiratory depressant responses in humans via opioid receptors. *European Journal of Neuroscience*. 1999 Feb;11(2):625–631.
26. Pollo A, Vighetti S, Rainero I, Benedetti F. Placebo analgesia and the heart. *Pain*. 2003 Mar 1;102(1–2):125–33.
27. Benedetti F, Amanzio M, Rosato R, Blanchard C. Nonopioid placebo analgesia is mediated by CB1 cannabinoid receptors. 2011 [cited 2021 Apr 9]; Available from: <http://www.nature.com/>
28. Scott DJ, Stohler CS, Egnatuk CM, Wang H, Koeppe RA, Zubieta JK. Individual differences in reward responding explain placebo-induced expectations and effects. *Neuron*. 2007 Jul 19 [cited 2021 Apr 7];55(2):325–36. Available from: <https://pubmed.ncbi.nlm.nih.gov/17640532/>
29. Colloca L, Sigaud M, Benedetti F. The role of learning in nocebo and placebo effects. *Pain*. 2008 May [cited 2021 Apr 7];136(1–2):211–8. Available from: <https://pubmed.ncbi.nlm.nih.gov/18372113/>
30. De la Fuente-Fernández R, Ruth TJ, Sossi V, Schulzer M, Calne DB, Stoessl AJ. Expectation and dopamine release: Mechanism of the placebo effect in Parkinson's disease. *Science*. 2001 Aug 10 [cited 2021 Apr 7];293(5532):1164–6. Available from: <https://pubmed.ncbi.nlm.nih.gov/11498597/>
31. Price DD, Finniss DG, Benedetti F. A comprehensive review of the placebo effect: Recent advances and current thought. *Annual Review of Psychology*. 2008 [cited 2021 Apr 7]; 59:565–90. Available from: <https://pubmed.ncbi.nlm.nih.gov/17550344/>
32. Leuchter AF, Cook IA, Witte EA, Morgan M, Abrams M. Changes in brain function of depressed subjects during treatment with placebo. *Am J Psychiatry*. 2002 Jan [cited 2021 Apr 7];159(1):122–9. Available from: <https://pubmed.ncbi.nlm.nih.gov/11772700/>
33. Goebel MU, Trebst AE, Steiner J, Xie YF, Exton MS, Frede S, et al. Behavioral conditioning of immunosuppression is possible in humans. *FASEB J*. 2002 Dec;16(14):1869–73.
34. Lanotte M, Lopiano L, Torre E, Bergamasco B, Colloca L, Benedetti F. Expectation enhances autonomic responses to stimulation of the human subthalamic limbic region. *Brain Behav Immun*. 2005 Nov [cited 2021 Apr 7];19(6):500–9. Available from: <https://pubmed.ncbi.nlm.nih.gov/16055306/>
35. Tekampe J, Van Middendorp H, Meeuwis SH, Van Leusden JWR, Pacheco-López G, Hermus ARMM, et al. Conditioning immune and endocrine parameters in humans: A systematic review. *Psychother Psychosom* 2017;86:99–107. Available from: <https://doi.org/10.1159/000449470>
36. Bingel U, Wanigasekera V, Wiech K, Mhuirheartaigh RN, Lee MC, Ploner M, et al. The effect of treatment expectation on drug efficacy: Imaging the analgesic benefit of the opioid remifentanyl. *Sci Transl Med*. 2011 Feb 16 [cited 2021 Apr 7];3(70):70ra14. Available from: <https://stm.sciencemag.org/content/3/70/70ra14>
37. Colloca L, Lopiano L, Lanotte M, Benedetti F. Overt versus covert treatment for pain, anxiety, and Parkinson's disease. *Lancet Neurol*. 2004 Nov 1 [cited 2021 Apr 7];3(11):679–84. Available from: <http://www.ncbi.nlm.nih.gov/pubmed/15488461>
38. Pollo A, Amanzio M, Arslanian A, Casadio C, Maggi G, Benedetti F. Response expectancies in placebo analgesia and their clinical relevance. *Pain*. 2001;93(1):77–84.
39. Benedetti F, Pollo A, Lopiano L, Lanotte M, Vighetti S, Rainero I. Conscious expectation and unconscious conditioning in analgesic, motor, and hormonal placebo/nocebo responses. *J Neurosci*. 2003 May 15 [cited 2021 Apr 7];23(10):4315–23. Available from: <https://www.jneurosci.org/content/23/10/4315>
40. Gracely RH, Dubner R, Deeter WR, Wolsklee PJ. Clinicians' expectations influence placebo analgesia: Vol. 325, *Lancet*; 1985 [cited 2021 Apr 7]. p. 43. Available from: <https://pubmed.ncbi.nlm.nih.gov/2856960/>
41. Lang E V, Hatsiopolou O, Koch T, Berbaum K, Lutgendorf S, Kettenmann E, et al. Clinical note: Can words hurt? Patient-provider interactions during invasive procedures. [cited 2021 Apr 7]; Available from: [www.elsevier.com/locate/pain](http://www.elsevier.com/locate/pain)
42. Cyna AM. Little words BIG impact: Perioperative communication for children with burns. *Anaesth Intensive Care*. 2020 Mar 1 [cited 2021 Apr 7];48(2):123–8. Available from: <http://journals.sagepub.com/doi/10.1177/0310057X20914909>
43. Cyna AM, Andrew MI, Tan SGM. Communication skills for the anaesthetist. *Anaesthesia*. 2009 Jun 1 [cited 2021 Apr 7];64(6):658–65. Available from: <http://doi.wiley.com/10.1111/j.1365-2044.2009.05887.x>
44. Chooi CSL, White AM, Tan SGM, Dowling K, Cyna AM. Pain vs comfort scores after Caesarean section: a randomized trial. *Br J Anaesth*. 2013 May 1 [cited 2021 Apr 7];110(5):780–7. Available from: <https://linkinghub.elsevier.com/retrieve/pii/S0007091217326764>
45. Dutt-Gupta J, Bown T, Cyna AM. Effect of communication on pain during intravenous cannulation: a randomized controlled trial. *Br J Anaesth*. 2007 Dec 1 [cited 2021 Apr 7];99(6):871–5. Available from: <https://linkinghub.elsevier.com/retrieve/pii/S0007091217359664>
46. Cyna AM. The lairs of hypnotic communication and the “Lived in Imagination” technique in Medical Practice. *Int J Clin Exp Hypn*. 2019 Jul 3 [cited 2021 Apr 7];67(3):247–61. Available from: <https://www.tandfonline.com/doi/full/10.1080/00207144.2019.1612669>
47. Giusti EM, Lacerenza M, Manzoni GM, Castelnuovo G. Psychological and psychosocial predictors of chronic postsurgical pain: a systematic review and meta-analysis. *Pain*. 2021 Jan 1 [cited 2021 Apr 7];162(1):10–30. Available from: <https://pubmed.ncbi.nlm.nih.gov/32694386/>
48. Schweiger A, Parducci A. Nocebo: The psychologic induction of pain. *Pavlov J Biol Sci*. 1981 Jul [cited 2021 Apr 7];16(3):140–3. Available from: <https://pubmed.ncbi.nlm.nih.gov/7290754/>
49. Lorimer Moseley G, Nicholas MK, Hodges PW. A Randomized Controlled Trial of Intensive Neurophysiology Education in Chronic Low Back Pain. *Clin J Pain*. 2004 Sep-Oct;20(5):324–30. doi:10.1097/00002508-200409000-00007.
50. Fiske ST, Cuddy AJC, Glick P. Universal dimensions of social cognition: warmth and competence. Vol. 11, *Trends in Cognitive Sciences*. Elsevier Current Trends; 2007. p. 77–83.

51. Howe LC, Leibowitz KA, Crum AJ. When your doctor “Gets it” and “Gets you”: The critical role of competence and warmth in the patient-provider interaction. *Front Psychiatry*. 2019 Jul 4 [cited 2021 Apr 7];10(July):475. Available from: [www.frontiersin.org](http://www.frontiersin.org)
52. Kaptchuk TJ, Kelley JM, Conboy LA, Davis RB, Kerr CE, Jacobson EE, et al. Components of placebo effect: Randomised controlled trial in patients with irritable bowel syndrome. *BMJ*. 2008 May 3 [cited 2021 Apr 7];336(7651):999–1003. Available from: <https://pubmed.ncbi.nlm.nih.gov/18390493/>
53. Fuentes J, Armijo-Olivo S, Funabashi M, Miciak M, Dick B, Warren S, et al. Enhanced therapeutic alliance modulates pain intensity and muscle pain sensitivity in patients with chronic low back pain: An experimental controlled study. *Phys Ther*. 2014;94(4):477–89.
54. Seligman MEP. Optimism, Pessimism, and Mortality. *Mayo Clin Proc*. 2000 Feb 1 [cited 2021 Apr 7];75(2):133–4. Available from: <http://www.mayoclinicproceedings.org/article/S0025619611641827/fulltext>
55. Seligman MEP. *Learned Optimism*. North Sydney NSW: Random House: 2011.
56. Faasse K, Grey A, Jordan R, Garland S, Petrie KJ. Seeing is believing: Impact of social modelling on placebo and nocebo responding. *Health Psychology*, 2015;34(8), 880–885. <https://doi.org/10.1037/hea0000199>
57. Colloca L, Benedetti F. Placebo analgesia induced by social observational learning. *Pain*. 2009 Jul [cited 2021 Apr 7];144(1–2):28–34. Available from: <https://pubmed.ncbi.nlm.nih.gov/19278785/>
58. Riskin A, Erez A, Foulk TA, Riskin-Geuz KS, Ziv A, Sela R, et al. Rudeness and medical team performance. *Pediatrics*. 2017 Feb 1 [cited 2021 Apr 7];139(2). Available from: <https://pubmed.ncbi.nlm.nih.gov/28073958/>
59. De Craen AJM, Roos PJ, De Vries AL, Kleijnen J. Effect of colour of drugs: Systematic review of perceived effect of drugs and of their effectiveness. *Br Med J*: 1996 [cited 2021 Apr 7];313(7072):1624–6. Available from: <https://pubmed.ncbi.nlm.nih.gov/8991013/>
60. De Craen AJM, Tijssen JGP, De Gans J, Kleijnen J. Placebo effect in the acute treatment of migraine: Subcutaneous placebos are better than oral placebos. *J Neurol*. 2000 [cited 2021 Apr 9];247(3):183–8. Available from: <https://pubmed.ncbi.nlm.nih.gov/10787112/>
61. Espay AJ, Norris MM, Eliassen JC, Dwivedi A, Smith MS, Banks C, et al. Placebo effect of medication cost in Parkinson disease: A randomized double-blind study. *Neurology*. 2015 Feb 24 [cited 2021 Apr 9];84(8):794–802. Available from: <https://n.neurology.org/content/84/8/794>
62. Harris I. *Surgery, the ultimate placebo: A surgeon cuts through the evidence*. New South Wales, Sydney (Australia): 2016.
63. Faasse K, Cundy T, Gamble G, Petrie KJ. The effect of an apparent change to a branded or generic medication on drug effectiveness and side effects. *Psychosom Med*. 2013 Jan [cited 2021 Apr 7];75(1):90–6. Available from: <http://www.ncbi.nlm.nih.gov/pubmed/23115341>
64. Colgan SLE, Faasse K, Pereira JA, Grey A, Petrie KJ. Changing perceptions and efficacy of generic medicines: An intervention study. *Heal Psychol*. 2016 Nov 1;35(11):1246–53.
65. Faasse K, Martin LR, Grey A, Gamble G, Petrie KJ. Impact of brand or generic labeling on medication effectiveness and side effects. *Heal Psychol*. 2016 Feb 1 [cited 2021 Apr 7];35(2):187–90. Available from: <https://pubmed.ncbi.nlm.nih.gov/26462056/>
66. Sihvonen R, Paavola M, Malmivaara A, Itälä A, Joukainen A, Nurmi H, et al. Arthroscopic partial meniscectomy versus sham surgery for a degenerative meniscal tear. *N Engl J Med*. 2013 Dec 26 [cited 2021 Apr 7];369(26):2515–24. Available from: <http://www.nejm.org/doi/10.1056/NEJMoa1305189>
67. Al-Lamee R, Thompson D, Dehbi HM, Sen S, Tang K, Davies J, et al. Percutaneous coronary intervention in stable angina (ORBITA): a double-blind, randomised controlled trial. *Lancet*. 2018 Jan 6 [cited 2021 Apr 7];391(10115):31–40. Available from: <http://www.thelancet.com/article/S0140673617327149/fulltext>
68. Lidstone SC, Schulzer M, Dinelle K, Mak E, Sossi V, Ruth TJ, et al. Effects of expectation on placebo-induced dopamine release in Parkinson disease. *Arch Gen Psychiatry*. 2010 Aug [cited 2021 Apr 7];67(8):857–65. Available from: <https://pubmed.ncbi.nlm.nih.gov/20679593/>
69. Tuttle AH, Tohyama S, Ramsay T, Kimmelman J, Schweinhardt P, Bennett GJ, et al. Increasing placebo responses over time in U.S. clinical trials of neuropathic pain. *Pain*. 2015 [cited 2021 Apr 9];156(12):2616–26. Available from: <https://pubmed.ncbi.nlm.nih.gov/26307858/>
70. Siberman S. Placebos are getting more effective. Drugmakers are desperate to know why. *Wired Magazine*. 2009 Aug 24. Available from: [powerofmindset.com](http://powerofmindset.com)
71. Horing B, Weimer K, Muth ER, Enck P. Prediction of placebo responses: a systematic review of the literature. *Frontiers in psychology*.2014;5:1079. Available from: <https://doi.org/10.3389/fpsyg.2014.01079>
72. Weimer K, Colloca L, Enck P. Placebo effects in psychiatry: Mediators and moderators. Vol. 2, *The Lancet Psychiatry*. Elsevier Ltd; 2015. p. 246–57.
73. Peciña M, Stohler CS, Zubieta JK. Neurobiology of placebo effects: Expectations or learning? *Soc Cogn Affect Neurosci*. 2014;9(7):1013–21.
74. Leuchter AF, McCracken JT, Hunter AM, Cook IA, Alpert JE. Monoamine oxidase a and catechol-o-methyltransferase functional polymorphisms and the placebo response in major depressive disorder. *J Clin Psychopharmacol*. 2009 Aug [cited 2021 Apr 7];29(4):372–7. Available from: <https://pubmed.ncbi.nlm.nih.gov/19593178/>

## Aue, Ta fia Ola! Pain and the faaSamoa

### Satualafaalagilagi Leinani Aiono-Le Tagaloa MBChB, FANZCA, FFPMANZCA

**Pain Specialist, Auckland Regional Pain Service; Anaesthetist, Auckland Hospital, New Zealand**

Satualafaalagilagi Dr Leinani Aiono-Le Tagaloa was born and brought up in Samoa (previously Western Samoa). In New Zealand she began surgical training then completed anaesthetic training. Having a FANZCA, she undertook an obstetric anaesthesia fellowship and assistant professorship in the United States. Upon returning to New Zealand, Satuala undertook a further fellowship in pain medicine and since obtaining her FFPMANZCA has split her work week between chronic pain at the Auckland Regional Pain Service and anaesthesia at Auckland Hospital. She serves ANZCA on the New Zealand National Committee and as an examiner for the Faculty of Pain Medicine. She is the founding president of the Pasifika Anaesthetists in Aotearoa.

### Brenda Cassidy, FANZCA, FFPMANZCA, MBBS

**Consultant anaesthetist in children's anaesthesia at the Women's and Children's Hospital and pain specialist at the Queen Elizabeth and Royal Adelaide hospitals and Aware Women's Health in Adelaide, SA and visiting specialist at the Alice Springs Hospital, NT**

Dr Brenda Cassidy is the section editor for pain management for *Australasian Anaesthesia*.

### INTRODUCTION BY DR BRENDA CASSIDY

I have for some years as the pain sub-editor, invited authors to write about the pain experience of the Indigenous Australasian cultures. It is with special thanks from me to Satuala that what follows is hopefully the first of a series of articles about pain in these cultures. Since our last edition of *Australasian Anaesthesia*, the International Association for the Study of Pain has expanded the definition of pain from the now well accepted 1979 definition to include six notes. I am taking the opportunity to list them here prior to this article about pain in Samoan culture.

#### **"Pain:**

An unpleasant sensory and emotional experience associated with, or resembling that associated with, actual or potential tissue damage.

#### **Notes:**

1. Pain is always a personal experience that is influenced to varying degrees by biological, psychological, and social factors.
2. Pain and nociception are different phenomena. Pain cannot be inferred solely from activity in sensory neurons.
3. Through their life experiences, individuals learn the concept of pain.
4. A person's report of an experience as pain should be respected.
5. Although pain usually serves an adaptive role, it may have adverse effects on function and social and psychological well-being.
6. Verbal description is only one of several behaviours to express pain; inability to communicate does not negate the possibility that a human or a nonhuman animal experiences pain.<sup>1,2"</sup>

Pain is learnt over a lifetime of experience and can be expressed in many ways. The more we as healthcare workers learn of pain in cultures within our region and show respect for all cultures, the more we can minimise the impact of pain on wellbeing in our communities.

The following article by Satuala is written such that the learning occurs during the development of the narrative. I encourage our readership to embrace the Samoan teaching style that is storytelling in nature and by the end urges the reader to ask questions of the author and of themselves.

“**Aue, ta fia ola!!! Auoi, alofa mai!!!**” Amidst the screams of indescribable pain, I could make out words as I ran towards the emergency room, words that shocked me, words that I had not heard uttered before in this hospital. It was three in the morning, another weekend on call for me covering both the emergency room and the operating theatre in this small town in the middle of the North Island of New Zealand. The weekends were long; 96-hour stretches of duty as a surgical registrar, often with only snatched moments of sleep and hurriedly grabbed mouthfuls of food between cases, and at times I felt more like I was hallucinating the scenes that passed before me. I wondered briefly if this was the case as I heard the screams rise again – undoubtedly in my mother tongue, this time piercing the sleep-deprived fog that was my brain so that there could be no denying that I was in fact hearing someone crying out in pain. Crying out in pain *in Samoan*. Crying out in absolute agony. The two impossibilities crashed together as I reached the resuscitation cubicle. The thrashing body on the stretcher, surrounded by burly orderlies and blue-suited policemen, all trying to keep the patient still so that the precious IV lines did not get ripped out. The mangled mess of what used to be legs, tightly wrapped in a MAST suit, and the tatau on what was visible of the man’s torso. I had barely registered these before the cries rose again. I responded without a second thought, throwing out a challenge and an answer to the cry for help, to the cry for life. “Sole! O le a le mea ua e leo tele ai?!” The man turned towards me and gasped, “Tuafafine!! Alofa mai a, alofa mai. loe, aue faamolemole ua ta fia ola!” I caught the hand that he stretched towards me and looked full into his eyes. “Ia ua lelei. Afai e te fia ola, tapuai mai!! Sei fai le galuega a fomai. Tapuai mai!”

Instantly he was silent, and still. Eerily the rest of the assessment was carried out to the accompaniment of the tersely delivered orders for blood, X-rays, massive transfusion, and anaesthetic management as the patient was transferred urgently to theatre, but it was as if the pain had suddenly and abruptly gone.

What had happened? I wondered that as I walked out of the hospital several hours later, wiped out after helping to stabilise the massive bleeding from a double above-knee amputation and arrange transfer of the now intubated patient to a tertiary centre for ICU admission and ongoing care. What had he been vocalising as he lay there screaming in pain? What had risen in me? What had I done? Why had I thrown out that challenge, and why had it had such a dramatic effect? I had spoken instinctively and intuitively when I heard those Samoan words, and remembered my reply with some horror, for it did not fit in with my training or what I had learned about doctor-patient communication. Yet I could not shake the feeling that something had occurred at a very visceral level, that belied the appearance of careless indifference, and in our exchange, he had somehow found a superhuman courage to bear unendurable pain.

I needed answers to what happened, and I turned to my mother for them. My mother, the late Aiono Dr Fanaafi Le Tagaloa, had spent her whole life first studying linguistics, and then studying, archiving, preserving, teaching, and living the faaSamoa (culture and traditions); the gagana Samoa (the language of our people). It is to her that I owe everything I am, and everything I know about the faaSamoa. She wept when I told my story to her.

Through the lens of our culture and traditions this is what happened.

“**Aue, ta fia ola!**” *Ta fia ola* – literally “I want to live”. But there is a depth of meaning beyond the literal words. It is an entreaty, an imploration for deliverance from certain peril. *Aue!* – hard to translate, it is a deep heart cry of distress, a word common to many Polynesian languages that finds its way into the expression of mourning, of grief for great loss, of absolute wretchedness. It is not easy for a Samoan to reach for these words – they represent the very end of one’s endurance. *Ta fia ola!* – I want to live! Death has me in its clutches. Endurance has found its limits and I am lost. Help me!

And my reply? One of the reasons I berated myself as I reflected on the events of the night, unable to sleep in my misery, was the seeming callousness of my response to a fellow human, a fellow Samoan’s suffering.

*Sole! “O le a le mea e te leotele ai?”*

A superficial translation could be “Hey man, why are you bellowing so much?” And if this translation stood, clothed as it were in the meaning and implication of callousness that the English words imply, I could rightly be judged as not worthy of my calling. Of being inhuman and unbelievably cruel. But he reached for my words gladly and responded:

‘*Tuafafine!*’ **Sister.**

‘*Alofa mai!!!*’ **Have compassion on me.**

‘*loe, aue, faamolemole ua ta fia ola!*’ **Yes, please I beg of you, I want to live!**

And with those words he was silent, concentrating on drawing upon every last ounce of will he had to bear the pain without crying out, putting himself into my hands, into the hands of the healers who could save his life, no longer in distress in his spirit even though physically nothing had changed.

In order to explain the significance of this connection, first I need to explain an important concept in the *faaSamoa* – one that underpins this and every other relationship and interaction in our world. This is the concept of the **Va**. On one level it simply means a gap, a parting of two elements that used to sit side by side, or a space that you can squeeze through. It has often been translated in English to “the space between us,” in order to convey its meaning in the context of human relationships. But it is far more than just a space. It is a deep mutual respect and regard, a haven where one human being offers another the honour of not treading harshly, or speaking inappropriately, or acting in a way that will bring harm. It defines the code of behaviour that is necessary for healthy and harmonious interactions – where language is carefully chosen, and actions are deliberate and considered.

Every interaction between one human being and another takes place in the **Va**. All relationships, from the family circle to the wider community, have their own rules of right conduct, that govern the appropriate way to communicate and show respect for each other. We are urged to *Tausi le va*, **care for the space between us**; to keep the peace, adhere to the right conduct, and to respect others at all times.

The story I have told is a beautiful example of the **Va** in action. I did not need to be a blood relative in order to be called sister; the deep application of the brother-sister **Va** was activated because in our society the right and respectful way for a man to treat a younger woman is as his sister; and the only way to respond to that is to honour it.

The sister-brother **Va** or relationship in the Samoan culture is arguably our most sacred, an enduring covenant that is binding and eternal between them. In fact, the sister is called *feagaiga*, **covenant**, and every Samoan male is brought up to cherish his sister and to defend and protect her, with his life if need be. It is a relationship of mutual honour and sacrifice, for in our ancient traditions the sister is the physician and healer, the conveyor of blessing or curse, the life giver. Through colonisation and the imposition of a Western construct, the sacred role of the sister as traditional healer has been lost, but it has not taken away the bond and the expectation that exists in the circle of this communion. The simple truth is this: when you are in need, your sister will rescue you; when you need courage, she will call forth from you the strength that will enable it. To carry such a weight of responsibility confers therefore a degree of freedom and privilege to the sister, and the authority to speak with directness and force when the situation calls for it. Instinctively I knew that, even though my Western-trained brain later recoiled at my seemingly harsh and inappropriate words.

My patient also knew and recognised that. He did not hear my words as unkind or cruel. Where the English translation implies heartlessness, the Samoan words convey kinship, relationship, and the offer of something beyond physical help; the offer of courage. He received the challenge and paused only to activate the covenant from me, his sister-healer, his *feagaiga*. Once assured of this he was silent, because to bear adversity with fortitude, with silence, is the highest attribute of courage that a Samoan can show. He was familiar with this, had been there before: and I knew this because of his *tatau*.

The *tatau*, the beautiful Samoan man’s half-body tattoo, is a living testament of courage in the face of pain. Traditionally, the *lagimalofie*, or rite of passage of the *tatau*, was mandatory for every Samoan male and marked the transition from childhood to manhood. In modern times it has experienced a renaissance and taken on a slightly different meaning, that of identification with being Samoan, but the message of the ability to bear pain is no less significant. It is *tapu* (taboo, unseemly) to cry out during the ritual of *tatau*, but one does not face this challenge alone. Those close to the recipient will offer exhortations and prayers, be present physically and lend the strength of their full support, for we believe that any undertaking as great as this is made possible by the joining of *mauli*, of souls, in united *tapuai*. The closest translation for the concept of *tapuai* is prayer – but it goes far deeper than uttered words or phrases. It is to give oneself in full union with another’s endeavours. The recipient himself lends his *tapuai* to the *tufuga*, the artist, to guide his hands and his tools to complete the *tatau* to the highest level.

A very similar transaction takes place when one goes to see a doctor, *sue fofa*, to receive treatment for an illness. There is an unspoken, subconscious contract between patient and healer, where the patient, along with their family members, lend their *tapuai* to the doctor, believing implicitly that this will assist in the process that will bring life, healing, and deliverance from pain. The doctor also promises to do their best, not only in the application of their

knowledge, skill and craft. It is equally as important to bear witness, to truly see and hear a patient's narrative, to validate their suffering, and to acknowledge their courage in enduring it. When the doctor demonstrates that living connection and willingness to truly hear, the Samoan patient will respond by giving the greatest gift they can, the courage that bears and endures pain.

As I journeyed through pain training, I came across the concept of placebo, not as “sham” treatment as I had understood it throughout medical school, but as the effect of the context in which a therapy was delivered, and a meaningful part of the treatment. It was fascinating to discover that the ways in which a treatment is delivered could account for up to 30 per cent of its effectiveness<sup>3</sup>, and that the converse was also true: nocebo, the negative effect of the way in which treatments are delivered, could work to reduce the therapeutic benefit<sup>2</sup>. Wager et al (2015)<sup>4</sup> in a review published in *Nature Reviews Neuroscience*, described elements of the treatment context as being composed of external context (place cues, verbal suggestions, gaze and body language and social interactions) and internal context, being the patient's expectations, emotions, explicit memories and sense of being cared for. According to Carlino and Benedetti (2016)<sup>5,6</sup>, contexts inducing positive expectations were associated with activation of specific systems (for example, opioid, cannabinoid and dopaminergic systems) and the involvement of prosocial hormones (for example, oxytocin and vasopressin). Conversely, negative contexts produced pain exacerbation, via activation of the CCK system and deactivation of opioid and dopaminergic systems, as well as the enhancement of the cyclooxygenase-prostaglandins pathway.

I was intrigued. I had carried the memory of that night deep inside me for many years, and now I saw that the impact of that interaction had its basis in something very deeply human. Speaking his language, knowing what to say and do, being the right person at the right time enabled that man to do the impossible and deal with the burden of extreme pain in a way that brought dignity and meaning to his suffering. In the language of placebo, our interaction induced a powerful positive expectation, with an overwhelmingly positive result for him. I was very privileged to have been explicitly taught the faaSamoa and gagana Samoa, our traditions and language, and to have been so immersed in it that I knew what to do and say without needing to cognitively process my reaction, when the moment arose.

I wanted to be able to do this for all my patients, and to be able to explain to my colleagues how to reach Samoan people who are in pain, using an understanding of our culture as a tool. But how could I possibly explain and teach something that I had absorbed and grown in? How could I make explicit something that was visceral and subliminal? And how could I ever learn the nuances of culture and language of the dozens of different people groups that I encountered each day? Surely such a task is impossible!

Again, I found the answer in the research on placebo mechanisms. The doctor-patient relationship as described by Benedetti (2013)<sup>6</sup> sounded very much like what I had observed and learnt as a Samoan: the role of the doctor is not only to be proficient in technical skills. It is equally important to see the patient in all their humanity, to pay attention to words and body language, to reassure and to listen; because the way in which patient care is delivered is part of the treatment. This transcends culture and language and provides us as doctors with the opportunity to truly call ourselves physicians, for whoever we are called upon to treat.

Nowhere is this more evident than in our response to a patient in pain, whether it is the acute pain of trauma and surgery, or the complex multi-faceted beast that is chronic pain. The IASP defines pain as “An unpleasant sensory and emotional experience associated with, or resembling that associated with, actual or potential tissue damage!” If our interactions with our patients can so powerfully influence their experiences, we may in fact hold one of the keys to the treatment of pain, in paying attention to the context. And just maybe we can influence the development of persistent pain, particularly post-surgical pain, as well.

*Aue, ta fia ola! Auoi alofa mai! I want to live; have compassion on me!* It could be said that this is the unspoken wish of every person seeking help for the pain and suffering they feel when ill, no matter how they express it. As doctors we must learn to hear it and learn how to respond, being aware that how we respond will make a world of difference.

Soifua ma ia manuia.

## ACKNOWLEDGEMENTS

First and foremost to my parents, Susuga Aiono Dr Fanaafi Le Tagaloa, and Hon Le Tagaloa Dr Pitapola Alailima, for teaching me, guiding me and loving me. My sisters, Leota Donna Ioane and Tootooloaava Fanaafi for moral support, editing and inspiration. Special thanks to Dr Malcolm Stewart for encouraging me to keep writing when I thoroughly doubted myself!

## REFERENCES

1. Raja, S N et al (2020) The revised International Association for the Study of Pain definition of pain: concepts, challenges, and compromises, *Pain* Vol 161 – Issue 9 – p 1976-1982
2. <https://www.iasp-pain.org/publications/iasp-news/iasp-announces-revised-definition-of-pain/>
3. Wager, T., Atlas, L. (2015) The neuroscience of placebo effects: connecting context, learning and health. *Nat Rev Neurosci* 16, 403–418. doi:10.1038/vpv3976
4. Tracey I. (2015) Getting the pain you expect: mechanisms of placebo, nocebo and reappraisal effects in humans. *Nat Med* 16, 1277-1283. doi:10.1038/nm2229
5. Carlino, E., Benedetti, F. (2016) Review. Different contexts, different pains, different experiences. *Neuroscience* 338, 19-26. doi:10.1016/j.neuroscience.2016.01.053
6. Benedetti, F. (2013) Placebo and the new physiology of the doctor-patient relationship. *Physiol Rev* 93: 1207–1246, doi:10.1152/physrev.00043.2012



# Obstetrics and gynaecology

**Nitrous oxide use on the labour ward:  
Efficacy and environmental impact**

Alice Gynther, Fiona Pearson, Forbes McGain

---

**Epidural labour analgesia: Current trends,  
advances, and future techniques**

Victor Chen, Harriet Wood

---

**Labour epidural injustice**

Ian Maddox

---



## Nitrous oxide use on the labour ward: Efficacy and environmental impact

### Alice Gynther MBBS, FANZCA

Western Health, Melbourne, Victoria

Dr Alice Gynther is an anaesthetist at Western Health with interests in obstetric anaesthesia and environmental sustainability in healthcare.

### Fiona Pearson, MBBS, MRCP, FRCA

Sunderland Royal Hospital, Sunderland, UK

Dr Fiona Pearson is a consultant anaesthetist who recently served as the Obstetric Anaesthetists' Association's trainee representative. In addition to obstetric anaesthesia, she has an interest in environmental sustainability.

### Forbes McGain FANZCA, FCICM, PhD

Departments of Anaesthesia and Intensive Care, Western Health, Melbourne, Victoria

Associate Professor Forbes McGain, Department of Critical Care, University of Melbourne, and School of Public Health, University of Sydney. He is keenly involved in the Doctors for the Environment Australia (DEA), advocating for a more environmentally sustainable healthcare system.

## INTRODUCTION

*You are attending a call for a patient who has requested a labour epidural. As you enter the birthing room you see a distressed woman breathing heavily on the nitrous oxide mouth-piece. The midwife tells you the woman has received intramuscular (IM) morphine about two hours prior. As you set up your equipment you wonder "just how effective is nitrous oxide for labour pain?"*

The analgesic, anxiolytic and amnesic properties of nitrous oxide ( $N_2O$ ) have been utilised in dentistry and surgery as far back as the mid-1800s making it one of the oldest anaesthetic agents still in use. Its low blood:gas coefficient and the second gas effect made it ideal for use with early volatile agents such as halothane and enflurane<sup>1</sup>. The intraoperative use of  $N_2O$  has reduced over time, in part due to concerns regarding an association with adverse cardiovascular events. This was subsequently refuted by the ENIGMA-II trial<sup>2</sup>. The introduction of agents with lower solubility, such as sevoflurane, and total intravenous anaesthesia (TIVA) also contributed to this trend<sup>1</sup>.  $N_2O$  has been used for labour analgesia in Australia since the 1950s<sup>3</sup> and is still commonly used to manage labour pain<sup>4</sup>.

## WHERE IS NITROUS OXIDE USED WITHIN OUR HOSPITALS?

Surprisingly, there is a paucity of data about where  $N_2O$  is being used in modern healthcare systems. Unlike some countries, in Australia the ambulance service does not use  $N_2O$ , administering the potent analgesic methoxyflurane instead<sup>5</sup>. It is also uncommon to use  $N_2O$  to provide sedation for endoscopy procedures in Australia, whereas it is commonly utilised for this purpose in the United Kingdom (UK). Observational studies of  $N_2O$  use in Australian hospitals are nearing completion at Western Health, Melbourne, and King Edward Memorial Hospital, Perth. We have recently participated in an audit at two connected hospitals (Sunshine/Joan Kirner hospitals) to ascertain the relative proportion of  $N_2O$  use in different hospital areas; labour ward (6000 births per year), operating theatres (11 theatres including paediatrics), and the paediatric emergency department. Preliminary results indicate the majority of  $N_2O$  is used on the labour ward with very minimal theatre use and, concerningly, a significant amount is likely being lost due to leaks from cylinder manifolds and pipelines. A  $N_2O$  mitigation project in NHS Lothian (Scotland) found cylinder manifold leaks to be a common problem<sup>6</sup>.

In the Joan Kirner hospital labour ward (Melbourne, Australia) in 2020, 62 per cent of women used  $N_2O$ , and 40 per cent of these also received epidural analgesia; figures in keeping with the national average. The Australian Institute of Health and Welfare reported that 53 per cent of women used  $N_2O$  for labour analgesia making it the most commonly used analgesic, with regional anaesthesia being used by 40 per cent of labouring women and systemic opioids by 14 per cent<sup>4</sup>. Although there is much variation in  $N_2O$  use in anaesthesia both within<sup>7</sup> and between<sup>8</sup> nations,  $N_2O$  may be used more widely outside of operating theatres worldwide.

## HOW EFFECTIVE IS NITROUS OXIDE FOR LABOUR ANALGESIA?

A literature search was conducted using MEDLINE, Cochrane and Embase databases with the following MESH terms and keywords (in titles or abstracts) used: nitrous oxide (Entonox®, laughing gas), (labor\* or labour\*, obstetric), (women or woman or pain\*), remifentanyl, morphine, pethidine (meperidine), fentanyl, desflurane, sevoflurane, methoxyflurane (penthrox), (epidural analgesia/anaesthesia), neuraxial, placebo/placebo effect, (analgesics, opioid), PCA, transcutaneous electric nerve stimulation, massage.

### Overall evidence for efficacy

A 2014 systematic review assessed available literature concerning N<sub>2</sub>O for labour analgesia and maternal satisfaction<sup>9</sup>. The authors noted insufficient strength of evidence for N<sub>2</sub>O with respect to labour analgesic efficacy and low strength of evidence for satisfaction. Out of 58 publications included, they noted a paucity of good quality studies (n=2), concluding that further research was needed to establish the efficacy and adverse effects of N<sub>2</sub>O in labour<sup>9</sup>.

### Nitrous oxide versus placebo

With the exception of one study showing no difference in pain scores<sup>10</sup>, randomised controlled trials (RCTs) comparing N<sub>2</sub>O to placebo (compressed air or oxygen) or no treatment found statistically significant mild reductions in pain intensity in N<sub>2</sub>O groups<sup>11</sup>. N<sub>2</sub>O was associated with significant increases in nausea, vomiting and dizziness in a number of studies<sup>11</sup>.

### Nitrous oxide versus epidural analgesia

Level I and II studies comparing N<sub>2</sub>O to epidural analgesia found uniformly lower pain intensity scores in the epidural groups<sup>9,12</sup>. Although a majority of trials reported higher satisfaction scores in epidural groups<sup>12</sup>, an exception was a cross-sectional study assessing women at two months post-partum which found more women rated their birth experience as positive/very positive with N<sub>2</sub>O compared to epidural analgesia<sup>13</sup>. However, this study also found N<sub>2</sub>O to be associated with a negative birth experience on second regression analysis<sup>13</sup>.

A study to assess efficacy and satisfaction with labour analgesia interviewed 6242 women following vaginal delivery<sup>14</sup>. Of women who received epidural anaesthesia (either solely or as conversion from N<sub>2</sub>O), 92 per cent rated their analgesia with “high effectiveness”, and >95 per cent rating “high” satisfaction with anaesthetic care. Of those using N<sub>2</sub>O alone, only 52 per cent reported “high effectiveness” but 93 per cent still reported high satisfaction<sup>14</sup>. The authors identified that satisfaction does not solely depend on analgesic efficacy.

### Nitrous oxide versus volatile agents

A 2012 Cochrane review of inhalational agents for labour analgesia concluded that flurane derivatives (enflurane, isoflurane, sevoflurane) resulted in superior pain relief compared to N<sub>2</sub>O but no difference in maternal satisfaction<sup>11</sup>. Flurane derivatives are no longer routinely used for labour analgesia due to their propensity to cause sedation. Four RCTs of lesser methodological quality compared N<sub>2</sub>O to methoxyflurane in labour<sup>9,11</sup>, with one trial finding methoxyflurane resulted in statistically significant superior analgesia<sup>15</sup>. The remaining trials found no significant differences between agents. In one of these, more women preferred N<sub>2</sub>O which the authors attributed to differences in the breathing apparatus used<sup>16</sup>.

### Nitrous oxide versus remifentanyl patient-controlled analgesia

A double-blinded RCT of 20 patients comparing remifentanyl patient-controlled analgesia (PCA) with intermittent N<sub>2</sub>O inhalation during the first stage of labour reported superior analgesia in those receiving remifentanyl PCA<sup>17</sup>. Larger studies of remifentanyl PCA in labour have found episodes of desaturation are common, necessitating one-on-one midwifery care, continuous monitoring, and provision of supplemental oxygen as required<sup>18</sup>. Outside of clinical trials, there have been case reports of maternal respiratory depression due to remifentanyl PCA<sup>19</sup>.

### Nitrous oxide versus intramuscular opioids

Randomised controlled trials comparing N<sub>2</sub>O to parenteral pethidine found lower pain intensity scores in N<sub>2</sub>O groups<sup>20</sup>. No studies comparing N<sub>2</sub>O with intramuscular morphine or subcutaneous fentanyl boluses were found.

### Effect of nitrous oxide on maternal request for epidural analgesia

Although N<sub>2</sub>O is very commonly used for labour analgesia in Australia, New Zealand and the UK, it was only used in three centres in the USA before 2011<sup>21</sup>. Since then, its use has rapidly increased to more than 500 birthing centres and hospitals<sup>21</sup>. An impact study was conducted before and after N<sub>2</sub>O (as self-administered Entonox® (50:50 N<sub>2</sub>O:O<sub>2</sub>)) was introduced as an option for labour analgesia in a hospital with more than 7000 deliveries per year. Despite 18 per cent of women in the “post group” using N<sub>2</sub>O, the epidural rate did not change significantly (77 per cent pre-N<sub>2</sub>O and 74 per cent post-N<sub>2</sub>O)<sup>22</sup>.

In summary, the analgesic effect of N<sub>2</sub>O appears greater than placebo and pethidine but inferior to volatile anaesthetics, remifentanyl PCA and epidural analgesia. In some studies, it is associated with a positive birth experience/satisfaction. The RANZCOG patient information on N<sub>2</sub>O nicely summarises that it “helps take the edge off pain, makes women feel in control of their pain relief and provides them with something to focus on to get through each contraction”<sup>23</sup>.

## THE ENVIRONMENTAL IMPACT OF NITROUS OXIDE

Nitrous oxide is a potent greenhouse gas (GHG); it absorbs atmospheric infrared radiation, trapping heat with a cumulative global warming effect and resultant climate change. This has several adverse health implications including heatwave-related cardiovascular compromise, respiratory disease related to air pollution and altered patterns of infectious diseases<sup>24</sup>. These concerns have been summarised as part of commitments to environmentally sustainable practice in several anaesthesia statements, including the American Society of Anesthesiologists (ASA)<sup>25</sup>, the European Society of Anaesthesiologists (ESA)<sup>26</sup>, and the Australian and New Zealand College of Anaesthetists (ANZCA) Statement on environmental sustainability in anaesthesia and pain medicine practice<sup>27</sup>.

The atmospheric heat absorbed by a given substance in relation to that of carbon dioxide (CO<sub>2</sub>) is referred to as its global warming potential (GWP). The time period commonly used for GWPs is 100 years and so it is expressed as the GWP<sub>100</sub>. As CO<sub>2</sub> is the reference gas, it has a GWP<sub>100</sub> of 1. Nitrous oxide has a GWP<sub>100</sub> of 265<sup>28</sup> reflecting its long atmospheric lifetime of 114 years<sup>24</sup>. By comparison, the GWP<sub>100</sub> of sevoflurane and desflurane are 130 and 2540 respectively<sup>29</sup>. As N<sub>2</sub>O is used in high concentrations clinically, when calculated over 100 years, its carbon impact is similar to that of desflurane<sup>30</sup>. A relatable value is that delivering 0.5 L/min N<sub>2</sub>O for one minute produces roughly the same carbon dioxide equivalence (CO<sub>2</sub>e) emissions as driving an average car one kilometre<sup>31</sup>. Furthermore, it is unclear what the environmental effects of N<sub>2</sub>O manufacture, distribution, and hospital pipelines are.

The World Meteorological Organization indicates that globally N<sub>2</sub>O represents 7 per cent<sup>32</sup> of all long-lived greenhouse gases (LLGHG) which together result in radiative forcing (inward radiative energy to the earth minus outgoing). This makes N<sub>2</sub>O the third most important LLGHG following CO<sub>2</sub> and methane which account for 66 per cent and 16 per cent of global warming respectively<sup>32</sup>. More than 1 per cent of worldwide GHG emissions resulting from N<sub>2</sub>O are anaesthetic in origin<sup>33,34</sup>, which is a substantial figure, given that a total of 40 per cent of global N<sub>2</sub>O is anthropogenic<sup>32</sup>. Healthcare accounts for 7 per cent of the total CO<sub>2</sub> emissions in Australia<sup>35</sup> and 6 per cent in England<sup>33</sup>. The NHS Lothian project estimated that more than three quarters of their “anaesthetic gas” carbon footprint was attributable to N<sub>2</sub>O product emissions<sup>6</sup>.

Unlike sevoflurane and desflurane, N<sub>2</sub>O contributes to stratospheric ozone layer depletion. The Montreal Protocol of 1987 mandated the phasing out of ozone depleting substances (ODS) allowing the ozone layer to recover. Ninety-eight per cent of included ODS were successfully phased out due to the agreement<sup>36</sup>. Nitrous oxide was not included in the Montreal Protocol and is now considered to be the largest global contributor to ozone depletion<sup>37</sup>. A reduction in N<sub>2</sub>O would therefore have dual benefits; ozone layer recovery and reducing greenhouse gas emissions.

### How does the life cycle assessment of nitrous oxide compare to other agents?

There are a variety of pharmaceutical options for labour analgesia and specific regimens vary between hospitals. Parenteral opioid options include morphine, pethidine and fentanyl, as well as intravenous patient-controlled analgesia (PCA) with remifentanyl or fentanyl. Epidural solutions typically contain bupivacaine or ropivacaine with fentanyl and epidural regimens include programmed intermittent epidural boluses, background infusions and patient bolus options.

Life cycle assessment (LCA) is a method used to estimate the environmental impact of different products including raw material extraction, manufacture, transportation and eventual use and disposal; from “cradle-to-grave”. LCA provides meaningful comparison of different agents with respect to their carbon footprint.<sup>33</sup>

The CO<sub>2</sub> equivalents (CO<sub>2</sub>e) for delivering commonly used labour analgesics in Australia were calculated by considering the carbon impact of the drugs, oxygen, equipment, energy to power the pumps and waste management. Active labour (from 4 cm cervical dilatation) is approximately 5.5 hours in primiparous women and four hours in multiparous women<sup>38</sup>, so our calculations were based on a four-hour period of analgesia. For N<sub>2</sub>O we have assumed it was delivered 50:50 with oxygen via a demand valve and mouthpiece and considered scope 1 (direct release to the atmosphere from the hospital) greenhouse gas protocol emissions. Calculations were based on a 70 kg woman (14 litres.min<sup>-1</sup> minute ventilation)<sup>39</sup> inhaling Entonox® for 60 seconds per contraction and having three contractions every 10 minutes (18 minutes use per hour). It was assumed that a maximum of two 10 mg doses of intramuscular or subcutaneous morphine<sup>40</sup> was administered. Fentanyl PCA calculations were based

on a 20 microgram bolus delivered every five minutes<sup>41</sup>, and remifentanyl PCA calculations were based on a 40 microgram bolus delivered every two minutes, both with two litres.min<sup>-1</sup> supplemental oxygen via nasal prongs<sup>42</sup>. Epidural regimens studied were 0.1 per cent bupivacaine with 2 mcg.ml<sup>-1</sup> fentanyl 30 ml.hr<sup>-1</sup> and 0.1% ropivacaine with 2 mcg.ml<sup>-1</sup> fentanyl 34 ml.hr<sup>-1</sup>.<sup>43,44</sup> A 20 mL loading dose of epidural solution and 1 per cent lidocaine (lignocaine) 10 mL for skin infiltrative anaesthesia were included in the calculations.

Carbon emissions for the local anaesthetics, fentanyl, and remifentanyl were taken from LCA data by Parvatker et al<sup>45</sup>. As Parvatker et al only considered GHG emissions relating to the active pharmaceutical product<sup>45</sup> their result was 25 per cent lower than that by McAlister et al<sup>46</sup> whose LCA of morphine from poppy farming included product sterilisation and packaging. We based our morphine calculations on the higher CO<sub>2</sub>e. It is worth noting that the values used for the local anaesthetics, fentanyl, and remifentanyl will be greater once packaging and sterilisation are taken into account.

Carbon equivalents for individual components (mouthpiece, needles, syringes, tubing and contents, sterile single-use drapes, gown and gloves for epidural insertion) were estimated from the weight, primary material and established GHG emission factors<sup>47-49</sup>. The GHG emission factor relating to the electricity required to power the epidural and PCA pumps was taken from Australian (Victorian) figures based on approximately 75 per cent electricity being generated via coal<sup>50</sup>. It was assumed that all disposables would enter the clinical waste stream and be treated by high temperature incineration and that packaging would be treated as domestic waste, processed by low temperature incineration<sup>51</sup>.

**Figure 1. Total carbon dioxide emissions of different labour analgesics over four hours**

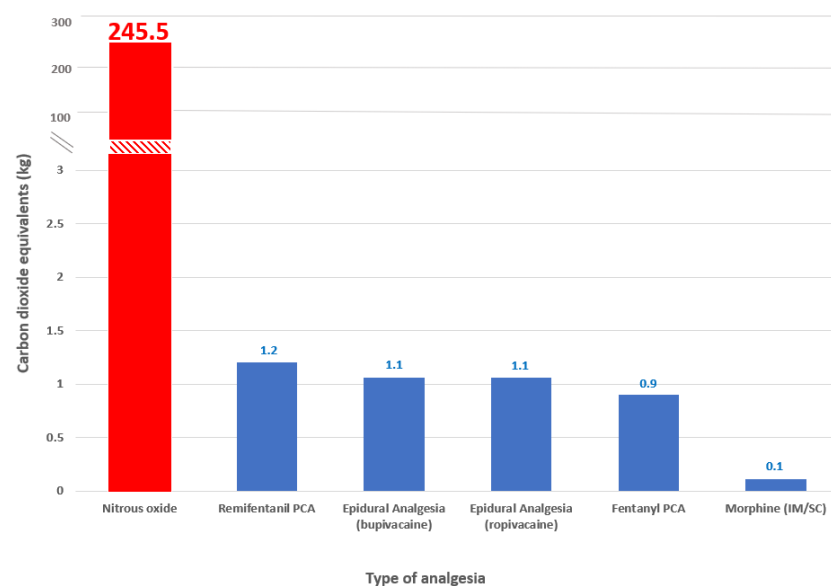

This figure shows the total CO<sub>2</sub>e emissions for each form of labour analgesia. Intermittent use of N<sub>2</sub>O (with oxygen) for four hours during labour is associated with a CO<sub>2</sub>e similar to driving almost 1500 kilometres in an average car (0.168 kgCO<sub>2</sub>e/km)<sup>49</sup>, compared to 6 kilometres for epidural analgesia (0.1 per cent bupivacaine with 2 mcg.ml<sup>-1</sup> fentanyl 30 ml.hr<sup>-1</sup>, or 0.1 per cent ropivacaine with 2 mcg.ml<sup>-1</sup> fentanyl 34 ml.hr<sup>-1</sup>), 7 kilometres for remifentanyl patient controlled analgesia (PCA), 5 kilometres for fentanyl PCA and 0.6 kilometres for intramuscular/subcutaneous (IM/SC) morphine. In order to demonstrate the relative differences in labour analgesia, please note that the y-axis scale changes and reaches a maximum of 300kgCO<sub>2</sub>e to accommodate the magnitude of the nitrous oxide emissions.

The impact of each element of labour analgesia is shown in Figure 2. For nitrous oxide, GHG emissions relating to the direct CO<sub>2</sub>e emissions from the gas itself is the largest contributor to its carbon impact. For all other forms of labour analgesia, the CO<sub>2</sub>e of the drugs is minimal and it is either the oxygen (for remifentanyl PCA) or equipment (syringes, and so on.) required that is associated with the highest environmental impact.

**Figure 2. Carbon impact of non-pharmaceutical elements of labour analgesia**

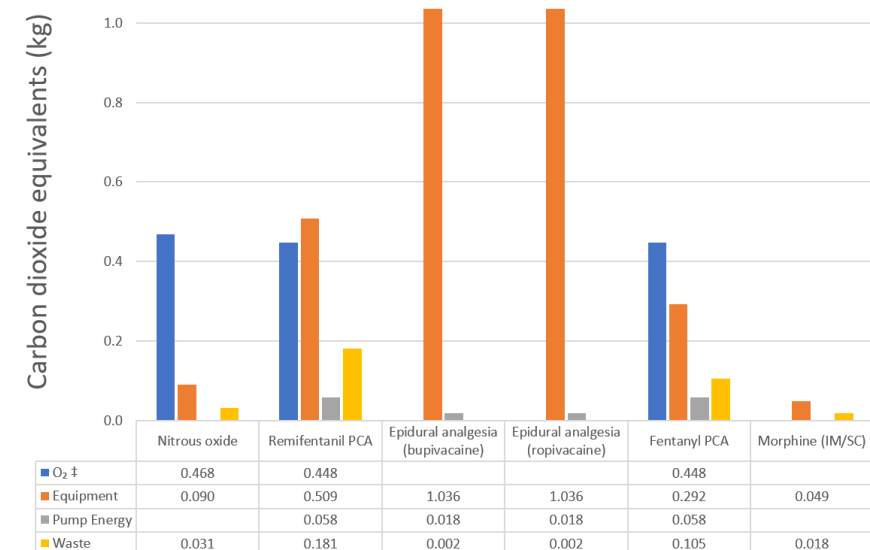

‡ 1 kWh per 1000 L O<sub>2</sub> compression and delivery. Ecoinvent database version 2.

Wernet G, Bauer C, Steubing B, Reinhard J, Moreno-Ruiz E, Weidema B. The ecoinvent database version 3 (part I): overview and methodology. International Journal for Life Cycle Assessment 2016; 21:1218–30. Assuming two L.min<sup>-1</sup> during remifentanyl/fentanyl PCA use. Epidural Analgesia (bupivacaine) = 0.1% bupivacaine plus 2 mcg.ml<sup>-1</sup> fentanyl at 30 mL.hr<sup>-1</sup>. Epidural Analgesia (ropivacaine) = 0.1% ropivacaine plus 2 mcg/ml fentanyl at 34 mL.hr<sup>-1</sup>

## WHAT CAN WE DO TO REDUCE AND/OR MITIGATE NITROUS OXIDE EMISSIONS?

### Reduce nitrous oxide use

Ensuring that midwifery, obstetric and anaesthetic staff are aware of the environmental impact of N<sub>2</sub>O is crucial. Raising awareness of nitrous oxide's GHG effects may change the way it is utilised, as we have seen in the case of desflurane use in anaesthetics<sup>52</sup>. While some hospitals solely use Entonox® (50:50 N<sub>2</sub>O:O<sub>2</sub>), others have delivery systems with a blender allowing up to 75 per cent N<sub>2</sub>O to be delivered. Inhaling 75 per cent N<sub>2</sub>O during labour results in the release of 5.1 kgCO<sub>2</sub>e per minute compared to 3.4 kgCO<sub>2</sub>e per minute for 50 per cent. A study comparing 50 per cent, 60 per cent and 70 per cent N<sub>2</sub>O in 501 parturients reported no significant difference in analgesic efficacy<sup>53</sup>. A smaller study suggested that there was a positive association between higher N<sub>2</sub>O concentrations and degree of pain relief<sup>54</sup>. In the absence of a consensus, high concentrations of N<sub>2</sub>O should be avoided where possible.

An important factor affecting women's birth experiences is perceived involvement in medical decision-making<sup>55</sup>. In order to support women's autonomy and help them make informed choices regarding their labour analgesia, we have a duty to explain the risks and benefits of the different analgesic options. As climate change is a threat to public health<sup>56</sup>, the carbon footprint of N<sub>2</sub>O is arguably a "risk" worthy of inclusion in such discussions. Ideally such discussions would occur during antenatal classes, that is, well prior to childbirth itself. This knowledge, coupled with the lack of good evidence for nitrous oxide's analgesic efficacy, may reduce the number of women choosing to use it for labour.

Pain perception and intensity during labour is highly variable and can be influenced by a multitude of factors. In addition to perinatal aspects such as parity, fetal presentation and augmentation of labour, psychosocial experiences can play a significant role<sup>56</sup>. Women may choose non-pharmacological interventions, aimed at helping them cope with labour pain (the "working with pain paradigm") or may request pharmacological interventions with the intention of relieving it (the "pain relief paradigm").

The relationship between patient satisfaction and analgesic effectiveness was explored in a qualitative study of 678 women using N<sub>2</sub>O during labour<sup>57</sup>. Only 35 per cent described "high" analgesic effectiveness despite 90 per cent reporting high satisfaction<sup>57</sup>. Patient satisfaction was attributed to the N<sub>2</sub>O providing a distraction/dissociation from pain, helping them cope with labour (distinct from providing analgesia) and encouraging them to focus on their breathing. Continuous midwifery support and adoption of hypnobirthing techniques would

be an alternative way of providing this support. A systematic review on maternal satisfaction with childbirth identified that caregiver support and quality of care-giver relationship were two of the key factors highly associated with satisfaction<sup>55</sup>. The remaining two factors; personal expectations and involvement in decision-making can be addressed with informed discussions as previously mentioned<sup>55</sup>. Other non-pharmacological methods of managing labour pain could also be considered. Cochrane reviews have shown that acupuncture versus sham can improve maternal satisfaction with labour analgesia<sup>58</sup> (albeit with no change in pain intensity), and there is low quality evidence that massage reduces pain in the first stage of labour compared to standard care<sup>59</sup>. RCTs have found no difference in analgesic efficacy between N<sub>2</sub>O and transcutaneous electric nerve stimulator (TENS)<sup>60,61</sup>.

Bolus opioids, remifentanyl PCA and epidural analgesia all have a favourable carbon impact compared to N<sub>2</sub>O. While remifentanyl PCA and epidural offer improved analgesia compared to N<sub>2</sub>O and bolus opioids, they are not available in all birth settings. Advising women that low concentration epidural solutions result in less motor block and reduced instrumental deliveries compared to previous regimens<sup>62</sup>, may allay some of the apprehensions around epidural analgesia. Where possible, if a woman requests epidural analgesia, offering this early in labour could reduce the volume of nitrous oxide consumed.

Methoxyflurane is a potential alternative to N<sub>2</sub>O oxide for labour analgesia and was commonly used for this purpose in the 1960s. Methoxyflurane has a very low GWP of 4 with an atmospheric lifetime of only 54 days<sup>63</sup> and therefore would result in considerably lower carbon equivalents if used in place of N<sub>2</sub>O. The Pentrox™ hand-held inhaler contains 3mL methoxyflurane and has been used for acute trauma in Australia since the 1970s. More than five million doses have been used without serious adverse effects reported<sup>64</sup>. Pentrox™ has a maximum daily dose of 6mL/24hrs (that is, two “whistles”) which approximates 0.6 MAC-hours<sup>65</sup>. As nephrotoxicity has not been associated with 2.0 MAC hours or less<sup>65</sup>, this constitutes a significant safety margin. While it cannot be used for prolonged periods, it could potentially be used for short-durations, for example, as a bridging analgesic until epidural insertion. In a 2015 study, 56 women were given methoxyflurane (as Pentrox™) while having an epidural inserted<sup>66</sup>. Mean pain scores were significantly reduced following inhalations<sup>66</sup>. Further studies are required to assess the effects of Pentrox™ on the neonate, within current dosing limits.

#### Reduce nitrous oxide wastage

Nitrous oxide delivery systems with demand valves, that is, which only deliver gas during inspiration, ensure that the minimal fresh gas volume required is delivered. While these are commonly used in birthing suites, systems with continuous fresh gas flow (FGF) are utilised in other areas of the hospital including emergency and paediatric departments. When FGF exceeds minute ventilation, this results in considerable wasted/scavenged N<sub>2</sub>O. For example, our audit of this delivery system in Paediatric ED identified the average flow rate of N<sub>2</sub>O alone was 7 L/min (if 50 per cent N<sub>2</sub>O, a total of 14 L/min total FGF).

Nitrous oxide can also be wasted due to leaks from the cylinder manifolds, pipework and colour coded Schrader valves. Recent work by NHS Lothian in Scotland has shown that efficient monitoring and management of cylinder manifolds is crucial to detect waste from leaks and out of date cylinders<sup>6</sup>. Current legislation means that any residual N<sub>2</sub>O in cylinders when they are returned to the supply company must be vented, increasing wastage.

#### Waste capture and destruction technology

Nitrous oxide destruction systems have been successfully introduced in Sweden, where 84 per cent of climate impact from anaesthetic gases was due to N<sub>2</sub>O. This initiative has helped reduce the carbon footprint of their medical gases by half since 2009<sup>67</sup>. Exhaled N<sub>2</sub>O is collected via a facemask and undergoes catalytic splitting into N<sub>2</sub> and O<sub>2</sub>. Trials of similar technology have been conducted in the UK, with projections of a 75 per cent reduction in N<sub>2</sub>O emissions if it were to be expanded throughout the health service<sup>68</sup>. A single mobile destruction unit costs approximately \$A46,000 which is a considerable investment. For multiple delivery rooms, a central destruction unit is more efficient but requires significant infrastructure changes to include scavenging in delivery rooms.

## CONCLUSION

Nitrous oxide is used widely for the management of labour pain in Australia and New Zealand. While the medical literature acknowledges the lack of good quality evidence for its effectiveness, a common theme is that it is safe and convenient, and its use should therefore be continued. While it may be innocuous for the pregnant woman and unborn baby, that is certainly not the case for the environment.

ANZCA's statement on environmental sustainability illustrates that as anaesthetists we are “uniquely placed in that the choices we make at work can have an impact on our carbon footprint many times greater than

that of our other day-to-day activities<sup>27</sup>”. This sentiment is echoed by ASA<sup>25</sup>, ESA<sup>26</sup> and the Royal College of Anaesthetists statements on environmentally-responsible anaesthetic practice<sup>68</sup>. By educating medical staff and pregnant women about the carbon impact of N<sub>2</sub>O, ensuring that it is delivered and used as efficiently as possible and considering the use of more carbon-friendly alternatives, we can reduce GHG emissions from labour ward and help to mitigate the effects of climate change.

## REFERENCES

- Lew V, McKay E, Maze M. Past, present, and future of nitrous oxide. *Br Med Bull* [Internet]. 2018 Mar 1 [cited 2021 Feb 20]; 125(1):103-119. Available from: <https://pubmed.ncbi.nlm.nih.gov/29528367/>. doi: 10.1093/bmb/ldx050
- Leslie K, Myles PS, Kasza J, Forbes A, Peyton PJ, Chan MT, et al. Nitrous oxide and serious long-term morbidity and mortality in the evaluation of nitrous oxide in the gas mixture for anaesthesia (ENIGMA)-II trial. *Anesthesiology* [Internet]. 2015 Dec [cited 2021 Feb 21]; 123(6):1267-80. Available from: <https://pubmed.ncbi.nlm.nih.gov/26501387/>. doi: 10.1097/ALN.0000000000000908
- Eley VA, Callaway L, van Zundert AA. Developments in labour analgesia and their use in Australia. *Anaesth Intensive Care* [Internet]. 2015 Jul [cited 2021 Feb 20]; 43 Suppl:12-21. Available from: <https://pubmed.ncbi.nlm.nih.gov/26126071/>. doi: 10.1177/0310057X150430S104
- Australian Institute of Health and Welfare. Australia's mothers and babies 2018: in brief. [Internet]. Canberra: AIHW; 2020 [cited 2021 Feb 28]. 65 p. Available from: <https://www.aihw.gov.au/getmedia/aa54e74a-bda7-4497-93ce-e0010cb66231/aihw-per-108.pdf.aspx?inline=true>
- Bendall JC, Simpson PM, Middleton PM. Prehospital analgesia in New South Wales, Australia. *Prehosp Disaster Med* [Internet]. 2011 Dec [cited 2021 Apr 4]; 26(6):422-6. Available from: <https://pubmed.ncbi.nlm.nih.gov/22559307/>. doi: 10.1017/S1049023X12000180
- Chakera A, Fennel-Wells A, Allen C. Nitrous Oxide Mitigation: Launching the UK & ROI Audit. [Internet]. Centre for Sustainable Healthcare: Jan 2020 [cited 2021 Feb 22]. Available at: <https://www.youtube.com/watch?v=OreKYfF0d8s>
- McGain F, Bishop JR, Elliot-Jones LM, Story DA, Imberger GL. A survey of the choice of general anaesthetic agents in Australia and New Zealand. *Anaesth Intensive Care* [Internet]. 2019 May [cited 2021 Mar 9]; 47(3):235-241. Available from: <https://pubmed.ncbi.nlm.nih.gov/31088129/> doi: 10.1177/0310057X19836104
- Husum B, Stenqvist O, Alahuhta S, Sigurdsson GH, Dale O. Current use of nitrous oxide in public hospitals in Scandinavian countries. *Acta Anaesthesiol Scand* [Internet]. 2013 Oct [cited 2021 March 15]; 57(9):1131-7. Available from: <https://pubmed.ncbi.nlm.nih.gov/23889322/> doi: 10.1111/aas.12165.
- Likis FE, Andrews JC, Collins MR, Lewis RM, Seroogy JJ, Starr SA, et al. Nitrous oxide for the management of labor pain: a systematic review. *Anesth Analg* [Internet]. 2014 Jan [cited 2021 Feb 21]; 118(1):153-67. Available from: <https://pubmed.ncbi.nlm.nih.gov/24356165/>. doi: 10.1213/ANE.0b013e3182a7f73c
- Carstoniu J, Levitam S, Norman P, Daley D, Katz J, Sandler AN. Nitrous oxide in early labor. Safety and analgesic efficacy assessed by a double-blind, placebo-controlled study. *Anesthesiology* [Internet]. 1994 Jan [cited 2021 Feb 25]; 80(1):30-5. Available from: <https://pubmed.ncbi.nlm.nih.gov/8291726/>. doi: 10.1097/0000542-199401000-00008
- Klomp T, van Poppel M, Jones L, Lazet J, Di Nisio M, Lagro-Janssen AL. Inhaled analgesia for pain management in labour. *Cochrane Database Syst Rev*. [Internet]. 2012 Sep [cited 2021 Feb 22]; (9):CD009351. Available from: <https://pubmed.ncbi.nlm.nih.gov/22972140/>. doi: 10.1002/14651858.CD009351.pub2.
- Anim-Somuah M, Smyth RM, Cyna AM, Cuthbert A. Epidural versus non-epidural or no analgesia for pain management in labour. *Cochrane Database Syst Rev* [Internet]. 2018 May [cited 2021 Feb 22]; (5):CD000331. Available from: <https://pubmed.ncbi.nlm.nih.gov/29781504/>. doi: 10.1002/14651858.CD000331.pub4.
- Waldenström U. Experience of labor and birth in 1111 women. *J Psychosom Res* [Internet]. 1999 Nov [cited 2021 Feb 22]; 47(5):471-82. Available from: <https://pubmed.ncbi.nlm.nih.gov/10624845/>. doi: 10.1016/s0022-3999(99)00043-4
- Richardson MG, Lopez BM, Baysinger CL, Shotwell MS, Chestnut DH. Nitrous oxide during labor: Maternal satisfaction does not depend exclusively on analgesic effectiveness. *Anesth Analg* [Internet]. 2017 Feb [cited 2021 Feb 20]; 124(2):548-553. Available from: <https://pubmed.ncbi.nlm.nih.gov/28002168/>. doi: 10.1213/ANE.0000000000001680
- Jones PL, Rosen M, Mushin WW, Jones EV. Methoxyflurane and nitrous oxide as obstetric analgesics. II. A comparison by self-administered intermittent inhalation. *Br Med J* [Internet]. 1969 Aug [cited 2021 Feb 28]; 3(5665):259-262. Available from: <https://www.ncbi.nlm.nih.gov/pmc/articles/PMC1984080/>. doi:10.1136/bmj.3.5665.259
- Bergsjø P, Lindbæk E. Comparison Between Nitrous Oxide and Methoxyflurane for Obstetrical Analgesia. *Acta Obstetrica et Gynecologica Scandinavica* [Internet]. 1971 Jun. [cited 2021 Feb 28]; 50:3, 285-290. Available from: <https://www.tandfonline.com/doi/abs/10.3109/00016347109157325>. doi: 10.3109/00016347109157325
- Volmanen P, Akural E, Raudaskoski T, Ohtonen P, Alahuhta S. Comparison of remifentanyl and nitrous oxide in labour analgesia. *Acta Anaesthesiol Scand* [Internet]. 2005 Apr [cited 2021 Feb 22]; 49(4):453-8. Available from: <https://pubmed.ncbi.nlm.nih.gov/15777291/>. doi: 10.1111/j.1399-6576.2005.00639.x
- Messmer AA, Potts JM, Orlikowski CE. A prospective observational study of maternal oxygenation during remifentanyl patient-controlled analgesia use in labour. *Anaesthesia* [Internet]. 2016 Feb [cited 2021 Feb 28]; 71(2):171-6. Available from: <https://pubmed.ncbi.nlm.nih.gov/26617275/>. doi: 10.1111/anae.13329
- Marr R, Hyams J, Bythell V. Cardiac arrest in an obstetric patient using remifentanyl patient-controlled analgesia. *Anaesthesia* [Internet]. 2013 Mar [cited 2021 Mar 3]; 68(3):283-7. Available from: <https://pubmed.ncbi.nlm.nih.gov/23294158/>. doi: 10.1111/anae.12099
- Mobaraki N, Yousefian M, Seifi S, Sakaki M. A Randomized controlled trial comparing use of entonox with pethidine for pain relief in primigravid women during the active phase of labor. *Anesth Pain Med* [Internet]. 2016 Jul [cited 2021 Feb 22]; 6(4):e37420. Available from: <https://pubmed.ncbi.nlm.nih.gov/27843776/>. doi: 10.5812/aapm.37420

21. Broughton K, Clark AG, Ray AP. Nitrous oxide for labor analgesia: what we know to date. *Ochsner J* [Internet]. 2020 Winter [cited 2021 Feb 20]; 20(4):419-421. Available from: <https://pubmed.ncbi.nlm.nih.gov/33408580/>. doi: 10.31486/toj.19.0102
22. Bobb LE, Farber MK, McGovern C, Camann W. Does nitrous oxide labor analgesia influence the pattern of neuraxial analgesia usage? An impact study at an academic medical center. *J Clin Anesth* [Internet]. 2016 Dec [cited 2021 Mar 3]; 35:54-57. Available from: <https://pubmed.ncbi.nlm.nih.gov/27871590/>. doi: 10.1016/j.jclinane.2016.07.019
23. The Royal Australian and New Zealand College of Obstetricians and Gynaecologists. Pain relief in labour and childbirth [Internet]. RANZCOG; 2019 [cited 2021 Feb 28]. Available from: <https://ranzocg.edu.au/womens-health/patient-information-resources/pain-relief-in-labour-and-childbirth>
24. Yeoh CB, Lee KJ, Coric V, Tollinche LE. Simple green changes for anesthesia practices to make a difference. *EC Clin Med Case Rep* [Internet]. 2020 Dec [cited 2021 Feb 20]; 3(12):1-6. Available from: <https://pubmed.ncbi.nlm.nih.gov/33458720/>
25. Axelrod D, Bell C, Feldman J, Hopf H, Huncke TK, Paulsen W et al. Greening the operating room and perioperative arena: environmental sustainability for anesthesia practice. [Internet]. American Society of Anesthesiologists; 2014. [cited 2021 Feb 25]. Available from: <https://www.asahq.org/about-asa/governance-and-committees/asa-committees/committee-on-equipment-and-facilities/environmental-sustainability/greening-the-operating-room>
26. Albaladejo P, Beloel H, Brazzi L, Drenger B, Ferguson K, Jovanovic G et al. How to reduce our carbon footprint in the OR, in the hospital, on the planet? [Internet]. European Society of Anaesthesiology; [date unknown]. [cited 2021 Feb 25]. Available from: <https://www.esaic.org/uploads/2020/03/flash-display-screen1.pdf>
27. Australian and New Zealand College of Anaesthetists. PS64 Statement on environmental sustainability in anaesthesia and pain medicine practice. [Internet]. 2019 [cited 2021 Feb 25]. Available from: <https://www.anzca.edu.au/getattachment/570003dc-0a18-4837-b8c6-b9c3d2ed5396/PS64-Statement-on-environmental-sustainability-in-anaesthesia-and-pain-medicine-practice>
28. Stocker, T.F., D. Qin, G.-K. Plattner, M. Tignor, S.K. Allen, J. Boschung. IPCC (Intergovernmental Panel on Climate Change). The physical science basis. Contribution of working group I to the fifth assessment report of the intergovernmental panel on climate change. [Internet]. Cambridge: Cambridge University Press; 2013 [cited 2021 Feb 22]. 1535p. Available from: <https://www.ipcc.ch/report/ar5/wg1/>.
29. Sulbaek Andersen MP, Nielsen OJ, Karpichev B, Wallington TJ, Sander SP. Atmospheric chemistry of isoflurane, desflurane, and sevoflurane: kinetics and mechanisms of reactions with chlorine atoms and OH radicals and global warming potentials. *J Phys Chem A* [Internet]. 2012 Jun [cited 2021 Feb 20]; 116(24):5806-20. Available from: <https://pubmed.ncbi.nlm.nih.gov/22146013/>. doi: 10.1021/jp2077598
30. Ryan SM, Nielsen CJ. Global warming potential of inhaled anesthetics: application to clinical use. *Anesth Analg* [Internet]. 2010 Jul [cited 2021 Feb 21]; 111(1):92-8. Available from: <https://pubmed.ncbi.nlm.nih.gov/20519425/>. doi: 10.1213/ANE.0b013e3181e058d7.
31. McGain F. Why anaesthetists should no longer use nitrous oxide. *Anaesth Intensive Care* [Internet]. 2007 Oct [cited 2021 Mar 12]; 35(5):808-9. Available from: <https://pubmed.ncbi.nlm.nih.gov/17933180/>
32. WMO (World Meteorological Organization) Greenhouse Gas Bulletin. The state of greenhouse gases in the atmosphere based on global observations through 2019. [Internet]. Geneva: WMO; 2020 Nov [cited 2021 Feb 25]. 9p. Available from: [https://library.wmo.int/doc\\_num.php?explnum\\_id=10437](https://library.wmo.int/doc_num.php?explnum_id=10437)
33. McGain F, Muret J, Lawson C, Sherman JD. Environmental sustainability in anaesthesia and critical care. *Br J Anaesth* [Internet]. 2020 Nov [cited 2021 Feb 27]; 125(5):680-692. Available from: <https://pubmed.ncbi.nlm.nih.gov/32798068/>. doi:10.1016/j.bja.2020.06.055
34. Ishizawa Y. Special article: general anesthetic gases and the global environment. *Anesth Analg* [Internet]. 2011 Jan [cited 2021 Apr 26]; 112(1):213-7. Available from: <https://pubmed.ncbi.nlm.nih.gov/21048097/> doi: 10.1213/ANE.0b013e3181fe02c2
35. Malik A, Lenzen M, McAlister S, McGain F. The carbon footprint of Australian health care. *Lancet Planet Health* [Internet]. 2018 Jan [cited 2021 Feb 23]; 2(1):e27-e35. Available from: <https://pubmed.ncbi.nlm.nih.gov/29615206/>. doi: 10.1016/S2542-5196(17)30180-8
36. The United Nations Environment. Environmental rights and governance. Montreal protocol on substances that deplete the ozone layer. [Internet]. 1987 [cited 2021 Feb 21]. Available from: <https://www.unep.org/ozonaction/who-we-are/about-montreal-protocol>
37. Ravishankara A, Daniel JS, Portmann RW. Nitrous oxide (N2O): the dominant ozone-depleting substance emitted in the 21st century. *Science* [Internet]. 2009 Oct [cited 2021 Feb 21]; 326: 123e5. Available from: <https://pubmed.ncbi.nlm.nih.gov/19713491/>. doi: 10.1126/science.1176985
38. Abalos E, Oladapo OT, Chamillard M, Diaz V, Pasquale J, Bonet M et al. Duration of spontaneous labour in 'low-risk' women with 'normal' perinatal outcomes: A systematic review. *Eur J Obstet Gynecol Reprod Biol* [Internet]. 2018 April [cited 2021 March 28]; 223:123-132. Available from: <https://pubmed.ncbi.nlm.nih.gov/29518643/>. doi:10.1016/j.ejogrb.2018.02.026
39. Eliasson L, Phillips L, Stajduhar M, Carome M, Cowsar L. Oxygen consumption and ventilation during normal labor. *Chest* [Internet]. 1992 Aug [cited 2021 Mar 28]; 102(2):467-471. Available from: <https://pubmed.ncbi.nlm.nih.gov/1643934/> doi: 10.1378/chest.102.2.467
40. The Royal Hospital for Women. Local operating procedure – clinical. Morphine – subcutaneous (maternity) [Internet]. The Royal Hospital for Women; 2019 [cited 2021 Apr 4]. Available from: [https://www.seslhd.health.nsw.gov.au/sites/default/files/documents/morphsubmaternity19\\_0.pdf](https://www.seslhd.health.nsw.gov.au/sites/default/files/documents/morphsubmaternity19_0.pdf)
41. South Australian perinatal practice guideline. Analgesia for labour and birth (pharmacological) [Internet]. Department for health and wellbeing, government of South Australia; 2020 [cited 2021 Apr 4]. Available from: [https://www.sahealth.sa.gov.au/wps/wcm/connect/052c4527-f3dd-4a18-809d-9d948302cdc9/Analgesia+for+Labour+and+Birth+%28Pharmacological%29\\_PPG\\_v1\\_1.pdf?MOD=AJPERES&CACHEID=ROO\\_TWORKSPACE-052c4527-f3dd-4a18-809d-9d948302cdc9-nyxovcF](https://www.sahealth.sa.gov.au/wps/wcm/connect/052c4527-f3dd-4a18-809d-9d948302cdc9/Analgesia+for+Labour+and+Birth+%28Pharmacological%29_PPG_v1_1.pdf?MOD=AJPERES&CACHEID=ROO_TWORKSPACE-052c4527-f3dd-4a18-809d-9d948302cdc9-nyxovcF)

42. Auckland District Health Board. Remifentanyl patient controlled analgesia (PCA) for a woman in labour. [Internet]. Auckland DHB; 2019 Sep [cited 2021 Apr 4]. Available from: <https://nationalwomenshealth.adhb.govt.nz/assets/Womens-health/Documents/Policies-and-guidelines/Remifentanyl-Patient-Controlled-Analgesia-PCA-for-a-Woman-in-Labour.pdf>
43. West Suffolk National Health Service. Regional analgesia in labour. [Internet]. West Suffolk NHS; 2017 Sep [cited 2021 Apr 4]. Available from: [https://www.oaa-anaes.ac.uk/assets/\\_managed/cms/files/West%20Suffolk%20-%20RegionalAnalgesia,September2017.pdf](https://www.oaa-anaes.ac.uk/assets/_managed/cms/files/West%20Suffolk%20-%20RegionalAnalgesia,September2017.pdf)
44. The Royal Hospital for Women (RHW). Epidural analgesia guidelines for the RHW. [Internet]. RHW; 2016 Jun [cited 2021 Apr 4]. Available from: <https://www.seslhd.health.nsw.gov.au/sites/default/files/documents/epianalg16.pdf>
45. Parvatker A, Tunceroglu H, Sherman J, Coish P, Anastas P, Zimmerman J et al. Cradle-to-Gate greenhouse gas emissions for twenty anesthetic active pharmaceutical ingredients based on process scale-up and process design calculations. *ACS Sustainable Chem Eng* [Internet]. 2019 Jan [cited 2021 Mar 28]; 7(7):6580-6591. Available from: <https://pubs.acs.org/doi/10.1021/acssuschemeng.8b05473>. doi: 10.1021/acssuschemeng.8b05473
46. McAlister S, Ou Y, Neff E, Haggood K, Story D, Mealey P et al. The environmental footprint of morphine: a life cycle assessment from opium poppy farming to the packaged drug. *BMJ Open* [Internet]. 2016 Oct [cited 2021 Mar 28]; 6(10):e013302. Available from: <https://pubmed.ncbi.nlm.nih.gov/27798031/>. doi:10.1136/bmjopen-2016-013302
47. Usbharatana P, Phunggrassami H. Carbon footprints of rubber products supply chains (fresh latex to rubber glove). *Appl Ecol Environ Res* [Internet]. 2018 Jan [cited 2021 Mar 28]; 16: 1639-1657. Available from: [https://www.researchgate.net/publication/324533342\\_Carbon\\_footprints\\_of\\_rubber\\_products\\_supply\\_chains\\_Fresh\\_latex\\_to\\_rubber\\_glove](https://www.researchgate.net/publication/324533342_Carbon_footprints_of_rubber_products_supply_chains_Fresh_latex_to_rubber_glove). doi: 10.15666/aer/1602\_16391657
48. Vozzola E, Overcash M, Griffing E. Environmental considerations in the selection of isolation gowns: A life cycle assessment of reusable and disposable alternatives. *Am J Infect Control* [Internet]. 2018 Aug [cited 2021 Mar 28]; 46(8):881-886. Available from: <https://pubmed.ncbi.nlm.nih.gov/29655666/>. doi: 10.1016/j.ajic.2018.02.002.
49. Department for Business, Energy & Industrial Strategy. Greenhouse gas reporting: conversion factors 2020. [Internet]. UK Government; 2020 Jun [cited 2021 Feb 20]. Available from: <https://www.gov.uk/government/publications/greenhouse-gas-reporting-conversion-factors-2020>
50. Australian Government Department of Industry, Science, Energy and Resources. National Greenhouse Accounts Factors: 2020 [Internet]. Australian Government; 2020 Sep [cited 2021 Feb 25]. Available at: <https://www.industry.gov.au/data-and-publications/national-greenhouse-accounts-factors-2020>
51. Rizan C, Mahmood F, Bhutta M, Reed M, Lillywhite R. The carbon footprint of waste streams in a UK hospital. *J Clean Prod* [Internet]. 2021 Mar [cited 2021 Mar 10]; 286:125446. Available from: <https://www.sciencedirect.com/science/article/abs/pii/S0959652620354925>. doi: 10.1016/j.jclepro.2020.125446
52. Alexander R, Poznikoff A, Malherbe S. Greenhouse gases: the choice of volatile anesthetic does matter. *Can J Anaesth* [Internet]. 2018 Feb [cited 2021 Feb 20]; 65(2):221-222. Available from: <https://pubmed.ncbi.nlm.nih.gov/29119467/>. doi: 10.1007/s12630-017-1006-x
53. Clinical trials of different concentrations of oxygen and nitrous oxide for obstetric analgesia. Report to the Medical Research Council of the committee on nitrous oxide and oxygen analgesia in midwifery. *Br Med J* [Internet]. 1970 Mar [cited 2021 Feb 21]; 1(5698):709-13. Available from: <https://pubmed.ncbi.nlm.nih.gov/5440545/>
54. Westling F, Milsom I, Zetterström H, Ekström-Jodal B. Effects of nitrous oxide/oxygen inhalation on the maternal circulation during vaginal delivery. *Acta Anaesthesiol Scand* [Internet]. 1992 Feb [cited 2021 Feb 21]; 36(2):175-81. Available from: <https://pubmed.ncbi.nlm.nih.gov/1549939/>. doi: 10.1111/j.1399-6576.1992.tb03447.x
55. Hodnett ED. Pain and women's satisfaction with the experience of childbirth: a systematic review. *Am J Obstet Gynecol* [Internet]. 2002 May [cited 2021 Mar 10]; 186(5 Suppl Nature):S160-72. Available from: <https://pubmed.ncbi.nlm.nih.gov/12011880/> doi: 10.1067/mob.2002.121141
56. Jones L, Othman M, Dowswell T, Alfirevic Z, Gates S, Newburn M et al. Pain management for women in labour: an overview of systematic reviews. *Cochrane Database Syst Rev* [Internet]. 2012 Mar [cited 2021 Feb 25]; 2012(3):CD009234. Available from: <https://pubmed.ncbi.nlm.nih.gov/22419342/>. doi: 10.1002/14651858.CD009234.pub2.
57. Richardson MG, Raymond BL, Baysinger CL, Kook BT, Chestnut DH. A qualitative analysis of parturients' experiences using nitrous oxide for labor analgesia: It is not just about pain relief. *Birth* [Internet]. 2019 Mar [cited 2021 Feb 28]; 46(1):97-104. Available from: <https://pubmed.ncbi.nlm.nih.gov/30033596/>. doi: 10.1111/birt.12374
58. Smith CA, Collins CT, Levett KM, Armour M, Dahlen HG, Tan AL, Mesgarpour B. Acupuncture or acupressure for pain management during labour. *Cochrane Database Syst Rev* [Internet]. 2020 Feb [cited 2021 Mar 3]; 2(2):CD009232. Available from: <https://pubmed.ncbi.nlm.nih.gov/32032444/>. doi: 10.1002/14651858.CD009232.pub2
59. Smith CA, Levett KM, Collins CT, Dahlen HG, Ee CC, Sukanuma M. Massage, reflexology and other manual methods for pain management in labour. *Cochrane Database Syst Rev* [Internet]. 2018 Mar [cited 2021 Mar 3]; 3(3):CD009290. Available from: <https://pubmed.ncbi.nlm.nih.gov/29589380/>. doi: 10.1002/14651858.CD009290.pub3
60. Chia YT, Arulkumaran S, Chua S, Ratnam SS. Effectiveness of transcutaneous electric nerve stimulator for pain relief in labour. *Asia Oceania J Obstet Gynaecol* [Internet]. 1990 Jun [cited 2021 Apr 15]; 16(2):145-51. Available from: <https://pubmed.ncbi.nlm.nih.gov/2378593/>. doi: 10.1111/j.1447-0756.1990.tb00017.x
61. Rashtchi V, Maryami N, Molaei B. Comparison of entonox and transcutaneous electrical nerve stimulation (TENS) in labor pain: a randomized clinical trial study. *J Matern Fetal Neonatal Med*. [Internet]. 2020 Aug [cited 2021 Apr 15]: 1-5. Available from: <https://pubmed.ncbi.nlm.nih.gov/32862743/>. doi: 10.1080/14767058.2020.1813706
62. Sultan P, Murphy C, Halpern S, Carvalho B. The effect of low concentrations versus high concentrations of local anesthetics for labour analgesia on obstetric and anesthetic outcomes: a meta-analysis. *Can J Anaesth* [Internet]. 2013 Sep [cited 2021 Mar 10]; 60(9):840-54. Available from: <https://pubmed.ncbi.nlm.nih.gov/23925722/>. doi: 10.1007/s12630-013-9981-z
63. Hass S, Andersen M, Nielsen O. Atmospheric chemistry of methoxyflurane (CH3OCF2CHCl2): products and mechanisms. *Chem Phys Lett* [Internet]. 2020 Feb [cited 2021 Mar 20]; 740: 137052. Available from: <https://www.sciencedirect.com/science/article/abs/pii/S0009261419310334>. doi: 10.1016/j.cplett.2019.137052.

64. Jephcott C, Grummet J, Nguyen N, Spruyt O. A review of the safety and efficacy of inhaled methoxyflurane as an analgesic for outpatient procedures. *Br J Anaesth* [Internet]. 2018 May [cited 2021 Mar 20]; 120(5):1040-1048. Available from: <https://pubmed.ncbi.nlm.nih.gov/29661381/>. doi: 10.1016/j.bja.2018.01.011
65. Dayan AD. Analgesic use of inhaled methoxyflurane: Evaluation of its potential nephrotoxicity. *Hum Exp Toxicol* [Internet]. 2016 Jan [cited 2021 Apr 4]; 35(1):91-100. Available from: <https://pubmed.ncbi.nlm.nih.gov/25926525/>. doi: 10.1177/0960327115578743
66. Anwari JS, Khalil L, Terkawi AS. Efficacy of the methoxyflurane as bridging analgesia during epidural placement in laboring parturient. *Saudi J Anaesth* [Internet]. 2015 Oct [cited 2021 Mar 20]; 9(4):370-375. Available from: <https://pubmed.ncbi.nlm.nih.gov/26543451/>. doi:10.4103/1658-354X.159457
67. Nordic Centre for Sustainable Healthcare (NCSH). Best practices of sustainable healthcare in the Nordics. [Internet]. NCSH: 2020 [cited 2021 Mar 26]. Available from: [https://nordicshc.org/images/Nordic\\_know-how\\_2020\\_Nitrous\\_Oxide\\_2.pdf](https://nordicshc.org/images/Nordic_know-how_2020_Nitrous_Oxide_2.pdf)
68. National Health Service (NHS). Delivering a net zero national health service. [Internet]. NHS: 2020 Oct [cited 2021 Mar 26]. Available from: <https://www.england.nhs.uk/greenernhs/wp-content/uploads/sites/51/2020/10/delivering-a-net-zero-national-health-service.pdf>

## Epidural labour analgesia: Current trends, advances, and future techniques

### Victor Chen MBBS (Hons.), DiplIBarts, MMed (CritCare)

Anaesthetics Registrar, Mater Hospital, Queensland

Dr Victor Chen is an anaesthesia registrar in Brisbane with an interest in obstetric anaesthesia and pain medicine.

### Harriet Wood MBBS FRCA FANZCA

Consultant Anaesthetist, Redland Hospital, Queensland

Dr Harriet Wood moved to Australia in 2016 after 10 years as an anaesthetic consultant in the UK. Harriet is acute pain lead at Redland and maintains a strong interest in education and service development.

## INTRODUCTION

It is more than 80 years since epidurals were introduced to provide analgesia in labour. They remain the gold standard of available options for labour analgesia and are the most common neuraxial intervention in childbirth in Australia today. Multiple studies have demonstrated decreased pain scores and increased maternal satisfaction when compared to alternatives such as intravenous opioids<sup>1,2</sup>. This review evaluates the current evidence for the epidural drugs and delivery systems used during labour with a focus on low concentration anaesthetic solutions. Epidural for caesarean section is outside the scope of this review.

The latest Australian Institute of Health and Welfare (AIHW) statistics show an increase in demand for epidural labour analgesia over the past decade with rates increasing from 28.2% to 36.6%<sup>2,3</sup>. However, there is a significant regional variation of epidural rates across states and territories with the lowest in the Australian Capital Territory (26.7%) and the highest in Western Australia (45.1%). Overall, in 2018 there were 84,592 epidurals placed in Australia. Rates of epidurals in labour are variable in different countries ranging from 19 to 83% in nulliparous women and 10 to 64% in multiparous women<sup>4</sup>.

## EPIDURAL DRUG CHOICE

The amide local anaesthetics bupivacaine, ropivacaine and lidocaine (lignocaine) constitute the most common medications used in infusions of local anaesthetics through the epidural catheter in labour. Bupivacaine was discovered in 1957<sup>5</sup> and has the highest rate of cardiac toxicity and the lowest plasma concentration required for toxicity of the amide local anaesthetics. Subsequent pharmacological advances gave rise to ropivacaine and also levobupivacaine, as the pure S-enantiomer of bupivacaine<sup>6</sup>.

Ropivacaine has been thought to have approximately 60% of the analgesic potency and 66% of the motor blockade potency when compared with bupivacaine<sup>7,8</sup>; however, this has been challenged by a more recent study<sup>9</sup> and remains somewhat controversial. Meta-analysis has shown that the analgesic, neonatal and obstetric outcomes for ropivacaine and bupivacaine are similar. In 19 of these 23 studies, motor block was more frequent in the bupivacaine group but the concentrations of local anaesthetic and infusion techniques varied such that the analysis could not ascribe any increased motor block being a result of the inherent properties of the drug<sup>10</sup>. A direct comparative study of ropivacaine with fentanyl and bupivacaine with fentanyl, each at 0.1% of local anaesthetic, found that ropivacaine caused reduced motor blockade<sup>11</sup>.

Lidocaine with adrenaline has been commonly used as a test dose to detect accidental intrathecal or intravascular catheter insertion due to its rapid onset and haemodynamic effects. This technique however is becoming less popular due to the risk of motor blockade or total spinal anaesthesia<sup>12,13</sup>. Furthermore, there is less risk of systemic local anaesthetic toxicity from intravascular catheter insertion with low concentration local anaesthetic preparations<sup>14</sup>. Lidocaine is less suitable for ongoing epidural infusion when compared to longer acting alternatives with inferior quality of analgesia when compared to bupivacaine<sup>15</sup> requiring more frequent bolus dosing, in part due to a shorter duration of action, and shorter time to two-segment regression<sup>16</sup>.

Levobupivacaine was first approved by the Therapeutics and Goods Administration for the Australian market in 2001<sup>17</sup>. As an isolated S-enantiomer of bupivacaine it has decreased cardiotoxicity when compared to racemic bupivacaine<sup>6</sup>. The comparison of efficacy between levobupivacaine to other amide local anaesthetics in epidurals has yielded mixed results. Levobupivacaine has been found to have similar levels of labour analgesia and motor blockade when compared with equal concentration 0.125% racemic bupivacaine and higher concentration 0.2% ropivacaine<sup>18,19</sup>. The reported minimum local analgesic concentration was similar with both levobupivacaine and racemic bupivacaine<sup>20</sup>. In contrast, a study of the epidural analgesic potency of levobupivacaine using up-down sequential dose allocation found efficacy to be similar to ropivacaine with a potency ratio of 1.02<sup>21</sup>.

Low concentration opioids, such as fentanyl, have been added to local anaesthetic preparations due to their ability to reduce total local anaesthetic consumption. There is an inverse relationship between the concentration of fentanyl and motor blockade<sup>22</sup>. This reduction in local anaesthetic consumption has also allowed for the successful usage of low concentration local anaesthetic preparations in labour epidural analgesia, which consequently reduces motor blockade<sup>22</sup>. Fentanyl has the additional advantage of increasing the speed of onset of the initial dose<sup>23</sup>.

Dexamethasone shows some promise for use in epidural infusions, prolonging bolus duration without significant adverse effects<sup>24,25,26</sup>. The intravenous route has also provided improvement in pain from dexamethasone<sup>27</sup> and the mechanism of action, ideal dose, and route are not yet clear.

## LOCAL ANAESTHETIC CONCENTRATION

Historically, lidocaine 1.5-2% with adrenaline was used for ongoing epidural maintenance. A decade after the introduction of bupivacaine, it was used for ongoing epidural analgesia at concentrations between 0.25-0.5%<sup>28</sup>. There has been a movement towards the utilisation of lower concentration local anaesthetics for ongoing analgesia to avoid some of the common side effects such as motor blockade and urinary retention. Concentrations such as 0.1% ropivacaine and 0.0625% bupivacaine, each with 2 mcg/ml fentanyl, are increasingly being adopted for epidural labour analgesia.

The Comparative Obstetric Mobile Epidural Trial (COMET) study demonstrated that lower dose 0.1% bupivacaine with 2 mcg/mL fentanyl when compared with 0.25% bupivacaine resulted in improved foetal outcomes and also decreased instrumental delivery while providing similar levels of analgesia<sup>29,30</sup>. There was also decreased motor blockade and decreased loss of ability to spontaneously urinate<sup>31</sup>. Interestingly there was no statistically significant difference in total mass of local anaesthetic consumption between 0.1% bupivacaine with fentanyl and 0.25% bupivacaine.

Meta-analysis of similar trials<sup>32</sup> has supported the COMET findings when comparing high concentration local anaesthetics of between 0.175-0.2% ropivacaine and 0.125-0.25% bupivacaine to low concentration anaesthetics of between 0.0625-0.1% bupivacaine and 0.1% ropivacaine. The majority of studies included in the meta-analysis used combined local anaesthetic and opioid techniques although the opioid component was kept constant. This meta-analysis found multiple positives for low concentration local anaesthetics including a decreased rate of assisted deliveries, decreased duration of second stage of labour, decreased motor blockade and decreased urinary retention. Analgesia provided was similar with no difference in maternal pain score. A decreased total local anaesthetic mass was required with the low concentration local anaesthetic in this meta-analysis, deviating from that found in the COMET study.

There are limited studies available detailing the advantages or disadvantages of “ultra-low” concentration local anaesthetics in labour epidurals with conflicting evidence available. A study of 40 patients comparing 0.05% ropivacaine with 0.05% bupivacaine demonstrated that both concentrations could be used effectively for labour analgesia<sup>33</sup>. Similarly, a study of 0.075% ropivacaine with 2 mcg/mL fentanyl provided comparable and satisfactory analgesia when compared with 0.075% bupivacaine with 2 mcg/mL fentanyl<sup>34</sup>. A study of 60 patients conducted by Singh, et al<sup>35</sup> comparing 0.05% ropivacaine, 0.1% ropivacaine and 0.2% ropivacaine with 2 mcg/mL fentanyl added to the preparation, found that the 0.05% ropivacaine with fentanyl preparation resulted in decreased quality of analgesia.

Studies for non-labour epidurals have demonstrated that concentrations lower than those described in the included meta-analysis studies by Sultan, et al can be effective in post-operative analgesia. A study of 30 patients undergoing abdominal surgery conducted by Liu, et al. found that analgesia was similar with less motor blockade when comparing 0.2% ropivacaine with 4 mcg/mL fentanyl, 0.1% ropivacaine with 2 mcg/mL fentanyl and 0.05% ropivacaine with 1 mcg/mL fentanyl<sup>36</sup>. Furthermore, a small study of post-caesarean section patients suggested that a 0.025% ropivacaine with 3 mcg/mL fentanyl and 0.5 ug/mL adrenaline could provide comparable analgesia to 0.2% ropivacaine while preserving urinary function and ambulation<sup>37</sup>.

There is surprisingly little information available to choose one initial bolus dose over another, but the benefits of low concentration agents remain. In the volumes 5 to 20mL, the volume and concentration has been found to not be a significant factor for onset<sup>38</sup>. A dose response study for epidural ropivacaine, published in *Anesthesiology* in 2001<sup>39</sup> found an ED50 of 18.4mg and extrapolated an ED95 of 55.9mg ropivacaine for successful initiation. However, their “success” was based on a 50% reduction of pain within 30 minutes, which most would consider slow and insufficient pain relief for a clinically satisfactory epidural. The study found that a ropivacaine dose of 30mg produced a 50% reduction in pain within half an hour in 80% of patients. Fentanyl or other low dose opiate within the loading dose speeds onset and improves quality of the block, as previously described, and should be included in the first dose.

Other studies have found an initial dose of between 22mg and 36mg ropivacaine to be effective<sup>7,40,41</sup>. Further studies are required to determine the ideal volume, concentration, drug mass and speed of bolus of the initial loading dose. A double-blind prospective study found no benefit to giving the initial dose via the Tuohy needle rather than the epidural catheter<sup>42</sup>.

## DRUG DELIVERY SYSTEMS AND REGIMEN

The method of epidural drug delivery has changed significantly over time with techniques ranging from physician or midwife boluses, continuous epidural infusion (CEI), mandatory intermittent boluses (MIB) given manually, or programmed intermittent boluses (PIB) via a pump, and patient-controlled epidural analgesia (PCEA). PCEA is preferred by patients when compared to alternatives such as continuous epidural infusion<sup>43</sup>. PCEA benefits include a decrease in motor blockade and decreased total local anaesthetic consumption. PCEA also reduces anaesthetic workload by significantly decreasing the requirement for clinician boluses while delivering similar analgesia, patient satisfaction and obstetric outcomes<sup>44</sup>. PCEA is most frequently used in combination with either PIB or CEI.

Programmed intermittent boluses consist of delivery of a defined amount of local anaesthetic via a pump after a defined period of time; benefits compared to continuous epidural infusion include superior analgesia. It is theorised that a larger bolus under pressure spreads better throughout the epidural space compared to a slow continuous infusion. In porcine models, an intermittent bolus of 1 mL over 1 second resulted in spread over 15.2 cm of the epidural space as opposed to a continual infusion of 1 mL over 30 minutes which resulted in spread over 8.9 cm<sup>45</sup>. Although the porcine model was chosen due to similarities with human neuraxial anatomy, there hasn't been significant differences in height of the block when comparing CEI and PIB in human randomised controlled trials<sup>46,47</sup>.

Intermittent bolus techniques result in decreased breakthrough pain and a corresponding trend towards improved maternal satisfaction<sup>48</sup>. A decrease of local anaesthetic required, by approximately 1.7 mg/hour of bupivacaine equivalents, is seen in patients with PCEA plus intermittent bolus as opposed to PCEA plus CEI<sup>49</sup>. There is also a trend towards a reduction in both the second stage of labour and total time of labour, however there was significant variation between studies<sup>49</sup>. There is an associated decrease in instrumental deliveries in nulliparous women with intermittent bolus techniques with no difference in caesarean section rate<sup>49,50</sup>. Caesarean section rates are unchanged for women with either type of epidural, compared to those without.

There have been other potential benefits of intermittent boluses demonstrated in trials. Wong, et al found that there was an increase in time to first PCEA usage with mandatory intermittent boluses which is suggestive of superior analgesia<sup>51</sup>. Capogna, et al compared PIB to CEI with low local anaesthetic concentrations, looking specifically at motor blockade as the primary outcome. They found a significant reduction in motor blockade with only 2.7% of the PIB group having motor blockade as opposed to 37% in the CEI group<sup>52</sup>. Bullingham, et al<sup>53</sup> found that only 1% of patients had motor blockade with PIB plus PCEA when compared to 21.8% in the CEI group. The study however compared a stronger concentration of local anaesthetic in the CEI group with a lesser concentration in the PIB group. This was also reflected by the greatly reduced local anaesthetic dosage requirement of 7.8 mg/hr ropivacaine in the PIB plus PCEA group compared to 13.8 mg/hr in the CEI group. There have been some dissenting trials where no difference in motor blockade with intermittent bolus techniques was found; however, these findings were not associated with a decrease in local anaesthetic consumption<sup>54,55</sup>. A recent meta-analysis supports an overall trend towards decreased motor blockade nevertheless this was not statistically significant<sup>56</sup>.

There has been work to delineate the best time gap between boluses and the optimal volume for a given bolus. Most intermittent bolus regimens used in randomised controlled trials have included low concentration local anaesthetic with intermittent boluses of between 5 to 10 mL every hour, although there were studies that used lower bolus volumes and more frequent boluses<sup>50</sup>. The optimal bolus volume has been investigated, with a biased coin up-and-down sequential allocation study using 0.0625% bupivacaine with fentanyl 2mcg/mL. A volume of 11 mL or higher every 40 minutes was found to be superior to lower volumes<sup>57</sup>. Bolus interval investigation demonstrates that if a mandatory intermittent bolus of 10 mL of low concentration local anaesthetic is given, a 40-minute lockout reduces PCEA usage requirements compared to longer timeframes<sup>58</sup>.

Intermittent bolus techniques when compared with continuous infusions may provide workflow related benefit. There is a statistically significant reduction in breakthrough pain with intermittent bolus techniques<sup>50</sup> which could reduce both anaesthetic intervention and review. A recent meta-analysis suggests that there is a statistically significant reduction in anaesthetic interventions with intermittent bolus techniques with an odds ratio of 0.71<sup>49</sup>. This reduction in ongoing resource utilisation has implications from a health economics perspective as both the provision and maintenance of labour epidurals is labour intensive. Improvements in patient comfort and a decrease in breakthrough pain may also reduce midwifery workload however this is an area which would require further investigation.

## ULTRASOUND GUIDANCE/DIFFICULT ACCESS

Successful access and threading of the catheter into the epidural space has traditionally been via palpation of anatomical landmarks and a loss of resistance technique. A Cochrane meta-analysis published in 2014 concluded that with the generally low-quality evidence available, there is no demonstrable, statistically significant, difference between saline and air, either in effectiveness or with regard to safety<sup>59</sup>. However, due to concerns previously raised about the risk of injecting air into the CSF, saline is currently the suggested technique for epidural localisation. Identification of the level of insertion has traditionally been via the Iliac crests and intercrystal line transecting through the level of the L4 spinous process or L4/L5 intervertebral space<sup>60</sup>. Anaesthetists may only be able to accurately palpate a defined interspace in as few as 29% of cases<sup>61</sup>. The midline is usually determined by palpation of the spinous processes although paramedian approaches can be used as an alternative<sup>62</sup>.

Predictors of difficult epidural access include depth to space, body mass index and quality of anatomical landmarks<sup>63,64</sup>. With the increasing prevalence of obesity among Western countries ultrasonography is a potential useful adjunct for successful identification of the epidural space. The two main approaches utilising ultrasonography include pre-procedural scanning and real time scanning. Pre-procedural scanning allows for accurate identification of the midline, the intervertebral space level and also the angulation required to reach the epidural space. A 2016 meta-analysis<sup>65</sup> found that ultrasound provided an accurate estimate of depth to space within 3 mm and also had a statistically significant decrease in number of needle passes required and traumatic insertions. A 2013 meta-analysis<sup>66</sup> found that ultrasound guidance reduced the incidence of failed epidurals. The benefits of enhanced success may be offset by the additional time taken in straightforward cases.

In real time ultrasound scanning both single and dual operator techniques have been described<sup>67,68</sup>. The single operator technique uses a spring-loaded loss of resistance syringe, allowing for one hand to hold the epidural needle and the other to hold the ultrasound probe. Although an attractive idea, there are some difficulties related to both techniques. The single operator technique was studied predominantly on normal BMI patients with a median BMI of 22.8<sup>67</sup>. Furthermore, these were performed in an elective situation with no comment on time to epidural access. Dual operator techniques can also run into issues with workflow and workforce management of anaesthetic staffing.

There has been ongoing improvement in ultrasound technology with improvements to both probe technology and image processing to deliver improved visualisation of anatomical structures<sup>69</sup>. Improvement in visualisation of deeper anatomical structures is of increasing importance; there are several new possibilities on the horizon. The advent of smaller ultrasound transmitters allows for both ultrasound-in-needle techniques and also needle-through-ultrasound techniques. The ultrasound through needle technique relies on a 0.7 mm ultrasound transmitter which fits through a 18G Tuohy needle. This allowed for visualisation of both ligamentum flavum and also the dura mater in porcine models<sup>70</sup>. A needle through ultrasound technique has also been performed on human models. Using “A-mode”, this technique relies on changes in acoustic impedance to locate the intervertebral space<sup>71</sup>. Neither of these techniques have been adopted into routine clinical practice and any benefit is yet to be established.

## NEW DEVELOPMENTS AND FUTURE ADVANCES

Complications from epidurals have altered little over recent times. There have been ongoing developments regarding management and insertion of epidural catheters for labour over the last decade. With an eye towards the future, there are several more advances on the horizon.

### Epidural technique

An evolution on the existing epidural technique is the dural puncture epidural (DPE) which involves puncturing into the intrathecal space with a spinal needle prior to threading of the epidural catheter. It differs at this point from the established combined spinal epidural technique in that no medication is delivered directly into the intrathecal space. It is thought that by puncturing the dura and arachnoid layers, this allows for minor spread of the epidural medication into the subarachnoid space. There have been contradictory findings regarding the benefit of the DPE technique when compared to a traditional approach. Some studies have found that there is an improved onset of analgesia<sup>72</sup> whereas other studies have not despite similar study designs<sup>73</sup>. Other proposed benefits include a decrease in unilateral block and also a decrease in anaesthetist interventions. There was a statistically significant decrease in anaesthetist top-up<sup>73</sup> and a non-statistically significant decrease in epidural replacement/manipulation<sup>72</sup>. The potential workload and workflow benefits could be an area which would be worth further exploring.

The clinical implications of any difference in onset of analgesia are also questionable as the median onset of analgesia with DPE was found to be eight minutes as opposed to the traditional epidural taking 10 minutes<sup>74</sup>.

There was no statistically significant difference in likelihood of achieving satisfactory analgesia at 10 minutes and no difference in maternal satisfaction or motor blockade. The lack of difference in patient satisfaction has also been echoed in a study utilising a 25G spinal needle DPE technique<sup>75</sup>. Lastly, there is potentially superior sacral nerve blockade with a DPE when compared to traditional epidural techniques, however this was only manifested in techniques using 25G needles<sup>72,73</sup> with more variable effects with narrower gauge spinal needles<sup>76,77</sup>.

### Epidural equipment

Identification of the epidural space has been traditionally based on the qualitative loss of resistance technique due to the negative pressure nature of the potential space, whether using saline, air or the mainly historical “hanging drop” technique. Quantitative measurement via a pressure transducer is an emerging technology that allows for objective identification of any change in pressure. This confirms entry into the epidural space with location of a sustained pressure drop<sup>78</sup>. Quantitative pressure monitoring can be displayed visually or with sound and is an area of ongoing investigation and research.

Near-infrared tracking has also been explored briefly in cadavers for identification of the catheter tip. A near-infrared light wire is passed within an epidural catheter through the Tuohy needle during epidural insertion. This light can be seen with an infrared sensor and viewed on screen. This provides the benefit of avoiding x-ray radiation which would be associated with alternative methods of identification such as fluoroscopy. The technology is not currently suitable for clinical usage due to poor visualisation in the obese patient and when the catheter enters paramedian or paravertebral locations<sup>79</sup>. With further advances, this may be a method of interest in troubleshooting an ineffective epidural, but it remains in its infancy.

Spring-loaded epidural loss of resistance syringes are another innovation. The spring-loaded syringe allows for application of constant pressure to a column of saline similar to that applied by the anaesthetist using conventional methods. It also allows for the freeing up of a hand, thus permitting a two-handed technique when advancing the epidural needle. Initial studies have suggested that adoption of this method may result in improved ability to find the epidural space<sup>80</sup>. The caveat however in this study is that it was performed at a teaching institution with less experienced practitioners. For more experienced practitioners, there was no difference in identification of the epidural space along with a small statistically significant but not clinically significant reduction by five seconds in time to thread the epidural catheter<sup>81</sup>.

There has also been the advent of other loss of resistance syringes which allow for two-handed advancement of the epidural needle. There is potential for decreased time taken for identification of the epidural space and subjective improved control of the epidural needle however this is an area which would benefit from further study including characterisation of any improvement in the quality of analgesia or maternal satisfaction with the new equipment<sup>82,83</sup>. One of the limiting factors for intermittent bolus techniques has historically been the availability of suitable equipment. The initial studies of intermittent boluses with PCEA were in part originally delivered via two separate pumps for PCEA and intermittent boluses<sup>52</sup>. The availability of pumps capable of both PCEA and intermittent bolus delivery will aid uptake of this method.

There has been exploration into the use of computer-integrated control of epidural dosing. This technique relied on integration of maternal PCEA usage into the calculation of an appropriate background CEI rate<sup>84</sup>. This is an area where further advances in artificial intelligence and data analysis may be of significant benefit. Pattern recognition of patient behaviour who have increasing pain may result in early identification and hence early prevention of breakthrough pain. Future technology may see increased nuance added to computer algorithms with consideration of not only recent doses, but also of labour progress, the pattern of local anaesthetic spread as manifested by dermatomal and motor blockade, and lastly the pattern of patient PCEA usage.

### Augmented reality and machine learning

Augmented reality has been beneficial in education and training in other medical specialties, such as general surgery<sup>85</sup>. There are benefits of computer-aided simulation with improved fidelity that could be applied to training for epidural catheter insertion. Virtual reality allows for simulated epidural insertion along with real time feedback to a trainee regarding time taken, speed through layers, number of re-angulations and also any dural punctures<sup>86</sup>. This could range from improvements in anatomical learning to needle tracking and also identification of an appropriate intervertebral level for access. There may be value in the implementation and development of augmented reality for cases of difficult neuraxial access. Ashab and colleagues described a technique where augmented reality aided in the identification of intervertebral level along with projection of the levels onto the patients back<sup>87</sup>. This technique, while similar to ultrasound pre-scanning, provides ongoing feedback of the location of each intervertebral level.

The use of artificial intelligence to automate the identification of spinal anatomy to allow effective epidural and spinal placement is already available and in clinical use. The UK National Institute for Clinical Excellence (NICE) reviewed four trials using the currently available device, Accuro, in 2021<sup>88</sup>; these trials included women in labour and obese patients. The studies showed an increase in procedural time and an epidural depth finding of +/0.6cm



compared with standard ultrasound techniques<sup>89,90</sup>. NICE concluded from this limited evidence that there may be benefit to the device in obese patients, however, further studies were needed to confirm this. Accuro is already being used clinically in Australia and further data on its efficacy is required. Although there is an associated learning curve with the adoption of any new technique, a trend towards improvement in first attempt success and a reduction in number of attempts when compared to a palpatory technique after six usages of the Accuro system by trainee anaesthetists<sup>91</sup>. Other automated identification of spinal anatomical landmarks techniques, such as uSINE, are currently under development, however full results are yet to be published<sup>92</sup>.

Lastly, ongoing advances in equipment safety and standards are of paramount importance. The ongoing implementation of neural/neuraxial devices with connectors compliant to the new international standard ISO80369-6 has been endorsed by ANZCA. In Australia, standard syringes are used for both intra-vascular injection, intrathecal and epidural injection. ISO80369-6 is aimed at preventing accidental epidural/intrathecal injection by limiting interconnectivity of syringe types<sup>93</sup>. As an international standard, it has already seen partial adoption across other healthcare systems, such as in the United Kingdom<sup>94</sup>. This process has been slowed in part due to interruptions to supply chains and re-prioritisation of healthcare priorities over the past year.

## CONCLUSION

There is good evidence to support a movement towards the usage of low concentration local anaesthetics and also intermittent bolus techniques. There are new and exciting developments on the horizon with further advances in both epidural technique, equipment and medication which will decrease patient morbidity and hopefully improve maternal satisfaction and safety.

## REFERENCES

- Anim-Somuah M, Smyth RM, Cyna AM, Cuthbert A. Epidural versus non-epidural or no analgesia for pain management in labour. *Cochrane Database Syst Rev*. 2018; 5:CD000331.
- Australian Institute of Health and Welfare. Data tables: Australia's Mothers and babies 2018 – in brief supplementary tables. [Internet]. Canberra (ACT). Australian Institute of Health and Welfare. 2020. Available from: <https://www.aihw.gov.au/reports/mothers-babies/australias-mothers-and-babies-2018-in-brief/data>
- Laws P, Sullivan EA. Australia's mothers and babies 2007. Perinatal statistics. Sydney (NSW): Australian Institute of Health and Welfare; 2009 December. p 115. Cat. no. PER 48
- Seijmonsbergen-Schermer AE, van den Akker T, Rydahl E, Beeckman K, Bogaerts A, Binfa L, et al. Variations in use of childbirth interventions in 13 high-income countries: A multinational cross-sectional study. *PLoS Med*. 2020; 17(5):e1003103.
- Ruetsch YA, Boni T, Borgeat A. From cocaine to ropivacaine: The history of local anesthetic drugs. *Curr Top Med Chem*. 2001; 1(3):175-82.
- Shafer SL, Rathmell JP, Flood P. Stoelting's pharmacology and physiology in anesthetic practice. Fifth edition. ed. Philadelphia: Wolters Kluwer Health; 2015.
- Polley LS, Columb MO, Naughton NN, Wagner DS, van de Ven CJ. Relative analgesic potencies of ropivacaine and bupivacaine for epidural analgesia in labor: Implications for therapeutic indexes. *Anesthesiology*. 1999; 90(4):944-50.
- Lacassie HJ, Columb MO, Lacassie HP, Lantadilla RA. The relative motor blocking potencies of epidural bupivacaine and ropivacaine in labor. *Anesth Analg*. 2002; 95(1):204-8.
- Kaur A, Singh RB, Tripathi RK, Choubey S. Comparison between bupivacaine and ropivacaine in patients undergoing forearm surgeries under axillary brachial plexus block: A prospective randomized study. *J Clin Diagn Res*. 2015; 9(1):UC01-6.
- Halpern SH, Walsh V. Epidural ropivacaine versus bupivacaine for labor: A meta-analysis. *Anesth Analg*. 2003; 96(5):1473-9.
- Guo S, Li B, Gao C, Tian Y. Epidural analgesia with bupivacaine and fentanyl versus ropivacaine and fentanyl for pain relief in labor: A meta-analysis. *Medicine (Baltimore)*. 2015; 94(23):e880.
- Richardson MG, Lee AC, Wissler RN. High spinal anesthesia after epidural test dose administration in five obstetric patients. *Reg Anesth*. 1996; 21(2):119-23.
- Cohen SE, Yeh JY, Riley ET, Vogel TM. Walking with labor epidural analgesia: The impact of bupivacaine concentration and a lidocaine-epinephrine test dose. *Anesthesiology*. 2000; 92(2):387-92.
- Massoth C, Wenk M. Epidural test dose in obstetric patients: Should we still use it? *Curr Opin Anaesthesiol*. 2019; 32(3):263-7.
- Milaszkiwicz R, Payne N, Loughnan B, Blackett A, Barber N, Carli F. Continuous extradural infusion of lignocaine 0.75% vs bupivacaine 0.125% in primiparae: Quality of analgesia and influence on labour. *Anaesthesia*. 1992; 47(12):1042-6.
- Seow LT, Lips FJ, Cousins MJ, Mather LE. Lidocaine and bupivacaine mixtures for epidural blockade. *Anesthesiology*. 1982; 56(3):177-83.
- Tattersall M. ADEC 214th meeting resolutions. [Internet] Canberra (ACT): Therapeutic Goods Administration; 2001 Feb 26. Available from: <https://www.tga.gov.au/committee-meeting-info/dec-214th-meeting-resolutions-8-9-february-2001>
- Camorcio M, Capogna G. Epidural levobupivacaine, ropivacaine and bupivacaine in combination with sufentanil in early labour: A randomized trial. *Eur J Anaesthesiol*. 2003; 20(8):636-9.
- Sah N, Vallejo M, Phelps A, Finegold H, Mandell G, Ramanathan S. Efficacy of ropivacaine, bupivacaine, and levobupivacaine for labor epidural analgesia. *J Clin Anesth*. 2007; 19(3):214-7.
- Lyons G, Columb M, Wilson RC, Johnson RV. Epidural pain relief in labour: Potencies of levobupivacaine and racemic bupivacaine. *Br J Anaesth*. 1998; 81(6):899-901.
- Polley LS, Columb MO, Naughton NN, Wagner DS, van de Ven CJ, Goralski KH. Relative analgesic potencies of levobupivacaine and ropivacaine for epidural analgesia in labor. *Anesthesiology*. 2003; 99(6):1354-8.
- Li Y, Hu C, Fan Y, Wang H, Xu H. Epidural analgesia with amide local anesthetics, bupivacaine, and ropivacaine in combination with fentanyl for labor pain relief: A meta-analysis. *Med Sci Monit*. 2015; 21:921-8.
- Vedagiri Sai R, Singh SI, Qasem F, Nguyen D, Dhir S, Marmai K, et al. Onset of labour epidural analgesia with low-dose bupivacaine and different doses of fentanyl. *Anaesthesia*. 2017; 72(11):1371-8.
- Ali HM, Wahdan A. Using dexamethasone as an adjuvant to levobupivacaine in epidural anesthesia to change the pain intensity and duration in painless labor. *Saudi J Anaesth*. 2018; 12(2):209-14.
- Wahdan AS, El-Sakka AI, Hassan AR, Mohamed MM, Gaafar HMI, Helmy NY. Epidural levobupivacaine versus a combination of levobupivacaine and dexamethasone in patients receiving epidural analgesia. *J Anaesthesiol Clin Pharmacol*. 2019; 35(1):109-13.
- Dhal A, Mitra S, Saroa R, Singh J, Mehra R. Can epidural dexamethasone reduce patient-controlled epidural consumption of fentanyl and levobupivacaine in laboring women? A double-blind, randomized, placebo-controlled trial. *J Obstet Gynaecol India*. 2019; 69(3):258-65.
- Dube P, Mitra S, Singh J, Saroa R, Mehra R. Intravenous dexamethasone as an adjunct to improve labor analgesia: A randomized, double-blinded, placebo controlled clinical trial. *J Clin Anesth*. 2017; 43:6-10.
- Duthie AM, Wyman JB, Lewis GA. Bupivacaine in labour. *Anaesthesia*. 1968; 23(1):20-6.
- Comparative Obstetric Mobile Epidural Trial Study Group UK. Effect of low-dose mobile versus traditional epidural techniques on mode of delivery: A randomised controlled trial. *Lancet*. 2001; 358(9275):19-23.
- Wilson MJ, Cooper G, MacArthur C, Shennan A, Comparative Obstetric Mobile Epidural Trial Study Group UK. Randomized controlled trial comparing traditional with two "mobile" epidural techniques: Anesthetic and analgesic efficacy. *Anesthesiology*. 2002; 97(6):1567-75.
- Wilson MJ, MacArthur C, Shennan A, Group CS. Urinary catheterization in labour with high-dose vs mobile epidural analgesia: A randomized controlled trial. *Br J Anaesth*. 2009; 102(1):97-103.
- Sultan P, Murphy C, Halpern S, Carvalho B. The effect of low concentrations versus high concentrations of local anesthetics for labour analgesia on obstetric and anesthetic outcomes: A meta-analysis. *Can J Anaesth*. 2013; 60(9):840-54.
- Pirbudak L, Tuncer S, Kocoglu H, Goksu S, Celik C. Fentanyl added to bupivacaine 0.05% or ropivacaine 0.05% in patient-controlled epidural analgesia in labour. *Eur J Anaesthesiol*. 2002; 19(4):271-5.
- Owen MD, Thomas JA, Smith T, Harris LC, D'Angelo R. Ropivacaine 0.075% and bupivacaine 0.075% with fentanyl 2 microg/ml are equivalent for labor epidural analgesia. *Anesth Analg*. 2002; 94(1):179-83, table of contents.
- Singh K, Khandelwal H, Agarwal S, Singh A, Bhattacharyya P. Comparison of three different concentrations of epidural ropivacaine (0.05%, 0.1% & 0.2%) for labor analgesia: A prospective randomized and double blind study. *Indian Journal of Clinical Anaesthesia*. 2018; 5:403-6.
- Liu SS, Moore JM, Luo AM, Trautman WJ, Carpenter RL. Comparison of three solutions of ropivacaine/fentanyl for postoperative patient-controlled epidural analgesia. *Anesthesiology*. 1999; 90(3):727-33.
- Cohen S, Chhokra R, Stein MH, Denny JT, Shah S, Mohiuddin A, et al. Ropivacaine 0.025% mixed with fentanyl 3.0 mug/ml and epinephrine 0.5 mug/ml is effective for epidural patient-controlled analgesia after cesarean section. *J Anaesthesiol Clin Pharmacol*. 2015; 31(4):471-7.
- Lee BB, Ngan Kee WD, Wong EL, Liu JY. Dose-response study of epidural ropivacaine for labor analgesia. *Anesthesiology*. 2001; 94(5):767-72.
- Chan L, Lee BB, Ngan Kee WD. A randomised double-blinded controlled trial of the effect of diluent volume on the efficacy of a single dose of epidural ropivacaine for labour analgesia. *Int J Obstet Anesth*. 2006; 15(3):201-5.
- Beilin Y, Galea M, Zahn J, Bodian CA. Epidural ropivacaine for the initiation of labor epidural analgesia: A dose finding study. *Anesth Analg*. 1999; 88(6):1340-5.
- Capogna G, Celleno D, Fusco P, Lyons G, Columb M. Relative potencies of bupivacaine and ropivacaine for analgesia in labour. *Br J Anaesth*. 1999; 82(3):371-3.
- Risteve G, Sipes AC, Mahoney B, Lipps J, Chan G, Coffman JC. Initiation of labor analgesia with injection of local anesthetic through the epidural needle compared to the catheter. *J Pain Res*. 2017; 10:2789-96.
- Gambling DR, Yu P, Cole C, McMorland GH, Palmer L. A comparative study of patient controlled epidural analgesia (pcea) and continuous infusion epidural analgesia (ciea) during labour. *Can J Anaesth*. 1988; 35(3 Pt 1):249-54.
- van der Vyver M, Halpern S, Joseph G. Patient-controlled epidural analgesia versus continuous infusion for labour analgesia: A meta-analysis. *Br J Anaesth*. 2002; 89(3):459-65.
- Mowat I, Tang R, Vaghadia H, Krebs C, Henderson WR, Sawka A. Epidural distribution of dye administered via an epidural catheter in a porcine model. *Br J Anaesth*. 2016; 116(2):277-81.
- Lange EMS, Wong CA, Fitzgerald PC, Davila WF, Rao S, McCarthy RJ, et al. Effect of epidural infusion bolus delivery rate on the duration of labor analgesia: A randomized clinical trial. *Anesthesiology*. 2018; 128(4):745-53.
- Fidkowski CW, Shah S, Alsaden MR. Programmed intermittent epidural bolus as compared to continuous epidural infusion for the maintenance of labor analgesia: A prospective randomized single-blinded controlled trial. *Korean J Anesthesiol*. 2019; 72(5):472-8.
- Sng BL, Zeng Y, de Souza NNA, Leong WL, Oh TT, Siddiqui FJ, et al. Automated mandatory bolus versus basal infusion for maintenance of epidural analgesia in labour. *Cochrane Database Syst Rev*. 2018; 5:CD011344.
- Tzeng IS, Kao MC, Pan PT, Chen CT, Lin HY, Hsieh PC, et al. A meta-analysis of comparing intermittent epidural boluses and continuous epidural infusion for labor analgesia. *Int J Environ Res Public Health*. 2020; 17(19).

50. Xu J, Zhou J, Xiao H, Pan S, Liu J, Shang Y, et al. A systematic review and meta-analysis comparing programmed intermittent bolus and continuous infusion as the background infusion for parturient-controlled epidural analgesia. *Sci Rep*. 2019; 9(1):2583.
51. Wong CA, Ratliff JT, Sullivan JT, Scavone BM, Toledo P, McCarthy RJ. A randomized comparison of programmed intermittent epidural bolus with continuous epidural infusion for labor analgesia. *Anesth Analg*. 2006; 102(3):904-9.
52. Capogna G, Camorcia M, Stirparo S, Farcomeni A. Programmed intermittent epidural bolus versus continuous epidural infusion for labor analgesia: The effects on maternal motor function and labor outcome. A randomized double-blind study in nulliparous women. *Anesth Analg*. 2011; 113(4):826-31.
53. Bullingham A, Liang S, Edmonds E, Mathur S, Sharma S. Continuous epidural infusion vs programmed intermittent epidural bolus for labour analgesia: A prospective, controlled, before-and-after cohort study of labour outcomes. *Br J Anaesth*. 2018; 121(2):432-7.
54. Fidkowski CW, Shah S, Alsaden MR. Programmed intermittent epidural bolus as compared to continuous epidural infusion for the maintenance of labor analgesia: A prospective randomized single-blinded controlled trial. *Korean J Anesthesiol*. 2019; 72(5):472-8.
55. Fettes PDW, Moore CS, Whiteside JB, Mcleod GA, Wildsmith JAW. Intermittent vs continuous administration of epidural ropivacaine with fentanyl for analgesia during labour. *BJA: British Journal of Anaesthesia*. 2006; 97(3):359-64.
56. Liu X, Zhang H, Zhang H, Guo M, Gao Y, Du C. Intermittent epidural bolus versus continuous epidural infusions for labor analgesia: A meta-analysis of randomized controlled trials. *PLoS One*. 2020; 15(6):e0234353.
57. Zakus P, Arzola C, Bittencourt R, Downey K, Ye XY, Carvalho JC. Determination of the optimal programmed intermittent epidural bolus volume of bupivacaine 0.0625% with fentanyl 2 mug.Ml(-1) at a fixed interval of forty minutes: A biased coin up-and-down sequential allocation trial. *Anaesthesia*. 2018; 73(4):459-65.
58. Epszstein Kanczuk M, Barrett NM, Arzola C, Downey K, Ye XY, Carvalho JC. Programmed intermittent epidural bolus for labor analgesia during first stage of labor: A biased-coin up-and-down sequential allocation trial to determine the optimum interval time between boluses of a fixed volume of 10 ml of bupivacaine 0.0625% with fentanyl 2 mug/ml. *Anesth Analg*. 2017; 124(2):537-41.
59. Antibas PL, do Nascimento Junior P, Braz LG, Vitor Pereira Doles J, Modolo NS, El Dib R. Air versus saline in the loss of resistance technique for identification of the epidural space. *Cochrane Database Syst Rev*. 2014; (7):CD008938.
60. Kim SH, Kim DY, Han JI, Baik HJ, Park HS, Lee GY, et al. Vertebral level of tuffier's line measured by ultrasonography in parturients in the lateral decubitus position. *Korean J Anesthesiol*. 2014; 67(3):181-5.
61. Broadbent CR, Maxwell WB, Ferrie R, Wilson DJ, Gawne-Cain M, Russell R. Ability of anaesthetists to identify a marked lumbar interspace. *Anaesthesia*. 2000; 55(11):1122-6.
62. Jaucot J. Paramedian approach of the peridural space in obstetrics. *Acta Anaesthesiol Belg*. 1986; 37(3):187-92.
63. Kim JH, Song SY, Kim BJ. Predicting the difficulty in performing a neuraxial blockade. *Korean J Anesthesiol*. 2011; 61(5):377-81.
64. Uyl N, de Jonge E, Uyl-de Groot C, van der Marel C, Duvekot J. Difficult epidural placement in obese and non-obese pregnant women: A systematic review and meta-analysis. *Int J Obstet Anesth*. 2019; 40:52-61.
65. Perlas A, Chaparro LE, Chin KJ. Lumbar neuraxial ultrasound for spinal and epidural anesthesia: A systematic review and meta-analysis. *Reg Anesth Pain Med*. 2016; 41(2):251-60.
66. Shaikh F, Brzezinski J, Alexander S, Arzola C, Carvalho JC, Beyene J, et al. Ultrasound imaging for lumbar punctures and epidural catheterisations: Systematic review and meta-analysis. *BMJ*. 2013; 346:f1720.
67. Karmakar MK, Li X, Ho AM, Kwok WH, Chui PT. Real-time ultrasound-guided paramedian epidural access: Evaluation of a novel in-plane technique. *Br J Anaesth*. 2009; 102(6):845-54.
68. Grau T, Leipold RW, Fatehi S, Martin E, Motsch J. Real-time ultrasonic observation of combined spinal-epidural anaesthesia. *Eur J Anaesthesiol*. 2004; 21(1):25-31.
69. Henderson M, Dolan J. Challenges, solutions, and advances in ultrasound-guided regional anaesthesia. *BJA Education*. 2016; 16(11):374-80.
70. Chiang HK, Zhou Q, Mandell MS, Tsou MY, Lin SP, Shung KK, et al. Eyes in the needle: Novel epidural needle with embedded high-frequency ultrasound transducer--epidural access in porcine model. *Anesthesiology*. 2011; 114(6):1320-4.
71. Chen GS, Chang YC, Chang Y, Cheng JS. A prototype axial ultrasound needle guide to reduce epidural bone contact. *Anaesthesia*. 2014; 69(7):746-51.
72. Cappiello E, O'Rourke N, Segal S, Tsen LC. A randomized trial of dural puncture epidural technique compared with the standard epidural technique for labor analgesia. *Anesth Analg*. 2008; 107(5):1646-51.
73. Chau A, Bibbo C, Huang CC, Elterman KG, Cappiello EC, Robinson JN, et al. Dural puncture epidural technique improves labor analgesia quality with fewer side effects compared with epidural and combined spinal epidural techniques: A randomized clinical trial. *Anesth Analg*. 2017; 124(2):560-9.
74. Wilson SH, Wolf BJ, Bingham K, Scotland QS, Fox JM, Woltz EM, et al. Labor analgesia onset with dural puncture epidural versus traditional epidural using a 26-gauge whitacre needle and 0.125% bupivacaine bolus: A randomized clinical trial. *Anesth Analg*. 2018; 126(2):545-51.
75. Gupta D, Srirajakalidindi A, Soskin V. Dural puncture epidural analgesia is not superior to continuous labor epidural analgesia. *Middle East J Anaesthesiol*. 2013; 22(3):309-16.
76. Thomas JA, Pan PH, Harris LC, Owen MD, D'Angelo R. Dural puncture with a 27-gauge whitacre needle as part of a combined spinal-epidural technique does not improve labor epidural catheter function. *Anesthesiology*. 2005; 103(5):1046-51.
77. Yadav P, Kumari I, Narang A, Baser N, Bedi V, Dindor BK. Comparison of dural epidural technique versus conventional epidural technique for labor analgesia in primigravida. *J Obstet Anaesth Crit Care*. 2018; 8(1):24-28.
78. Ghelber O, Gebhard RE, Vora S, Hagberg CA, Szmuk P. Identification of the epidural space using pressure measurement with the compuflo injection pump--a pilot study. *Reg Anesth Pain Med*. 2008; 33(4):346-52.

79. Chiu SC, Bristow SJ, Gofeld M. Near-infrared tracking system for epidural catheter placement: A feasibility study. *Reg Anesth Pain Med*. 2012; 37(3):354-6.
80. Habib AS, George RB, Allen TK, Olufolabi AJ. A pilot study to compare the episure autodetect syringe with the glass syringe for identification of the epidural space in parturients. *Anesth Analg*. 2008; 106(2):541-3, table of contents.
81. Carabuena JM, Mitani AM, Liu X, Kodali BS, Tsen LC. The learning curve associated with the epidural technique using the episure autodetect versus conventional glass syringe: An open-label, randomized, controlled, crossover trial of experienced anesthesiologists in obstetric patients. *Anesth Analg*. 2013; 116(1):145-54.
82. Sawada A, Kii N, Yoshikawa Y, Yamakage M. Epidrum((r)): A new device to identify the epidural space with an epidural tuohy needle. *J Anesth*. 2012; 26(2):292-5.
83. Kartal S, Kosem B, Kilinc H, Kosker H, Karabayirli S, Cimen NK, et al. Comparison of epidrum, epi-jet, and loss of resistance syringe techniques for identifying the epidural space in obstetric patients. *Niger J Clin Pract*. 2017; 20(8):992-7.
84. Sia AT, Lim Y, Ocampo CE. Computer-integrated patient-controlled epidural analgesia: A preliminary study on a novel approach of providing pain relief in labour. *Singapore Med J*. 2006; 47(11):951-6.
85. Tang KS, Cheng DL, Mi E, Greenberg PB. Augmented reality in medical education: A systematic review. *Can Med Educ J*. 2020; 11(1):e81-e96.
86. Vaughan N, Dubey VN, Wee MYK, Isaacs R. Virtual reality simulation based assessment objectives for epidural training1. *Journal of Medical Devices*. 2014; 8(2).
87. Al-Deen Ashab H, Lessoway VA, Khallaghi S, Cheng A, Rohling R, Abolmaesumi P. An augmented reality system for epidural anesthesia (area): Prepuncture identification of vertebrae. *IEEE Trans Biomed Eng*. 2013; 60(9):2636-44.
88. Charlton J, Werpachowska E, Chinyandura M, Porter M, Farquhar-Thomson D. Accuro for guiding epidural or spinal anaesthesia. [Internet]. London (UK): National Institute for Health and Care Excellence; 2021 Jan 26. p 11. Available from: <https://www.nice.org.uk/advice/mib245/resources/accuro-for-guiding-epidural-or-spinal-anaesthesia-pdf-2285965634626501>
89. Capogna G, Baglioni S, Milazzo V, Vitale A. Accuracy of the SpineNav3DTM technology to measure the depth of epidural space: A comparison with the standard ultrasound technique in pregnant volunteers. *Open J Anesthesiol* [Internet]. 2018 Apr; 8(4):113-22. Available from: <https://www.scirp.org/journal/paperinformation.aspx?paperid=83867>. DOI: 10.4236/ojanes.2018.84012
90. Seligman KM, Weiniger CF, Carvalho B. The accuracy of a handheld ultrasound device for neuraxial depth and landmark assessment: A prospective cohort trial. *Anesth Analg*. 2018; 126(6):1995-8.
91. Singla P, Dixon AJ, Sheeran JL, Scalzo D, Mauldin FW, Jr., Tiouririne M. Feasibility of spinal anesthesia placement using automated interpretation of lumbar ultrasound images: A prospective randomized controlled trial. *J Anesth Clin Res*. 2019; 10(2).
92. KK Women's and Children's Hospital. An Ultrasound Guided Automated Spinal Landmark Identification System (uSINE). [Internet] Washington (DC): U.S. National Library of Medicine; 6 February 2021. Available from: <https://clinicaltrials.gov/ct2/show/NCT03687411>
93. Australian Commission on Safety and Quality in Healthcare. Joint statement on neuraxial connectors and ISO 80369-6:2016. [Internet]. Sydney (NSW); Australian Commission on Safety and Quality in Healthcare; 2017 Mar. Available from: <https://www.safetyandquality.gov.au/sites/default/files/migrated/ANZCA-and-Commission-position-statement-on-neuraxial-connectors-2017Mar.pdf>
94. National Health Service. Resources to support safe transition from the Luer connector to NRFitTM for intrathecal and epidural procedures, and delivery of regional blocks: National Health Service. London (UK); 2017 Aug. Available from: [https://improvement.nhs.uk/documents/1550/Patient\\_Safety\\_Alert\\_-\\_resources\\_to\\_support\\_transition\\_to\\_NRFit\\_Aug\\_2017v2.pdf](https://improvement.nhs.uk/documents/1550/Patient_Safety_Alert_-_resources_to_support_transition_to_NRFit_Aug_2017v2.pdf)

## Labour epidural injustice

**Ian Maddox, BSc, MBChB, MBioeth, FANZCA**

**Specialist anaesthetist, departments of anaesthesia, pain and perioperative medicine, King Edward Memorial Hospital for Women, and Fiona Stanley Hospital, Western Australia**

Dr Ian Maddox graduated from the Universities of St Andrews and Manchester in 1999, before moving to Australia in 2004 where he undertook anaesthesia training. He has interests in obstetric anaesthesia, bioethics, and the history of medicine.

### INTRODUCTION

Despite the enthusiasm for other modes of analgesia in labour, it is generally accepted that epidural analgesia provides the most consistently effective pain relief during childbirth<sup>1</sup>. However, practical ethical issues abound around its provision. These extend beyond the commonly experienced disquiet of the anaesthetist regarding informed consent (as the mother urges them to just get the bloody epidural in, ignoring the operator's desire to provide full disclosure of risk and benefits). We face questions within three of the four pillars of medical ethics – those of autonomy, non-maleficence, and beneficence. Midwives hold it within their discretion to decide when, if at all, to act on a mother's request for epidural analgesia by calling an anaesthetist. Similarly, the anaesthetist has the power to prioritise other duties, or their own needs, over promptly attending the distressed woman. Additionally, resources may be limited such that, with the best of intentions, neither midwife nor anaesthetist can always promise timely epidural analgesia. These are real issues as revealed by a 2020 UK government inquiry, which, although reported by several media outlets, was never made public<sup>2</sup>. While in Australia and New Zealand midwives and anaesthetists generally provide an excellent labour analgesia service, we can expect, and my experience in Australia confirms, that similar issues to those in the UK exist. Here we must consider the fourth pillar of medical ethics, often neglected in considerations of labour analgesia: justice.

In this article I shall examine how the labouring women requesting epidural analgesia can be the subject of injustice, and how we as anaesthetists may contribute to that injustice. I shall argue that society unwarrantedly regards the acute severe pain of childbirth differently from other situations of acute severe pain. The result is a subtle, sometimes subconscious, and unjust deprioritising of labour epidural analgesia.

### HISTORICAL AND MODERN VIEWS ON LABOUR ANALGESIA

On 7 April 1853, Queen Victoria, para seven and 33 years old, inhaled chloroform by open drop method for the 53 minutes of her second stage of labour under the watchful eye of Dr John Snow. Snow described the process in his handwritten notes: "Her Majesty expressed great relief from the application, the pains being trifling during the uterine contractions, and whilst between the periods of contraction there was complete ease. The effect of the chloroform was not at any time carried to the extent of quite removing consciousness<sup>3(p31,32)</sup>".

Victoria herself described it as, "...that blessed chloroform, soothing, quieting and delightful beyond measure<sup>4(p116)</sup>".

Controversy around pharmacological relief of pain in labour began as soon as the technique was practised. Following Queen Victoria's 1853 delivery, *The Lancet* declared, in opposition to the Queen's praise of the drug, "In no case could it be justifiable to administer chloroform in a perfectly ordinary labour...<sup>5</sup>". They may have had some valid concern regarding the safety of chloroform, and we are indeed lucky that John Snow's reputation was not shattered by an iatrogenic royal death – lucky because the Queen's experience may have gone some way towards greater acceptance of analgesia in labour, and lucky because it was in the following year that John Snow's famous work in tracing the London cholera outbreak paved the way for great advances in public health<sup>6</sup>.

The arguments against providing pain relief centred around safety, the physiological benefit of pain, and the diagnostic and procedural benefits of pain (for example, in assisting correct placement of forceps)<sup>7</sup>.

Although widely described, religious objections based on Genesis 3:16 ("I will greatly multiply your pain in childbirth; In pain you will bring forth children") do not in fact seem to have formed a significant part of the objection to analgesia in childbirth<sup>7</sup>. James Simpson published in 1847 a pamphlet entitled *Answer to the Religious Objections Advanced Against the Employment of Anaesthetic Agents in Midwifery and Surgery*, in which he presented theological more than humane arguments to counter the religious objections<sup>8</sup>. However, this may have been a pre-emptive action rather than a response to a widespread and serious body of opinion<sup>7</sup>.

It will surprise no one that some doctors expressed overt sexism in their objection to chloroform in labour. A Dr Sheppard wrote in 1853, "No female for whom I have any regard shall ever, with my consent, inhale chloroform. I look upon its exhibition as a pandering to the weakness of humanity, especially the weaker sex."

Religious objections need not be dignified with any rational argument. Objections grounded in historically misogynistic attitudes similarly can be ignored (although I fear, but will not address here, that more subtle sexism still plays a part in attitudes today). Nevertheless, explicit and paternalistic denial of a woman's request for labour epidural analgesia, based upon both claims of safety and the benefit of pain to the mother and child, still persist today. These claims are not sufficient, I argue, to justify that paternalism.

## MODERN EXPLICIT OBJECTIONS TO LABOUR EPIDURAL ANALGESIA

“Labour analgesia diminishes childbirth as a rite of passage and undermines the mother's bond with her child.”

This is how a journalist in 2009 described the views of midwifery professor Dennis Walsh as set out in his paper published that year<sup>10</sup>. In his manuscript, Walsh discusses the rise in labour epidural use, and argues, with a very long bow, that it is an unwelcome sign of problems in “inadequate service provision and an impoverished approach to labour pain”. He pejoratively refers to the rise as an “epidemic”. At the time of publication, it produced a storm of media controversy. I mention it here as a prominent example of an explicit defence of the denial of labour epidural analgesia. Walsh goes further than the summary statement of the journalist (the first part of which is a value judgement, the second part unevidenced) arguing that his assertion, along with exaggerated and non-causative claims of other harms, carries enough weight to justify challenging the autonomy of the labouring woman. Indeed, Walsh sees respect for autonomy as a barrier to his conception of a good labour. As a factor contributing to the undesirable (in his view) “epidural epidemic” he cites, “Informed choice as an ethical imperative [influencing] practitioners' responses to maternal requests for pain relief in labour.” In an interview reported in the same *Guardian* piece, he is quoted as saying that maternity staff are “too quick to offer an epidural or agree to a woman in labour's request for a pain-killing injection in her back to ease her suffering<sup>9</sup>.” Walsh is advocating denial of relief of severe pain despite a competent woman's request. Perhaps, if there was uncontroversial evidence of significant harm of the type he ascribes to epidurals, such paternalism could be justified. Even then it would take very strong arguments to override a woman's informed decision. Value judgements around “rites of passage”, and teleological conjecture regarding pain in labour fall well short.

If the autonomy of the labouring woman requesting an epidural is to be actively overridden, and epidural analgesia denied, perhaps it is on the claim that competence is lost in the throes of labour. The severe pain of childbirth has been cited as a factor both diminishing and enhancing competence<sup>11</sup>. On the one hand, it is argued, the severe pain of labour inhibits the mother's ability to process the information presented as risks and benefits, and thus competence is questioned in the presence of such pain. On the other hand, simultaneous claims are made that only in experiencing labour, with the accompanying severe pain, can the true benefit of an epidural be weighed against its risks. That up to half of all primigravidae who choose to have an epidural did not originally intend to have one can support either position<sup>11</sup>. Supporting the first position, capacity is lost, and a woman makes a decision contrary to her previous decision made when she was competent. Supporting the second position, only when the benefit of an epidural can be clearly realised – when experiencing the pain – is the woman fully informed. Discussing labour epidural analgesia in the calm, unhurried setting of the antenatal clinic, whilst clearly recommended, does not provide the mother with *all* the information needed to make an informed choice. Much work has been done in this area, and, like Walsh's arguments for paternalism, we need extremely strong evidence to conclude that labour can affect capacity to the point where we can justifiably override maternal autonomy.

Such evidence may come from studying later psychological effects of receiving, declining, or withholding labour epidural analgesia. Research is of course fraught: multiple confounders and subtle causal mechanisms are likely missed, and randomised controlled trials difficult to conduct robustly and ethically. While one study found that receiving epidural analgesia when the intention had been to go without is an associative factor in developing post-natal depression<sup>12</sup>, others have found epidural analgesia protective against post-natal depression<sup>13-15</sup>. Other studies were equivocal<sup>16,17</sup>. A large study assessing maternal satisfaction at 24- and 48-hours post-partum found that pain intensity during either the first or second stage of labour, and a delay of more than 15 minutes for attendance of an anaesthetist after request were strongly associated with dissatisfaction<sup>18</sup>. At present, evidence of later psychological effects of withholding or providing labour epidural analgesia lacks quantity and quality sufficient to excuse paternalistic denial of labour epidural analgesia.

Within these empirical arguments for and against the provision of labour epidural analgesia, autonomy is implicitly or explicitly sidelined. To question the assumption of autonomy requires very good arguments, which I deny Walsh and others have, especially when what they propose to deny is something as intrinsically worthwhile as the relief of acute severe pain.

The principle of respect for autonomy underlies provision of epidural analgesia. While many women autonomously decline the treatment, paternalistic withholding of analgesia can rarely be defended. Very occasionally, for example in extreme circumstances such as a severe coagulopathy, the principle of non-

maleficence might justify denial of labour epidural analgesia. The normal risks and complications of a labour epidural are not reason enough to deny it to the competent woman. Beyond challenging epidural denial through paternalism, we must challenge its denial through injustice.

To confront these objections and cultural expectations directed against an autonomous mother's wish for effective analgesia, and for society to make decisions regarding distribution of health dollars, we must first argue for the moral value of the relief of pain itself.

## THE INTRINSIC VALUE OF THE RELIEF OF ACUTE SEVERE PAIN

A defence of the intrinsic moral value of the relief of severe pain will, as with any claim of intrinsic value, be subject to John Stuart Mill's assertion that, “Questions of ultimate ends are not amenable to direct proof<sup>19(677)</sup>”. That is, when we supply a chain of argument to defend a moral position, eventually we arrive at a point where we believe there is good for its own sake – in this case the relief of severe pain. Further discussion of such metaethics is beyond the scope of this article, but I think it reasonable to continue upon the premise that relief of pain *per se* does not require further downstream benefits to justify its worth.

Illustrating this view that the relief of pain has intrinsic value, popular articles listing the greatest innovations in medicine invariably include anaesthesia<sup>20</sup>. Although the experience of pain must be subjective, that experience is universal (aside from extremely rare conditions of insensibility to pain), and we have at least some ability to imagine pain that is worse than that to which we have been previously exposed. Severe pain is feared, and oblivion to that pain in the form of anaesthesia desired. This is reflected in the prominent position anaesthesia holds in those tables of medical innovation – most people believe relief from severe pain is of great importance. While being careful to avoid an appeal to democracy, human interest in avoiding pain is almost self-evident enough to forego any further discussion. What is important to discuss, however, is how we divide resources amongst treatments for different causes of acute severe pain, as well as other claims upon our health dollars and anaesthetists' time. In making such decisions we must consider the value we place upon the relief of the pain of childbirth.

## HOW THE PAIN OF CHILDBIRTH IS TREATED DIFFERENTLY FROM OTHER CAUSES OF ACUTE SEVERE PAIN

In addition to the explicit and argued objections to epidural analgesia, I suggest that the acute severe pain of childbirth is implicitly regarded differently from other causes of acute severe pain. This is evident in the behaviour of midwives and anaesthetists, institutional policies, and societal expectation, as I shall demonstrate below. The result is a deprioritising of labour epidural analgesia manifested in, occasionally, outright denial of analgesia, and, more commonly, a tolerance of delays and under-resourcing.

What follows is anecdotal, but anecdotes that most anaesthetists and midwives will recognise:

- Requests for epidurals for two different mothers come through on the duty anaesthetist pager in quick succession. The duty anaesthetist can attend one, but asks a registrar in a theatre doubled up with a consultant to attend the other. The consultant says the registrar will be down to the labour ward in 30 minutes after completing their in-theatre tutorial on G-proteins; that will be within the audit-acceptable timeframe.
- The consultant anaesthetist on-call refuses to come into hospital at night to site an epidural in a labouring woman in pain, because the registrar will be able to attend within the hour, when their theatre case has finished. The consultant claims that coming in will, through fatigue, adversely affect their morning list.
- A man requiring an incision and drainage of a perianal abscess is given general anaesthesia. Were anaesthesia not provided, the acute severe pain of the surgery would be transient. The physiological stress response to such surgery is not significant enough that anaesthesia provides any benefit other than oblivion to the acute incision.
- A woman has a Colles fracture reduced in the emergency department. For the reduction, analgesia is provided in the form of a Bier's block, and conscious sedation with midazolam. Again, if analgesia were not provided, the escalation of the pain would be transient during the reduction.
- Sedation is routinely provided for gastroscopy and colonoscopy. Often in Australia this is provided by an anaesthetist.

In each of these examples we see how the acute severe pain of childbirth can be treated differently from acute severe pain due to other causes. Would any anaesthetist delay attending their endoscopy list to complete a

tutorial, telling the gastroenterologist to continue with the procedure without sedation until we arrive? Similarly, would we delay providing analgesia to reduce the Colles fracture, or incise the abscess, telling the surgeon to carry on until we arrived? Effectively this is what we are doing when we delay providing epidural analgesia in favour of completing other tasks of questionable priority – episodes of acute, severe pain continue for a period where they could have been interrupted.

What judgements, conscious or subconscious are being made here?

## ARGUMENTS DEPRIORITISING LABOUR EPIDURAL ANALGESIA

For whatever reasons, in some circumstances it has become acceptable in the Australian health system to delay epidural analgesia in favour of other questionable priorities, at least up until the audit standard of half an hour. Of course, the demands for labour epidural analgesia will often compete with other *justifiably* higher priorities upon an anaesthetist's time, including other epidurals, or emergency caesareans for example. But the half-hour audit target has become, in some minds, an acceptable timeframe in *all* cases, rather than the limit of acceptability in the face of competing priorities.

Is there any justification for claiming that the severe pain of childbirth is experienced differently from, less severely than, other causes of acute pain? Appeals to the nature fallacy – the pain of labour is natural and therefore good, or at least less bad – may play a part in our subconscious thinking. But there is nothing *inherently* better about something that is “natural” (even if we discard difficulties in defining what is “natural”), and I have argued that there *is* inherent good in reducing acute severe pain. Some seek to lend a little more respectability to this fallacy by substituting “physiological” for “natural”. In any case, once again we are overriding a woman's autonomous desire for prompt analgesia based on our own flawed assertion of the good of “nature”.

It is often said that the pain of labour may be better tolerated than other causes of acute severe pain because of anticipation of the joy resulting from the process – a newborn baby. This *may* be true for many mothers and could be a factor in prioritising other patients' needs in competition with the anaesthetist's time. However, it seems weak justification for, for example, completing a tutorial in preference to providing relief of severe pain. It also makes a presumption regarding a woman's view of her own suffering and her own potential future joy – a judgement that she is surely better able to make than anyone else.

I have heard it said that the pain of childbirth is soon forgotten, more readily so than with other forms of pain. Again, there may be some truth to this, and fascinating experiments in pain perception (outside childbirth) targeting the “experiencing self” and “remembering self” raise very interesting ethical questions<sup>21</sup>. However, in delaying or denying analgesia on an assumption of modified memories, we encounter the same problems as when it is delayed or denied on the assumption of the joy of meeting your newborn. Further, can we prioritise, ethically, the “remembering self” over the “experiencing self”? Would it be ethical to, instead of giving an anaesthetic for major surgery, give only small amnesic doses of midazolam, neuromuscular blocking drugs, and peripherally acting adrenergic blockers to modify the stress response to surgery, such that the patient was conscious, in pain and fear during surgery, but had no memory of the events? (Analgesia could be given at the end of surgery, as memory returned). This is an extreme example of prioritising the remembering self over the experiencing self but illustrates that the latter cannot simply be dismissed.

Even accepting that the pain of childbirth is not experienced differently to other forms of acute severe pain, some may argue that the agency of the woman in falling pregnant is relevant in prioritising analgesia; that is, in choosing to have children, she should accept the pain of childbirth. Most anaesthetists would, I think, hesitate to air this view publicly (although it may enter their thoughts when raised from sleep at 3am to site an epidural). I shall not spend long arguing against denial of treatment in any area of medicine based on a perceived culpability on the part of the patient for their suffering. There may indeed be reasonable theoretical arguments for such an approach, but practically such a strategy is fraught, rife as it is with our own biases and value judgements. In childbirth, particularly, we need to be wary of this line of thinking. Unless one is an anti-natalist (who believes that existence is so loaded with misery that it is immoral to procreate) one must accept a certain level of human reproduction. If one accepts this level of reproduction as allowable, then (unless all deliveries are via elective caesarean) there will be the pain of labour. It could be asserted that when a mother has multiple children, the argument of culpability is stronger, and the priority given to her epidural diminished. Once more, however, judgements rife with bias and subjectivity are being made against the intrinsic good of relieving acute severe pain – pain that can be ended with our skills. We must be wary that disapproval at the societal and environmental effects of having many children is not translated into a punitive withholding of labour analgesia.

Another psychological intuition working against prompt provision of labour epidural analgesia may be the different moral weight commonly given to acts compared to omissions. As I shall expand on below, this intuition is often flawed.

## THE ACTS AND OMISSIONS DOCTRINE APPLIED (UNJUSTIFIABLY) TO EPIDURAL ANALGESIA

The acts and omissions doctrine states that, “... in certain circumstances, failure to perform an act, with certain foreseen and bad consequences, is morally less bad than to perform an act which has the identical foreseen bad consequences<sup>22</sup>.” It has some intuitive validity. Surely, we are not as culpable for the death of a child from starvation in a faraway country for *failing* to contribute to a charity that would have saved her life, as if we travelled there and *actively* killed her. Is the minister for health as culpable for the death of a patient as a consequence of underfunding as if he had shot them in the head? Consider some other cases. A specialist anaesthetist is sitting in the tearoom in order to give his junior registrar some independence in theatre. When the emergency buzzer sounds and a breathless nurse runs in saying the registrar cannot intubate or oxygenate the patient, he refuses to attend theatre. If the patient dies, how less morally culpable is the specialist than if he had actively killed the patient? Certainly, the gap in culpability between act and omission is substantially narrower than for the gap between failure to give charity and active killing, or between failure to fund a healthcare system adequately and active killing. A further famous example is proposed by the moral philosopher James Rachels:

“Smith stands to gain a large inheritance if anything should happen to his six-year-old cousin. One evening while the child is taking his bath, Smith sneaks into the bathroom and drowns the child, and then arranges things so that it will look like an accident.

Jones also stands to gain if anything should happen to his six-year-old cousin. Like Smith. Jones sneaks in planning to drown the child in his bath. However, just as he enters the bathroom Jones sees the child slip and hit his head, and fall face down in the water. Jones is delighted; he stands by, ready to push the child's head back under if it is necessary, but it is not necessary. With only a little thrashing about, the child drowns all by himself, “accidentally,” as Jones watches and does nothing.”

Many would say that Jones is no less guilty than Smith, and the gap in culpability between the act and the omission is zero. What these cases show is that there are differences, sometimes subtle, in conditions that can invalidate the act and omissions doctrine. Even when it appears a clear difference does exist between moral culpability for an act versus an omission, the *gap* between the two can be less than our intuition sometimes decrees. How culpable are we when, as anaesthetists specifically tasked with providing labour epidural analgesia, we delay provision to a woman requesting it? Is our moral obligation such that we are as culpable as if we had actively inflicted the pain with a cattle-prod ourselves for that forty minutes of delayed attendance? Of course, the situations are not wholly analogous here. Poking someone with a cattle-prod would of course have side effects well beyond the pain endured by the victim, including, among many others, fear within the community that they might be next. But my point is to encourage a psychological exercise comparing moral culpability in causing pain and leaving that pain unrelieved, when we have its relief in our immediate power, and are employed for that very reason. While it is a stretch to suggest that the anaesthetist delaying siting an epidural to finish watching a TV show is as guilty as one wielding a cattle-prod, I suggest the gap between culpabilities is narrower than many think.

## INSTITUTIONAL DEPRIORITISING OF LABOUR EPIDURAL ANALGESIA

I have argued that individuals deprioritise labour epidural analgesia through common attitudes and flawed arguments. Institutions, too, demonstrate this behaviour.

The UK National Institute of Clinical Excellence (NICE) instructs, “If a woman in labour asks for regional analgesia, comply with her request<sup>24</sup>”. In an accompanying NICE news article, midwife-led care is recommended for low-risk pregnancies, “... the evidence now shows that midwife-led care is safer than hospital care for women having a straightforward, low risk, pregnancy ... This is because the rate of interventions, such as the use of forceps or an epidural, is lower and the outcome for the baby is no different compared with an obstetric unit<sup>25</sup>.” The news article goes on to say that rapid access to an obstetric unit must be available should an epidural be requested. One justification for recommending midwife-led units is telling – that is, epidural complications can be prevented by not offering epidurals. Would NICE recommend drilling teeth without local anaesthetic because the rate of complications was lower, even if access to a nerve block could be provided on request? For the analogy to be tight, the drilling would have to continue while the patient was being transferred to a site where someone skilled in dental nerve blocks was available. Once again, we see the pain of childbirth treated differently from other causes of pain. Note, the case for midwife-led care in low-risk pregnancies has strengths separate from issues of analgesia. I am certainly not here arguing against such a model of care, but merely pointing out how *one* of its justifications reveals a particular attitude to pain in labour.

The contrasting guidelines of Royal College of Anaesthetists (RCoA) and the Australian and New Zealand College of Anaesthetists (ANZCA) regarding staffing and labour epidural provision demonstrate how institutional policies can affect a mother's access to effective analgesia. The RCoA's guidelines state that, "In units offering a 24-hour neuraxial analgesia service, the duty anaesthetist should be resident on the hospital site where neuraxial analgesia is provided<sup>26</sup>..." In contrast, the joint RANZCOG/ANZCA statement makes no explicit requirement for the anaesthetist to be resident, merely available in a "safe and timely manner<sup>26</sup>." The practical outcome of this difference is that small remote units in Australia can more easily provide an epidural service compared to similar units in the UK. For example, Esperance Hospital, 700 kilometres from Perth, with around 200-250 deliveries per year offers a 24-hour epidural service. In contrast, an island hospital in the UK, similarly remote in practical terms, with a similar number of deliveries, and similar anaesthesia staffing, does not offer a 24-hour epidural service. One reason for this is the requirement to provide on-site anaesthesia presence, rather than being on-call from home<sup>28</sup>. Is an overcautious attitude to epidural safety denying some women effective analgesia in the UK, or is a blasé attitude to epidural safety risking significant harm in Australia? That question is beyond the scope of this article, but it is important to consider if labouring women are not to be the victims of injustice.

## CONCLUSION

Hospitals in Australia are mostly well resourced to provide an excellent labour epidural service. Likewise, midwives and anaesthetists in the main strive to provide timely epidural analgesia to labouring mothers who want it. A few health professionals put forward explicit arguments loaded with value judgements (but little evidence) calling to override a labouring woman's autonomous request for an epidural. Beyond these easily refuted arguments, there exists in Australia an attitude towards the pain of childbirth that is not consistent with attitudes to other causes of severe pain. This can manifest itself in delays in providing the most effective treatment for the pain; delays that do not occur in situations outside childbirth. That many women decline analgesia in labour should not influence its provision to those who *do* desire it. Whether we relieve or neglect severe pain should not be a democratic decision, it should be the choice of the individual subject of the severe pain.

The pain of childbirth is unique. Analogies to other circumstances of acute severe pain cannot be faithful to all conditions, but I urge fellow anaesthetists to consider carefully, when called to site an epidural, whether any delay is just.

## REFERENCES

- Monteiro R, Salman M, Malhotra S, Yentis, S. Analgesia, anaesthesia and pregnancy: A Practical guide. 4<sup>th</sup> ed. Cambridge University Press. 2019. Chapter 26, Epidural analgesia for labour; p. 78-82.
- Hill A. Women in labour are being refused epidurals, official inquiry finds. The Guardian [Internet] 2020 Mar. [cited 2021 May 10] Available from: <https://www.theguardian.com/lifeandstyle/2020/mar/03/women-in-labour-being-refused-epidurals-official-inquiry-finds>.
- Snow J, Richardson B. On Chloroform and other anaesthetics: their action and administration. London: Churchill; 1858.
- Mets, B. Leadership in anaesthesia: Five pioneers of the deadly quest for surgical insensibility. Cambridge Scholars Publishing; 2020.
- Wakley T. Editorial. The Lancet. 1853 May 14; 61(1550):453.
- Snow J. On the mode of communication of cholera. London: John Churchill; 1849.
- Farr A. Early opposition to obstetric anaesthesia. Anaesthesia. 1980 Sep; 35(9): 896-907.
- Simpson J. Answer to the religious objections advanced against the employment of anaesthetic agents in midwifery and surgery. Edinburgh: Sutherland and Knox; 1857.
- Campbell D. It's good for women to suffer the pain of a natural birth, says medical chief. The Guardian [Internet] 2009 Jul. [Cited 2021 May 10] Available from: <https://www.theguardian.com/lifeandstyle/2009/jul/12/pregnancy-pain-natural-birth-yoga>.
- Walsh D. Pain and epidural use in normal childbirth. Evidence Based Midwifery. 2009 Sept. 7(3); 89-93.
- Monteiro R, Salman M, Malhotra S, Yentis, S. Analgesia, anaesthesia and pregnancy: A Practical Guide. 4<sup>th</sup> edn. Cambridge University Press. 2019. Chapter 169, Consent; p. 489-92.
- Orbach-Zinger S, Landau R, Harousch A, Ovad, O, Caspi L, Kormilov E et al. The Relationship between women's intention to request a labor epidural analgesia, actually delivering with labor epidural analgesia, and postpartum depression at 6 weeks: a Prospective Observational Study. Anesth Analg. 2018 May; 126(5):1590-7
- Ding T, Wang DX, Qu Y, Chen Q, Zhu SN. Epidural labor analgesia is associated with a decreased risk of postpartum depression: a prospective cohort study. Anesth Analg. 2014 Aug; 119(2):383-92.
- Lim G, Farrell L, Facco F, Gold M, Wasan A. Labor analgesia as a predictor for reduced postpartum depression scores: a retrospective observational study. Anesth Analg. 2018; 126:1598-605.
- Suhitharan T, Pham TP, Chen H, Assam PN, Sultana R, Han NL, et al. Investigating analgesic and psychological factors associated with risk of postpartum depression development: a case-control study. Neuropsychiatr Dis Treat. 2016 Jun; 12:1333-9.
- Eckerdal P, Kollia N, Karlsson L, Skoog-Svanberg A, Wikström AK, Högberg U, et al. Epidural analgesia during childbirth and postpartum depressive symptoms: A Population-based longitudinal cohort Study. Anesth Analg. 2020 Mar; 130(3):615-24.
- Nahirney M, Metcalfe A, Chaput KH. Administration of epidural labor analgesia is not associated with a decreased risk of postpartum depression in an urban Canadian population of mothers: a secondary analysis of prospective cohort data. Local Reg Anesth. 2017 Oct; 10:99-104.
- Yurashevich M, Carvalho B, Butwick AJ, Ando K, Flood PD. Determinants of women's dissatisfaction with anaesthesia care in labour and delivery. Anaesthesia. 2019 Sep; 74(9):1112-20.
- Mill JS. The Collected works of John Stuart Mill. (e-book) Prague: E-artnow, 2017.
- Childs D, Kansagra S. 10 health advances that changed the world. ABC News [Internet] 2007 Sep 20 [Cited 2021 May 10] Available from: <https://abcnews.go.com/Health/TenWays/story?id=3605442&page=1>.
- Kahneman D. Thinking fast and slow. London: Penguin Books; 2011. Chapter 35, Two selves; p.377-85.
- Glover J. Causing death and saving lives. London: Penguin Books; 1977. Chapter 7, Not striving to keep alive; p108-32.
- Rachels J. Active and passive euthanasia. NEJM. 1975 Jan 09; 292:78-80.
- National Institute for Clinical Excellence. Intrapartum care for healthy women and babies. NICE Guidance [Internet] 2017 Feb 21. [Cited 2021 May 10] Clinical guideline CG190. Section 1.9. Available from: <https://www.nice.org.uk/guidance/cg190/chapter/recommendations#pain-relief-in-labour-regional-analgesia>.
- National Institute for Clinical Excellence. Midwife-led units safest for straightforward births. [Internet] 2014 Dec 03 [cited 2021 May 10]. Available from: <https://www.nice.org.uk/news/article/midwife-led-units-safest-for-straightforward-births>.
- The Royal College of Anaesthetists. Guidelines for the provision of anaesthetic services. [Internet] 2020 Jan 31 [Cited 2021 May 10] Chapter 9: Guidelines for the provision of anaesthesia services for an obstetric population. Available from: <https://www.rcoa.ac.uk/gpas/chapter-9>.
- Joint RANZCOG/ANZCA Position statement on the provision of obstetric anaesthesia and analgesia Services. [Internet] 2015 Feb [Cited 2021 May 10]. Available from: [https://ranzco.org.au/RANZCOG\\_SITE/media/RANZCOG-MEDIA/Women%27s%20Health/Statement%20and%20guidelines/Workforce%20and%20Practice%20Issues/Provision-of-Obstetric-Anaesthesia-and-Analgesia-Services-\(WPI-14\)-\\_FINAL-February-2015.pdf?ext=.pdf](https://ranzco.org.au/RANZCOG_SITE/media/RANZCOG-MEDIA/Women%27s%20Health/Statement%20and%20guidelines/Workforce%20and%20Practice%20Issues/Provision-of-Obstetric-Anaesthesia-and-Analgesia-Services-(WPI-14)-_FINAL-February-2015.pdf?ext=.pdf).
- Personal communication.



# Assessment and perioperative medicine

## **Benefits of anaesthesia preassessment clinics**

Saleem Khojraty, Rishi Mehra, Aaron Paul

---

## **Use of mobile applications in perioperative medicine**

Josh Szentel, Rani Chahal, Gregg Miller

---

## **How can anaesthetists talk to patients with obesity?**

Natalie Smith, Anthony Hodsdon, David A Story

---

## **Preparing the elderly patient for elective non-cardiac surgery**

Naomi Osborne, Leena Nagappan, Kevin Kwan

---

## **Perioperative melatonin: Too good to be true?**

Marli Smit, Dale Currigan

---

## Benefits of anaesthesia preassessment clinics

### Saleem Khoyratty FANZCA

Specialist anaesthesiologist at The Alfred hospital and The Austin Hospital, Melbourne, Australia

Dr Saleem Khoyratty has a special interest in perioperative medicine and is currently undertaking a perioperative masters through Monash University.

### Rishi Mehra MBBS FANZCA PgDipEcho, NBE Diplomate, MMed (PeriopMed)

Specialist anaesthesiologist at The Alfred hospital, Melbourne, Australia

Dr Rishi Mehra has special interests in perioperative medicine and preadmission screening. Assisted with the formulation, setup and unit co-ordination of the Alfred Perioperative Medicine Short Course and Masters of Perioperative Medicine.

### Aaron Paul MBBS(Hons), BBiomedSc, FANZCA

Specialist anaesthesiologist at The Alfred hospital, Melbourne, Australia

Dr Aaron Paul has completed the perioperative medicine short course through Monash University and is undertaking further study in point of care ultrasonography.

All authors are proponents of perioperative medicine and believe preassessment clinics form a vital part of improving perioperative patient care.

## INTRODUCTION

Preassessment clinics (PACs) were first suggested by Lee in 1949<sup>1</sup>. These clinics were initially designed as a practical approach to allow for day of surgery presentation. As the transition to same day surgery increased, the requirement for PACs also increased. Now preassessment clinics are a routine part of perioperative care with several models of PAC staffing being used in Australia and New Zealand. These range from nurse-led clinics to those run by physicians/anaesthesiologists.

While the initial drive to reduce day of surgery cancellation perhaps hastened the introduction of these clinics, the opportunity to optimise patients and therefore improve outcomes have increased their widespread use. While preassessment clinics do not regularly change management of the anaesthetic – as highlighted in a tongue in cheek publication<sup>2</sup> – this should not be seen as a failure of them or a reason to negate their use. This article explores the evidence surrounding PACs and their effects on perioperative outcomes. As there are different models of PACs this article looks at the evidence around the different perioperative components of a clinic. Finally, the article will explore some of the future directions for development of PACs.

## CANCELLATION OF OPERATIONS

Studies have demonstrated a reduction of greater than 50 per cent in cancellation rates<sup>3-7</sup> by using anaesthesiologist-run PACs. Specific cohorts of surgical patients have similar findings. Surgical cohorts have included cardiac surgery<sup>8</sup> and vascular surgery<sup>9</sup>. Studies have also found significant reductions in cancellation rates in nurse-led preassessment clinics<sup>10</sup>.

A retrospective cross-sectional descriptive study performed in Sydney, Australia<sup>11</sup> looked at its preoperative service. It analysed more than 12,500 patients presenting for elective surgery over a four-year period. It found a cancellation rate of 0.46 per cent for anaesthesia related reasons. The most common reason was an upper respiratory tract infection which accounted for 33 per cent of their cancellations. The next most common group of reasons were potentially preventable. These included patient non-adherence to fasting guidelines and staff not acting on preoperative investigations. Preassessment clinics may reduce some of these preventable cancellations. Cancellations can also reduce theatre efficiency. Fischer noted that theatre turnover increased by more than 90 minutes when a patient was cancelled for various reasons such as subsequent patient preparedness and fasting status<sup>7</sup>.

## MORTALITY

Preassessment clinic is an opportunity to optimise a patient's medical comorbidities. Optimisation offers the theoretical benefit of allowing patients to better tolerate the perioperative stressors of an operation. There is a lack of high-quality evidence to support this hypothesis and numerous confounders would make this difficult to prove. Evidence however is starting to emerge that there is an association between improved fitness and reduced perioperative complications, but extension to reductions in mortality is lacking.



The impact of PACs on mortality is conflicting with some studies reporting reductions in mortality and others not. A retrospective analysis at a New York Hospital, USA,<sup>12</sup> examined data from more than 64,000 patients. They compared patients who had attended their preassessment service, to those who had not. Propensity score matching was used. In-hospital mortality was low in both groups. However, in-hospital mortality was significantly lower in the group attending PAC (odds ratio, 0.48; 95% confidence interval (CI), 0.22 to 0.96,  $P = 0.04$ ). While in a single centre study, Carlisle<sup>13</sup> reviewed more than 300 patients at their centre and followed up the patients for almost 1000 days. Despite being older, having worse renal function and higher American Society of Anesthesiology (ASA) scores, patients who attended a PAC had significantly reduced mortality (hazard ratio 0.42, hazard ratio 95% CI 0.23 - 0.75,  $P=0.006$ ). The authors hypothesised that appropriate risk stratification and utilisation of postoperative high dependency beds led to improved outcomes in their cohort of patients. In their study, twice the number of patients who attended PAC utilised a high dependency unit (HDU) bed (24% v 12%). Cantlay<sup>9</sup> also investigated patient outcomes at their tertiary centre's preassessment clinic over a two-year period. They were able to show a decrease in mortality from 14.5% to 4.8% after implementation for vascular surgery. In this study patient numbers were limited to 118 and included only patients having infrarenal open abdominal aortic aneurysm repair.

Contrary to these studies, a larger multi-centre state-based database derived study conducted in Ontario, Canada, showed no difference in mortality<sup>14</sup>. In this cohort of more than 270,000 patients, 39 per cent of patients underwent a preassessment by an anaesthesiologist between 1994 and 2004.

## MORBIDITY

The Grattan Institute is an independent Australian institution whose purpose is to develop high quality public policy for Australia's future. In his publication "All complications count. Using our data to make hospitals safer"<sup>15</sup> the Health and Aged Care Program Director Dr Stephen Duckett provided the following data:

- One in nine patients (approximately 900,000) who go into hospital suffer a complication.
- One in four (725,000) patients who require an overnight stay in hospital suffer a complication.
- If the bottom 90 per cent of institutions reduced their complication rate to the same incidence as the top 10 per cent of hospitals, overall complication rates would reduce by 25 per cent.
- This reduction in complications could save healthcare \$A1 billion per year.
- The reduction in bed days associated with these complications could lead to 250,000 more patients being treated by our healthcare system per year.

A randomised controlled trial in a single tertiary centre in London, UK, showed geriatric patients undergoing vascular surgery had reductions in many common complications with a comprehensive geriatric assessment compared to routine anaesthetic preassessment for this institution. It should be noted this was a secondary outcome in this trial<sup>16</sup>.

It is assumed by some clinicians that improving preoperative fitness will improve outcomes. Evidence is starting to emerge that this is the case. A randomised controlled trial (RCT) published in 2018 examined patients undergoing elective abdominal surgery. The trial was relatively small with less than 70 patients in each arm. The intervention arm included standard care and prehabilitation in ASA 3 and 4 patients. The intervention was multifactorial and included motivational advice and high intensity training. The study showed strong evidence of an increased anaerobic threshold in the intervention arm (change in endurance time 135 (218) %;  $P < 0.001$ ) and a reduction in complications by 51% (relative risk 0.5; 95% CI, 0.3–0.8;  $P = 0.001$ )<sup>17</sup>.

However, another small RCT examined elderly frail patients undergoing colorectal surgery. A multimodal prehabilitation program involving nutrition, exercise and psychological interventions was utilised. This was either given before or after surgery. The investigators looked at complications in the first 30 days postoperatively and no difference was found<sup>18</sup>.

There are a variety of trials being run to further investigate this issue. These include trials looking at inspiratory muscle training<sup>19</sup> as well as exercise and psychological intervention on postoperative complications<sup>20</sup>.

PACs would complement these interventions by identifying high-risk patients who would benefit from evidence-based prehabilitation. This may involve a combination of history, examination and objective assessment such as respiratory function tests, cardiopulmonary exercise testing or more simple exercise measurements such as a six-minute walk test or DASI (Duke Activity Status Index). Patients may also need to be seen earlier in their perioperative journey to take full advantage of the benefits conferred by prehabilitation.

## LENGTH OF STAY IN HOSPITAL

The Research into Elderly Patient Anaesthesia and Surgery Outcome Numbers (REASON) study<sup>21</sup> was a multicentre, observational, prospective study which showed that patients who had one or more complications stayed a week longer in hospital. By reducing complications it is likely that length of stay can also be reduced. This will reduce healthcare costs and allow more patients in society to be treated by a healthcare service<sup>15</sup>. A study investigating a preassessment service showed reductions in length of stay in vascular patients<sup>16</sup>. This service, run in a tertiary London, United Kingdom, hospital, compared a comprehensive geriatric assessment (CGA) using peer reviewed protocols to drive consistent decisions against routine preoperative care. Routine preoperative care was a nurse run assessment with escalation as required to optimise patients. The study enrolled 176 patients randomised to these two arms. The primary outcome was length of stay. There was very strong evidence of a reduced length of stay in patients in the CGA group (mean difference 2.5 days, 5.5 days in routine care group versus 3.5 days in intervention group, ratio of geometric means 0.60, 95% CI. 0.46 to 0.79;  $P < 0.001$ ).

## APPROPRIATE UTILISATION OF POSTOPERATIVE RESOURCES

Appropriate utilisation of intensive care unit (ICU) beds is essential to an effective perioperative service. Most operations, however, do not require this level of support. Working out which high-risk patients are appropriate for ward-based care and which patients require intensive care will contribute to the cost-effectiveness of a perioperative service. The cost per day of an intensive care bed varies from country to country. In the UK it is estimated to be £1087, or approximately \$A2000<sup>22</sup>. In Australia it is estimated to have a mean daily cost of \$A4375<sup>23</sup>. This compares to a ward bed per day cost of £239<sup>22</sup>. Both ward and intensive care beds are a limited resource and should be used appropriately. PACs can utilise a combination of clinical judgement, investigations and risk stratification tools to estimate perioperative risk for a patient.

Swart et al<sup>24</sup> investigated the use of a risk stratification tool for 30-day mortality. This risk stratification tool was developed by one of the co-authors and was multifactorial. It involved patient demographics as well as results from cardiopulmonary exercise testing. It was specifically designed for the cohort of patients treated at this hospital. Patients presenting for elective colorectal surgery were divided to either ward-based care (low-risk <1% risk of mortality), ICU/high dependency unit (HDU) care (high-risk >4% risk of mortality, expected to be cancelled if no bed) or ICU/HDU care but could proceed if no bed (intermediate risk 1-3% risk of mortality). The authors' primary aim was to see if risk prediction tools could be used to determine postoperative destination. Cost-analysis per day was also quantified. This was done by calculating the number of ward, HDU and ICU bed days for a patient. These values were then multiplied by the UK standard results tariff. Table 1 shows the cost-analysis per day for intermediate risk patients in a HDU bed (68 patients) or in a ward bed (139 patients).

**Table 1. Costs per day for intermediate risk (1-3%) patients depending on immediate postoperative destination. Adapted from Swart et al<sup>24</sup>**

Intermediate risk patient destination immediately postoperatively	Average cost per day (£)
High dependency unit bed	3236
Ward bed	3613

Requirements for emergency laparotomy in the cohort of patients varied (see Table 2). Cost-analysis showed the cost of an unplanned ICU/HDU admission was greater than the elective use of an ICU/HDU bed in an intermediate-risk patient for elective colorectal surgery in this institution.

Risk stratification tools are continuously developed for specific cohorts of patients. Improvement in these tools combined with predetermined operations and definitions of high-risk patients within an institution could delineate which cohort of patients need ICU/HDU care and which patients can be managed on a ward. This may need refinement over time. In the study by Swart and colleagues, the utilisation of intensive care beds was changed within the institution as an excessive number of patients were being postponed/cancelled in the intermediate/high-risk group. The combination of objective risk stratification tools, clinical judgment, pragmatism and implementation to the correct cohort of each institution's resources could provide another valuable outcome of PACs. As shown by Swart and colleagues<sup>24</sup>, this may in fact save money. The authors noted that the majority of patients who electively went to HDU/ICU postoperatively were in HDU/ICU for a short period (average 1.4 days) but re-laparotomy procedures would occur later (greater than 3 days) in the patient's journey. The authors hypothesised that the initial improved care allowed better perfusion of the anastomosis.

Anastomotic leak was the most common finding at emergency laparotomy. The most common reason for emergency admission to HDU/ICU was pneumonia. Sixteen per cent of patients in the intermediate risk group who went to the ward initially required an emergency admission to HDU/ICU. Of the 68 patients admitted to HDU/ICU postoperatively with intermediate risk scoring, 64 patients had an arterial line with blood gases being taken and 29 patients received medications only able to be administered in a HDU/ICU environment (vasopressor or management of atrial fibrillation).

**Table 2. Proportion of patients in different postoperative mortality risk groups who underwent emergency laparotomy after their elective procedure. Adapted from Swart et al<sup>24</sup>**

Group	Emergency laparotomy rate (%)
High risk (>4%) Electively had ICU care after surgery	4.3%
Intermediate risk (1-3%) Electively had ICU care after surgery	0%
Intermediate risk (1-3%) Electively had standard ward bed care after surgery	10%
Low risk (<1%) Standard ward bed care after surgery	1.1%

These findings were corroborated by the 2nd Sprint National Anaesthesia Project: Epidemiology of Critical Care provision after Surgery (SNAP-2: EpiCCS) study<sup>25</sup>. This prospective cohort study in the UK was performed over seven consecutive days. It showed 13.9% of the 14,936 patients were cancelled for inpatient surgery. Requiring a postoperative critical care bed was an independent risk factor for cancellation (odds ratio 2.92,  $p < 0.001$ ) along with a hospital having an emergency department.

The perceived benefit of critical care postoperatively is likely to be the ability to monitor patients more closely in an area with increased nursing to patient ratios. This may allow for earlier detection of deteriorations and reduce the issue of “failure to rescue”<sup>26</sup>. Therefore, this balance between closer monitoring and increased nurse to patient ratios needs to be balanced against the increased risk of cancellation. Accurate identification of the patients who require postoperative critical care is vital. The SNAP2-EpiCCS investigators examined inpatient surgery across three countries (UK, Australia and New Zealand). After excluding obstetrics due to the low mortality in this population, they found a postoperative mortality of 1.2% in their 22,216 patients. In a subsection of high-risk patients this increased to 2%. These findings correlate well with another study by Abbott et al who found mortality to be 1.1% of over 39.5 million surgical episodes in the UK<sup>27</sup>. The authors found that despite the availability of risk-stratification tools, these were not commonly used<sup>28</sup>. The study showed that while clinician judgement was good, the utilisation of an objective risk calculator – in this case the surgical outcome risk tool (SORT) – when combined with clinician judgement improved the ability to discriminate high-risk patients. The study also found that clinician judgement was pessimistic. This may mean when clinician judgement is used alone, an overuse in critical care beds, which vary from country to country (Table 3), could occur with a subsequent increased risk of surgery cancellations due to bed unavailability.

**Table 3. Variation in critical care beds per 100,000 population in different countries<sup>29</sup>**

Country	Critical care beds per 100,000 population
United Kingdom	9.33
Australia	14.05
New Zealand	9.14

The REASON study also showed that patients who had an unplanned ICU admission had an increase in perioperative risk<sup>21</sup>. Pearse et al showed in the European Surgical Outcomes Study (EUSOS) study that the 73% of patients who died in their 46,539 patients did not get admitted to ICU<sup>30</sup>.

## LONGER TERM BENEFITS

Using preassessment clinics can be used to provide a “teachable moment” and thus can have longer term benefits on a patient’s health. Smoking is associated with both negative long-term health impacts and negative perioperative outcomes<sup>31</sup>. As perioperative physicians we have an opportunity for general health promotion, reducing perioperative morbidity and mortality and also improving long-term health outcomes.

Most patients acknowledge the detrimental effects of smoking on long-term health. A study performed in British Columbia, Canada, screened more than 1700 patients who presented for elective surgery for smoking status. Of those considered suitable, 161 completed a telephone survey. Fifty-nine per cent of participants who completed the telephone survey were female. They found 7.5% of patients quit smoking in the preoperative eight-week period. An additional 38.8% reduced their smoking in the preoperative period. Interestingly the telephone survey revealed that only 50% of patients were aware that smoking was detrimental perioperatively. Fifty per cent were informed about reduced smoking/quitting smoking in the lead up to surgery. Therefore, it is possible that many patients are not aware of the immediate detrimental effect of smoking on perioperative outcomes. A study from 2008<sup>32</sup> followed 120 patients who were randomised to either smoking cessation interventions versus no intervention. At one year follow-up, there was strong evidence of a reduction in the proportion of patients remaining smoking free who received the intervention compared to those who received no intervention (13 in 60 patients (22%) versus 2 in 60 (3%),  $P < 0.01$ ). A further multi-centre, double-blind, RCT by Wong et al<sup>33</sup> followed 286 non-cardiac surgery patients over three, six and 12 month periods. At each stage there was increased smoking abstinence in the patients receiving varenicline, a tobacco disorder treatment medication, compared to the placebo group. There is therefore some evidence that the perioperative period can be used as a teachable moment both immediately and in the long term.

The PAC consult, however, can be anxiety provoking for patients. A lot of information is given to a patient and therefore smoking cessation advice may not be recalled. Competing interests to optimise patients and convey information within time constraints can mean smoking cessation advice is suboptimal. Other issues such as rapport and whether a patient is willing to discuss these sensitive topics can also impede discussions in PAC.

The importance of having an effective discussion is further strengthened by the potential economic benefits. There are approximately 20,000 smoking-related deaths annually in Australia with 1.7 million smoking-related hospital inpatient episodes. The net tangible costs of smoking are estimated to be \$19.2 billion (range \$16.3 billion to \$24.0 billion)<sup>34</sup>.

Perioperatively we therefore have a teachable moment with a patient who is motivated to improve their outcomes. We have something which is shown to have benefits both perioperatively and long-term for the patient. It also has benefits for the hospital, society and the economy. Similar interventions could be applied to other comorbidities such as obesity, obstructive sleep apnoea, diabetes and substance use disorders including increased alcohol use.

## THE EVOLVING STRUCTURE OF PREASSESSMENT CLINICS

Studies have been performed to look at the utilisation of telephone-based PACs<sup>35</sup>. Telephone preassessments are considered a useful part of PACs. In Australia they can be particularly helpful with patients in remote regions, avoiding the need for patients/families/carers to travel extensive distances. The recent COVID-19 pandemic has brought telephone consultation, as well as the use of other modern solutions such as telehealth, to the forefront<sup>36</sup>. A hybrid model where both in person and virtual/telephone reviews seems likely in the future.

## WHO SHOULD RUN PREASSESSMENT CLINICS?

Different models of how preassessment clinics are run are seen in different institutions. A RCT<sup>37</sup> comparing junior doctors and appropriately trained nurses across a range of surgical specialities showed no difference in cost. Various factors such as funding, resources and tradition are likely to dictate the personnel running a PAC in any given institution.

Many medications may need to be reviewed in the perioperative period. Tackling this issue is multifactorial and potentially costly. One consideration is the utilisation of a pharmacist in PACs. A prospective, single centre study<sup>38</sup>, looked at how many medication errors were picked up by the utilisation of a pharmacist in PAC. This study was conducted in patients who required at least one night in hospital. The study found that 95% of patients recorded at least one medication discrepancy. Sixty-one per cent of patients were observed to have a “clinically meaningful” discrepancy in their medications noted in a preassessment without a pharmacist. These findings were supported by a study by Marotti<sup>39</sup>. This study performed in Newcastle, New South Wales, Australia, looked at 120 patients in each arm. It compared usual practise, to a pharmacist

taking a medication history, and finally looked at a pharmacist taking a medication history and prescribing medication for the patients postoperatively. This study was conducted in patients who required at least one night in hospital. The number of missed doses of medications was significantly lower in the last group with pharmacists prescribing (3.21 [2.89-3.52 95% CI] control v 3.3 [2.98-3.63 95% CI] pharmacist history v 1.07 [0.9-1.25 95% CI] pharmacist prescribing,  $p < 0.001$ ). The number of medication errors was also significantly lower in the pharmacist prescribing group for both frequency (0.29 [0.19-0.39 95% CI] v 0.07 [0.02-0.12 95% CI] v 0.015 [0.00-0.06 95% CI]  $p < 0.001$ ) and dosing errors (0.48 [0.35-0.61 95% CI] v 0.12 [0.05-0.18 95% CI] v 0.02 [0.00-0.04 95% CI])<sup>39</sup>.

The increasing complexity of patients presenting for surgery, combined with the multitude of factors which may make medication management perioperatively challenging provides another reason why a PAC may be useful, but in particular one involving a pharmacist. The cost of employing a pharmacist needs to be balanced by the potential medication issues (that is, cancellation). These costs are difficult to determine.

## PREOPERATIVE INVESTIGATIONS

In the UK from 2002-2012 there was an increase of 60% in the number of operations performed within the NHS. This was an increase of around four million operations<sup>40</sup>. Unnecessary investigations will cause increased costs, utilisation of resources and potentially cause increased anxiety to patients<sup>41</sup>. Studies have shown how implementation of guidelines into PACs can reduce cost<sup>42,43</sup>. A study performed in Stanford, USA, compared investigations requested before and after the implementation of an anaesthesiologist clinic. There was a reduction in preoperative investigations of 55.1% with no adverse consequences noted from this reduction (Table 4)<sup>7</sup>. Investigations already performed by the general practitioner (GP) should be made available at preassessment to further reduce unnecessary investigations being performed.

**Table 4. Reduction of preoperative investigations after implementation of an anaesthesiologist preassessment clinic<sup>7</sup>**

	Before anaesthesiologist run preassessment clinic	After anaesthesiologist run preassessment clinic
Total preoperative tests (number)	21,904	11,862
Number of patient tests (average)	6.13	2.75

Fischer went on to show a cost saving of \$US112.09 (\$A144) per patient in 1996. Extrapolating this out to an annual figure for their clinic over a year this equated to a cost saving of over \$US1.01 million (\$A1.3 million). PAC may therefore streamline preoperative investigations.

## DECISIONAL REGRET

Decisional regret is the situation where a patient feels that if they made a different decision their outcome may have been better. A systematic review analysed 73 patient-centred studies about this issue<sup>44</sup> and 57.5% of the studies involved oncological patients. It found an average prevalence of decisional regret of 14.4% in surgical patients. This equates to approximately one in seven operations being associated with postoperative patient regret. PACs may offer a better opportunity to achieve more shared decision making, more patient participation in decision making and reductions in decisional regret.

## PATIENT SATISFACTION

Improving patient satisfaction is one component of the triple aim of healthcare improvement (see Figure 1)<sup>45</sup>.

**Figure 1. Triple aim of healthcare<sup>45</sup>**

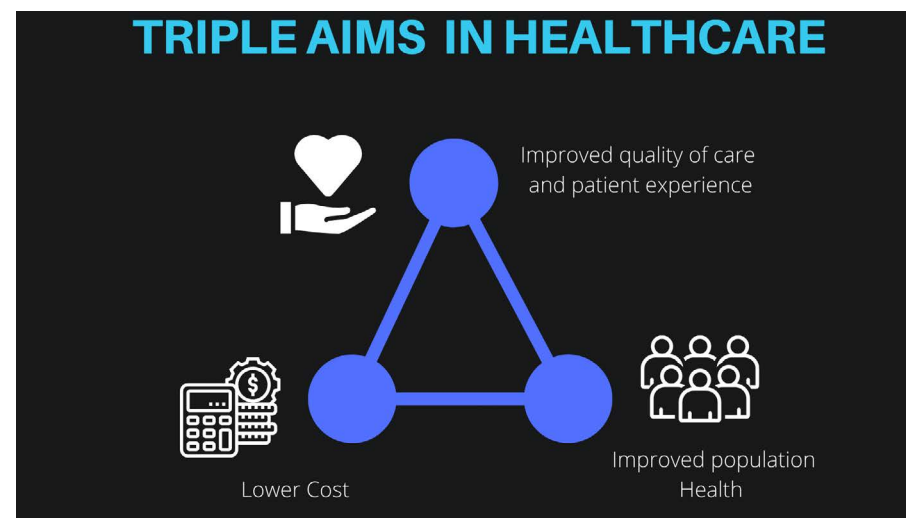

Consumer involvement with patients assisting in the establishment of a preassessment service can improve patient satisfaction with that service. It can have other consequences such as increased public trust in their healthcare system. Harnett et al surveyed patients about their experience and satisfaction with their PAC visit at a tertiary centre<sup>46</sup>. After implementation of consumer feedback they repeated the survey two years later. All 14 questions produced higher scores with three questions reaching statistical significance ( $p < 0.01$ ) of a difference in the post-feedback survey. These were in the areas of:

- Explanation about the purpose of the PAC.
- Courtesy and efficiency of the clinic staff.
- Satisfaction with waiting times.

Improvements in communication can therefore potentially improve patient satisfaction with a service. These results have been replicated in another study by Pakdil and Harwood<sup>47</sup>. Improving communication by using written information which can be taken away by the patient can also increase satisfaction<sup>48</sup>. This study was done in the PAC and increased knowledge about the anaesthetic and different options available in areas such as pain relief. This would be of particular benefit to patients who have a significant interval between their PAC and their operation. This may increase as patients are seen earlier in their perioperative journey. This may also be of benefit to patients who have relatives/friends who are involved in their care but cannot attend the clinic with them. While a discussion about health literacy is beyond the scope of this article it is widely acknowledged that patients with poorer health literacy have poorer healthcare outcomes<sup>49</sup>. The ability to spend greater time with patients combined with the use of interpreters, family and friends are further benefits of PAC which are again difficult to measure.

## INTERDISCIPLINARY REFERRALS

The ability to refer patients for further investigations and allow these results and consultations to lead to improved shared decision making for high-risk patients is something that is constantly developing in the perioperative field. Cantlay<sup>9</sup> described an example of this through a vascular preassessment service. Cantlay and colleagues came up with a pragmatic referral system to identify patients most in need of further cardiac investigations, ensuring their system could handle the extra workload. The authors monitored the number of referrals for stress testing and their outcomes as well as referrals requiring coronary angiography/percutaneous coronary intervention (PCI)/coronary artery bypass grafting (CABG). The utilisation of PCI/CABG perioperatively is controversial, something the authors acknowledged. This does show the power of the

PAC to stimulate conversations with other specialities to overcome these controversial areas of perioperative practice. The paper also discussed how 26 patients did not proceed to surgery. Many of these were high-risk patients who were investigated. This led to shared decision making with the patients that the benefit of surgery was likely outweighed by the potential morbidity and mortality associated with surgery.

### COST-EFFECTIVENESS

A preassessment clinic will have staffing costs associated with it. There are, however, a multitude of ways in which a PAC may reduce healthcare system costs. These include:

- Reduce day before surgery admission.
- Reduce cancellation and increase theatre efficiency.
- Reduce utilisation of unnecessary preoperative investigations.
- More appropriate use of critical care beds.
- Optimisation of comorbidities (for example, smoking cessation).
- Reduction in perioperative complications.

Many of these are difficult to measure and are not reliably obtained for every patient attending clinic. There is limited evidence about the cost-effectiveness of preassessment anaesthesia clinics.

### THE PERIOPERATIVE PATHWAY

In a traditional model preassessment occurs shortly before the operative day (Figure 2). However, the preoperative period could start much earlier. Grocott et al<sup>50</sup> have proposed this in their recent review centred around improving the “triple aim” in healthcare preoperative pathways.

The preoperative pathway should ideally start at an initial consultation with the general practitioner. Grocott suggested re-designing the preoperative pathway for patients presenting from a more traditional model to this alternative model which would allow more time for optimisation (Figure 3).

Figure 2. Traditional preoperative pathway<sup>50</sup>

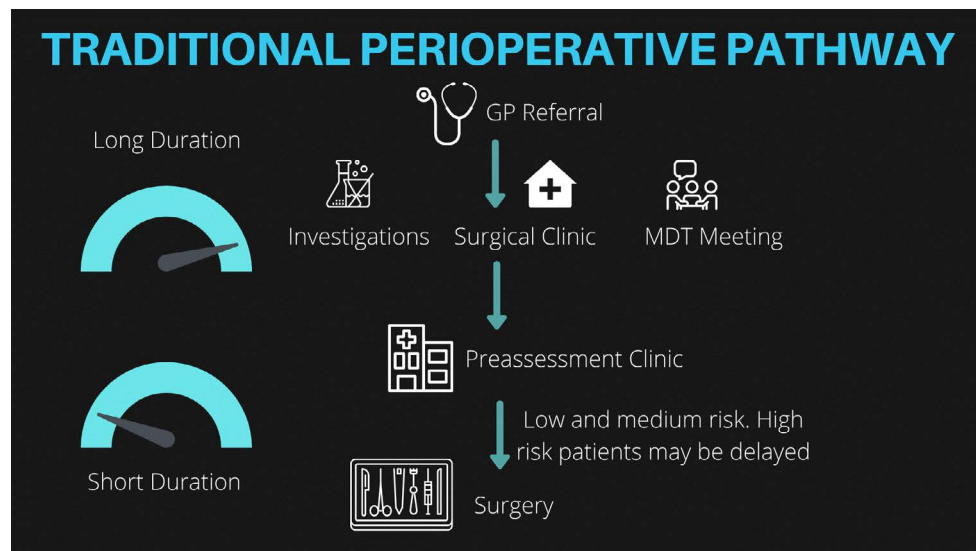
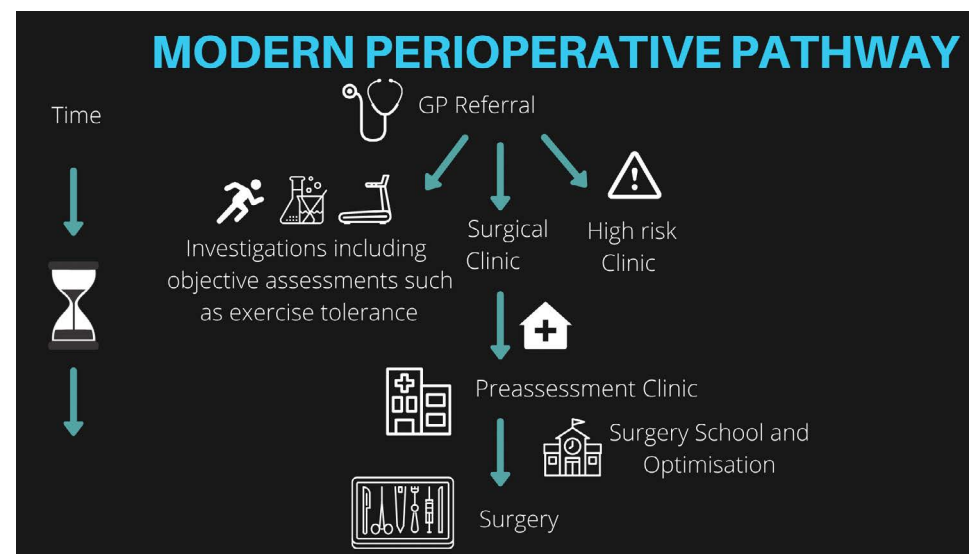

Figure 3. Alternative perioperative pathway<sup>50</sup>



Grocott also highlighted other potential benefits apart from optimisation of comorbidities. This model would include increased use of shared decision making, smoking cessation, dietary modifications and optimal analgesia which assist in reducing perioperative complications. It should be remembered that many of these will have longer term benefits even if surgery is declined by the patient. Grocott's article also highlights the reality that surgery is most likely to be declined by the most unwell patients. These are the patients who are most likely to develop complications postoperatively and therefore have the most to benefit from optimisation and shared decision making perioperatively.

### THE FUTURE

Preassessment clinics are well established for elective surgery in many countries. The constituents of a PAC should be individualised to each institution. The ability to remain flexible, to evaluate updated evidence, incorporate technology and to change preassessment to an increasingly efficient and cost-effective model will ensure PACs remains relevant to modern practice.

High quality perioperative evidence regarding patient-centered outcomes and the health economic impact of PAC is required and is emerging through pragmatic clinical trials using recognised patient-centred perioperative outcomes<sup>51</sup>. An ideal PAC should work in conjunction with a multidisciplinary team of surgeons, other physicians and healthcare professionals (dietitians, pharmacists) to identify patients who would benefit from interventions. This would work alongside well established, but continually refined institution based preoperative pathways for certain patient cohorts. The ideal PAC brings this all together and aids in providing the communication for patients which allows improved patient centred perioperative care. Ultimately the return to functional status, reductions in complications, length of stay and decisional regret would be the aim for perioperative healthcare.

### CONCLUSION

Preassessment services have many benefits (Figure 4). Decisions need to be made at an institutional level to formulate the optimal preassessment service for that hospital. Each institution would also need to examine the utilisation of screening tools to identify patients most likely to benefit from PAC. Internal guidelines need to be made to streamline referral pathways for further investigations. These guidelines will need to be individualised to the local institution whilst reflecting national/international consensus. Preassessment guidelines must also incorporate new and emerging evidence. Finally, ongoing audit and evaluation of a clinic's adherence to best practice guidelines should be part of every PAC. Ensuring patients are adequately optimised for surgery should be combined with a more long-term approach to the health benefits of optimisation. This can be further combined with information about expectations and goals perioperatively which may involve family and friends. The ability to spend time discussing risks perioperatively, answer questions and utilise interpreters are also further benefits of PACs. The implementation of technology such as telehealth and smart technology can allow healthcare providers to individualise care to a patient's circumstances and allow us to deliver a well-informed, optimised and satisfied patient on the day of surgery.

**Figure 4. Infographic summarising some of the potential benefits of preassessment clinics**

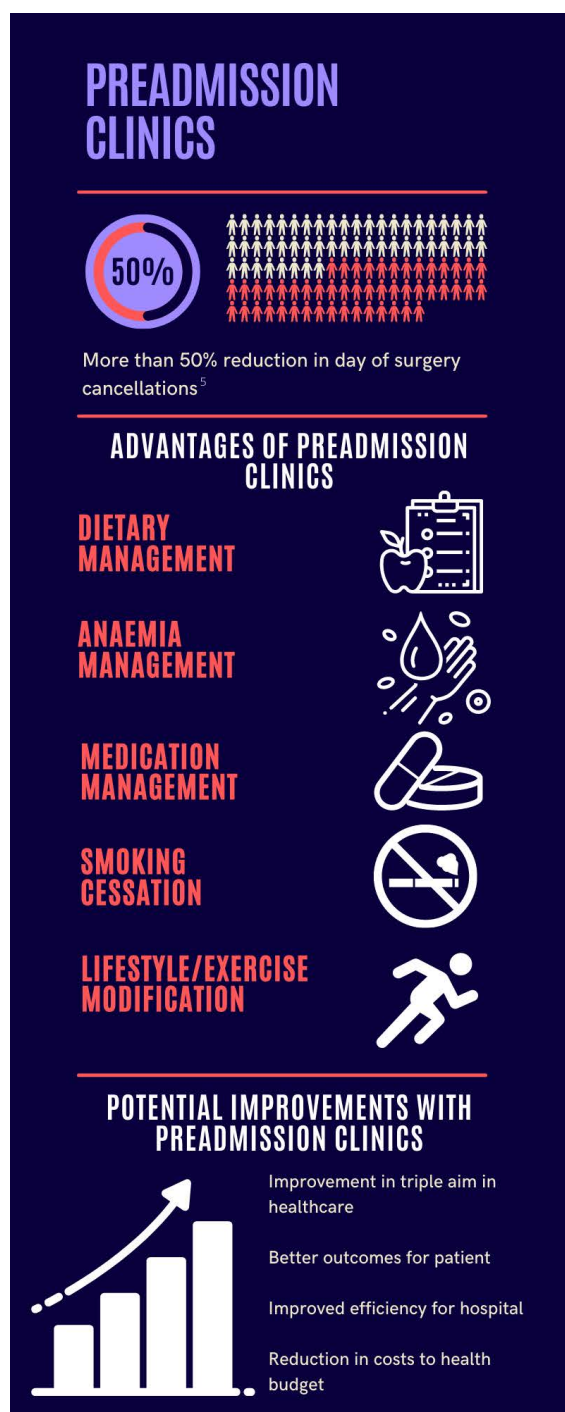

## REFERENCES

- Lee JA. The anaesthetic out-patient clinic. *Anaesthesia*. 1949 Oct;4(4):169–74.
- Chrimes N. Complete relinquishing of anaesthetic conscientiousness, optimisation and nuance (CRAC-ON) trial. *Anaesthesia*. 2016;71(12):1408–9.
- Ferschl MB, Tung A, Sweitzer B, Huo D, Glick DB. Preoperative clinic visits reduce operating room cancellations and delays. *Anesthesiology*. 2005 Oct;103(4):855–9.
- McKendrick DRA, Cumming GP, Lee AJ. A 5-year observational study of cancellations in the operating room: Does the introduction of preoperative preparation have an impact? *Saudi J Anaesth*. 2014 Nov;8(Suppl 1):S8–14.
- Knox M, Myers E, Hurley M. The impact of pre-operative assessment clinics on elective surgical case cancellations. *Surg J R Coll Surg Edinb Irel*. 2009 Apr;7(2):76–8.
- van Klei WA, Moons KGM, Rutten CLG, Schuurhuis A, Knape JTA, Kalkman CJ, et al. The effect of outpatient preoperative evaluation of hospital inpatients on cancellation of surgery and length of hospital stay. *Anesth Analg*. 2002 Mar;94(3):644–9; table of contents.
- Fischer SP. Development and Effectiveness of an Anesthesia Preoperative Evaluation Clinic in a Teaching Hospital. *Anesthesiology*. 1996 Jul 1;85(1):196–206.
- Farasatkish R, Aghdaii N, Azarfarin R, Yazdani F. Can preoperative anaesthesia consultation clinic help to reduce operating room cancellation rate of cardiac surgery on the day of surgery? *Middle East J Anaesthesiol*. 2009 Feb;20(1):93–6.
- Cantlay KL, Baker S, Parry A, Danjoux G. The impact of a consultant anaesthetist led pre-operative assessment clinic on patients undergoing major vascular surgery\*. *Anaesthesia*. 2006;61(3):234–9.
- Rai MR, Pandit JJ. Day of surgery cancellations after nurse-led pre-assessment in an elective surgical centre: the first 2 years. *Anaesthesia*. 2003 Jul;58(7):692–9.
- Emanuel A, Macpherson R. The anaesthetic pre-admission clinic is effective in minimising surgical cancellation rates. *Anaesth Intensive Care*. 2013 Jan;41(1):90–4.
- Blitz JD, Kendale SM, Jain SK, Cuff GE, Kim JT, Rosenberg AD. Preoperative Evaluation Clinic Visit Is Associated with Decreased Risk of In-hospital Postoperative Mortality. *Anesthesiology*. 2016;125(2):280–94.
- Carlisle J, Swart M, Dawe EJC, Chadwick M. Factors associated with survival after resection of colorectal adenocarcinoma in 314 patients. *Br J Anaesth*. 2012 Mar 1;108(3):430–5.
- Wijesundera DN, Austin PC, Beattie WS, Hux JE, Laupacis A. A Population-Based Study of Anesthesia Consultation Before Major Noncardiac Surgery. *Arch Intern Med*. 2009 Mar 23;169(6):595–602.
- Duckett SJ, Jorm C, Grattan Institute. All complications should count: using our data to make hospitals safer. 2018.
- Partridge JSL, Harari D, Martin FC, Peacock JL, Bell R, Mohammed A, et al. Randomized clinical trial of comprehensive geriatric assessment and optimization in vascular surgery. *Br J Surg*. 2017 May;104(6):679–87.
- Barberan-Garcia A, Ubré M, Roca J, Lacy AM, Burgos F, Risco R, et al. Personalised Prehabilitation in High-risk Patients Undergoing Elective Major Abdominal Surgery: A Randomized Blinded Controlled Trial. *Ann Surg*. 2018 Jan;267(1):50–6.
- Carli F, Bousquet-Dion G, Awasthi R, Elsherbini N, Liberman S, Boutros M, et al. Effect of Multimodal Prehabilitation vs Postoperative Rehabilitation on 30-Day Postoperative Complications for Frail Patients Undergoing Resection of Colorectal Cancer: A Randomized Clinical Trial. *JAMA Surg*. 2020 Mar 1;155(3):233–42.
- Effectiveness and cost-effectiveness of INSPIRatory muscle training (IMT) for reducing postoperative pulmonary complications (PPC): a sham-controlled randomised controlled trial (RCT) (INSPIRE) - Grant details - Europe PMC [Internet]. [cited 2021 Apr 23]. Available from: <https://europepmc.org/grantfinder/ntdetails?query=pi%3A%22Pufulete%2BM%22%2Bgid%3A%2216%2F140%2F07%22%2Bg%3A%22National%20Institute%20for%20Health%20Research%20%28Department%20of%20Health%29%22>
- University Hospital Southampton NHS Foundation Trust. A Pragmatic Factorial Design Randomised Controlled Study to Assess the Efficacy of the Implementation of a Prehabilitation Programme in Patients Undergoing Elective Major Intra-Cavity Cancer Surgery in Wessex [Internet]. *clinicaltrials.gov*; 2019 May [cited 2021 Apr 21]. Report No.: NCT03509428. Available from: <https://clinicaltrials.gov/ct2/show/NCT03509428>
- Story DA, Leslie K, Myles PS, Fink M, Poustie SJ, Forbes A, et al. Complications and mortality in older surgical patients in Australia and New Zealand (the REASON study): a multicentre, prospective, observational study. *Anaesthesia*. 2010 Oct;65(10):1022–30.
- Payment by Results in the NHS: a simple guide [Internet]. GOV.UK. [cited 2020 Sep 6]. Available from: <https://www.gov.uk/government/publications/simple-guide-to-payment-by-results>
- Hicks P, Huckson S, Fenney E, Leggett I, Pilcher D, Litton E. The financial cost of intensive care in Australia: a multicentre registry study. *Med J Aust*. 2019 Sep 9;211(7):324–5.
- Swart M, Carlisle JB, Goddard J. Using predicted 30 day mortality to plan postoperative colorectal surgery care: a cohort study. *Br J Anaesth*. 2017 Jan 1;118(1):100–4.
- Wong DJN, Harris SK, Moonesinghe SR, Moonesinghe SR, Wong DJN, Harris SK, et al. Cancelled operations: a 7-day cohort study of planned adult inpatient surgery in 245 UK National Health Service hospitals. *Br J Anaesth*. 2018 Oct 1;121(4):730–8.
- Ahmad T, Bouwman RA, Grigoras I, Aldecoa C, Hofer C, Hoeft A, et al. Use of failure-to-rescue to identify international variation in postoperative care in low-, middle- and high-income countries: a 7-day cohort study of elective surgery. *Br J Anaesth*. 2017 Aug 1;119(2):258–66.
- Abbott TEF, Fowler AJ, Dobbs TD, Harrison EM, Gillies MA, Pearse RM. Frequency of surgical treatment and related hospital procedures in the UK: a national ecological study using hospital episode statistics. *BJA Br J Anaesth*. 2017 Aug 1;119(2):249–57.

28. Wong DJN, Harris S, Sahni A, Bedford JR, Cortes L, Shawyer R, et al. Developing and validating subjective and objective risk-assessment measures for predicting mortality after major surgery: An international prospective cohort study. *PLOS Med.* 2020 Oct 15;17(10):e1003253.
29. Wong DJN, Popham S, Wilson AM, Barneto LM, Lindsay HA, Farmer L, et al. Postoperative critical care and high-acuity care provision in the United Kingdom, Australia, and New Zealand. *Br J Anaesth.* 2019 Apr;122(4):460–9.
30. Pearse RM, Moreno RP, Bauer P, Pelosi P, Metnitz P, Spies C, et al. Mortality after surgery in Europe: a 7 day cohort study. *Lancet Lond Engl.* 2012 Sep 22;380(9847):1059–65.
31. Turan A, Mascha EJ, Roberman D, Turner PL, You J, Kurz A, et al. Smoking and perioperative outcomes. *Anesthesiology.* 2011 Apr;114(4):837–46.
32. Villebro NM, Pedersen T, Møller AM, Tønnesen H. Long-term effects of a preoperative smoking cessation programme. *Clin Respir J.* 2008 Jul;2(3):175–82.
33. Wong J, Abrishami A, Yang Y, Zaki A, Friedman Z, Selby P, et al. A perioperative smoking cessation intervention with varenicline: a double-blind, randomized, placebo-controlled trial. *Anesthesiology.* 2012 Oct;117(4):755–64.
34. Whetton S, Tait RJ, Scollo M, Banks E, Chapman J, Dey T, et al. Identifying the social costs of tobacco use to Australia in 2015/16 [Internet]. Perth, WA: National Drug Research Institute, Curtin University; 2019 [cited 2021 Jun 6]. Available from: <http://ndri.curtin.edu.au/NDRI/media/documents/publications/T273.pdf>
35. Lozada MJ, Nguyen JTC, Abouleish A, Prough D, Przkora R. Patient preference for the pre-anesthesia evaluation: Telephone versus in-office assessment. *J Clin Anesth.* 2016 Jun;31:145–8.
36. Mihalj M, Carrel T, Gregoric ID, Andereggen L, Zinn PO, Doll D, et al. Telemedicine for preoperative assessment during a COVID-19 pandemic: Recommendations for clinical care. *Best Pract Res Clin Anaesthesiol.* 2020 Jun;34(2):345–51.
37. Irizarry-Alvarado JM, Lundy M, McKinney B, Ray FA, Reynolds VE, Pai S-L. Preoperative Evaluation Clinic Redesign: An Initiative to Improve Access, Efficiency, and Staff Satisfaction. *Am J Med Qual Off J Am Coll Med Qual.* 2019 Aug;34(4):348–53.
38. Haddad N, Paranjpe R, Rizk E, Basit SA, McNamara C, Okoro E, et al. Value of pharmacy services in an outpatient, preoperative, anesthesia clinic. *J Am Pharm Assoc JAPhA.* 2020 Apr 14;
39. Marotti SB, Kerridge RK, Grimer MD. A randomised controlled trial of pharmacist medication histories and supplementary prescribing on medication errors in postoperative medications. *Anaesth Intensive Care.* 2011 Nov;39(6):1064–70.
40. Kinley H, Czoski-Murray C, George S, McCabe C, Primrose J, Reilly C, et al. Extended scope of nursing practice: a multicentre randomised controlled trial of appropriately trained nurses and pre-registration house officers in pre-operative assessment in elective general surgery. *Health Technol Assess Winch Engl.* 2001;5(20):1–87.
41. Greenberg J. Over-testing: Why More Is Not Better. :2.
42. National Guideline Centre (UK). Preoperative Tests (Update): Routine Preoperative Tests for Elective Surgery [Internet]. London: National Institute for Health and Care Excellence (UK); 2016 [cited 2020 Sep 13]. (National Institute for Health and Care Excellence: Clinical Guidelines). Available from: <http://www.ncbi.nlm.nih.gov/books/NBK355755/>
43. Leung BC, Nazeer S, Smith M, McRae D. Reducing Unnecessary Preoperative Testing in Elective Ent Surgery: Clinical and Financial Implications: *J Perioper Pract* [Internet]. 2015 Nov 1 [cited 2020 Sep 13]; Available from: <https://journals.sagepub.com/doi/10.1177/175045891502501103>
44. Wilson A, Ronnekleiv-Kelly SM, Pawlik TM. Regret in Surgical Decision Making: A Systematic Review of Patient and Physician Perspectives. *World J Surg.* 2017;41(6):1454–65.
45. The IHI Triple Aim | IHI - Institute for Healthcare Improvement [Internet]. [cited 2020 Aug 30]. Available from: <http://www.ihio.org:80/Engage/Initiatives/TripleAim/Pages/default.aspx>
46. Harnett MJP, Correll DJ, Hurwitz S, Bader AM, Hepner DL. Improving Efficiency and Patient Satisfaction in a Tertiary Teaching Hospital Preoperative Clinic. *Anesthesiology.* 2010 Jan 1;112(1):66–72.
47. Pakdil F, Harwood TN. Patient satisfaction in a preoperative assessment clinic: an analysis using SERVQUAL dimensions. *Total Qual Manag Bus Excell.* 2005 Jan 1;16(1):15–30.
48. Ortiz J, Wang S, Elayda MA, Tolpin DA. Preoperative patient education: can we improve satisfaction and reduce anxiety? *Braz J Anesthesiol Engl Ed.* 2015 Jan 1;65(1):7–13.
49. Health literacy [Internet]. Australian Institute of Health and Welfare. [cited 2021 Jun 2]. Available from: <https://www.aihw.gov.au/reports/australias-health/health-literacy>
50. Grocott MPW, Plumb JOM, Edwards M, Fecher-Jones I, Levett DZH. Re-designing the pathway to surgery: better care and added value. *Perioper Med.* 2017 Jun 20;6(1):9.
51. Moonesinghe SR, Jackson AIR, Boney O, Stevenson N, Chan MTV, Cook TM, et al. Systematic review and consensus definitions for the Standardised Endpoints in Perioperative Medicine initiative: patient-centred outcomes. *Br J Anaesth.* 2019 Nov 1;123(5):664–70.

## Use of mobile applications in perioperative medicine

### Josh Szental MBBS (Hons) MMed FANZCA

#### Western Health, Melbourne, Australia

Dr Josh Szental is a staff anaesthetist, perioperative medicine specialist and amateur programmer. He has a keen interest in perioperative medicine and the use of technology to make healthcare more efficient and safe. Josh is the current perioperative lead and a safety and quality officer in the Department of Anaesthesia, Pain and Perioperative Medicine at Western Health, Melbourne.

### Rani Chahal MBBS FANZCA

#### The Peter MacCallum Cancer Centre, Melbourne, Australia

Dr Rani Chahal is a clinical and research staff anaesthetist at the Peter MacCallum Cancer Centre and a senior clinical lecturer at the University of Melbourne. Rani has a strong interest in perioperative medicine, quality improvement and implementation science and is the current quality officer and airway lead at the Department of Cancer Anaesthesia, Perioperative and Pain Medicine. His research themes include prevention of postoperative haematological and pulmonary complications, patient education through virtual platforms and implementation science using technological aids. Rani was awarded the Peter Mac Team Excellence Award in 2014, the Victorian Premier's Healthcare Award for Excellence in Cancer Care in 2015 and the ANZCA Gilbert Brown Prize in 2018 for his work on surgical thromboembolism prevention.

### Gregg Miller MBChB (Hons) FANZCA

#### Western Health, Melbourne, Australia

Dr Gregg Miller has completed fellowships in simulation, airway management and obstetrics in the UK. He is a staff anaesthetist at Western Health, Melbourne. He is the patient blood management lead, with a particular interest in viscoelastic point of care testing. Gregg shares an interest in the use of technological aids as clinical decision support tools.

## INTRODUCTION

Perioperative medicine is a broad and expanding field of medicine. Multiple groups of clinicians are involved with patient care from the time of contemplation of surgery until recovery is complete. Despite the widespread availability of major international guidelines and electronic clinical decision-support tools, it is difficult for clinicians to keep abreast of the rapidly expanding evidence base and latest recommendations. In addition, effective communication and dissemination of information between the profession and clinicians, and between clinicians and patients, is an ongoing challenge. Mobile applications are a novel and increasingly available solution to these problems, which is acceptable to end users and provides clinicians and developers with enormous flexibility to innovate.

## DISSEMINATION OF INFORMATION

In 1962, Everett Rogers described the diffusion of innovations theory<sup>1</sup>, which outlined how, why, and at what rate, the uptake of new innovations spread through a population. This model can also be applied to the diffusion of evidence-based practice<sup>2</sup> in perioperative medicine. The factors that determine whether, and how rapidly, new evidence is adopted were outlined by Rogers. They include:

1. Relative advantage – the greater the benefit of a novel practice on the patient risk profile, the clinician and/or an organisation, the greater the likelihood of adoption. For example, the Evaluation of nitrous oxide in the gas mixture for anaesthesia (ENIGMA) trial<sup>3</sup> reported a significant reduction in major complications (OR 0.71) when nitrous oxide was avoided in major surgery. This led to a rapid, though temporary, reduction in the use of nitrous oxide across Australasia.
2. Compatibility – the degree to which new evidence is compatible with clinicians' existing beliefs and past experiences. For example, the Preoperative intravenous iron to treat anaemia before major abdominal surgery (PREVENTT) trial<sup>4</sup> found that preoperative iron infusion was not associated with a reduction in blood transfusion rates in anaemic patients undergoing major abdominal surgery. This finding was not compatible with most clinicians' beliefs about the benefits of preoperative iron therapy, which has impacted the adoption of these findings.
3. Complexity – evidence perceived as more complex to understand or implement is less likely to be rapidly adopted. For example, the Measurement of exercise tolerance before surgery (METS) study<sup>5</sup> reported that the use of the Duke Activity Status Index (DASI) questionnaire was superior to subjective assessment

of functional capacity in predicting postoperative mortality or myocardial infarction within 30 days after surgery. However, the perceived complexity of administering the DASI questionnaire has slowed the implementation of this tool.

4. Trialability – the degree to which evidence can be trialled in real-world practice before a full-scale rollout can impact its uptake. For example, findings from Mangano et al<sup>6</sup> of a significant reduction in postoperative mortality when atenolol was prescribed in high-risk patients was a simple intervention with a perceived benefit that clinicians could apply and trial in the preoperative period. This improved its early adoption despite subsequent evidence to the contrary, in the Perioperative ischemic evaluation (POISE) trial<sup>7</sup>.
5. Observability – a change to practice that provides perceived benefit, and is visible to colleagues, is more likely to be rapidly adopted. Clinicians are able to observe the relative advantage of a change in practice before implementing it themselves. The strong influence of respected colleagues embracing a change to practice also drives the adoption of visible innovations. An example is the introduction of the Bispectral index (BIS) monitor which, through observability amongst colleagues, helped accelerate its introduction into clinical practice.

While changes to practice that are significantly beneficial, consistent with our prior beliefs, simple, triable in our own practice and observable by others will be rapidly adopted, how can we encourage adoption of the myriad of smaller evidence-based findings that collectively provide significant value to patients?

There is a need for tools to help distill an increasingly complex and rapidly changing evidence base and enable decision support at the point of care. This is particularly important for complex decision-making and decisions that are made infrequently.

Local hospital procedures and guidelines are commonly used to provide evidence-based guidance for clinicians. Over and above the benefits of following national or international guidelines, local guidelines allow specification based on clinical setting, clinician preferences, and patient population. For example, the 2014 American College of Cardiology/American Heart Association Guideline on Perioperative Cardiovascular Evaluation and Management of Patient Undergoing Noncardiac Surgery<sup>8</sup> recommend that “Management of the perioperative antiplatelet therapy should be determined by a consensus of the surgeon, anesthesiologist, cardiologist, and patient, who should weigh the relative risk of bleeding with that of stent thrombosis.” The risk of surgical bleeding, and the risk of stent thrombosis are often difficult for clinicians to accurately predict. Different clinicians may have different perceptions of risk. A local guideline can allow local agreement about acceptable levels of risk to improve the efficiency and consistency of advice given.

Guidelines are often difficult to access at the point of care in a timely fashion. Printed guidelines run the risk of being outdated when new evidence emerges, and electronic guidelines require access to a computer. Even though guidelines can be accessed on a smartphone, the format of a written guideline requires the clinician to read through the guideline and make an informed decision about patient care that is targeted towards the individual. The emergence of novel and readily available technologies such as smartphone applications (apps) may address these problems by providing a modern solution to information dissemination.

## MOBILE DEVICE APPS

In July 2008, Apple Inc (Cupertino, CA, USA) launched the App Store and with it, the app revolution. This opened up a competitive landscape where software development companies could create increasingly complex mobile apps. As devices such as the smartphone have matured, and new devices such as the tablet and smartwatch have been developed, programming languages have also evolved. Whereas in the past, a software development company needed to code multiple versions of a single app for use on different platforms such as Apple iOS, Google Android, and web, some programming languages now allow a single set of code to be deployed across multiple platforms simultaneously. This has drastically reduced the time and cost of developing an app, as well as the skill sets required to do so.

The mobile platform provides particular benefits in the healthcare setting as it enables software to be used at the point of care. Even with the proliferation of desktop computers and tablets throughout hospital networks in order to facilitate the use of electronic medical records (EMR) by clinicians at the bedside, many clinicians still prefer to access software on their personal devices where it is appropriate to do so, due to the speed and ease of access.

Mobile apps for use in the healthcare setting are abundant, of varying quality, and are created for a wide range of uses. These can broadly be categorised as:

1. Patient-facing apps – for health promotion, data entry, or behaviour modification. For example, an app that instructs a patient in prehabilitation prior to major surgery.

2. Hospital-facing apps – for reporting, benchmarking and maintaining standards. For example, an app that allows compliance with Enhanced Recovery After Surgery protocols to be monitored.
3. Clinician-facing apps – for educational purposes, communication, decision support, accessing medical records and documentation.

This article will focus on clinician-facing mobile apps and provide a narrative review of their development, application and limitations.

## CLINICAL DECISION SUPPORT SYSTEMS

Clinical decision support systems (CDSS) are a type of clinician-facing app and have been used in clinical medicine since the 1970s. CDSS are typically pieces of software that aid clinicians by matching individual patient data to a clinical knowledgebase resulting in a recommendation to the clinician<sup>9</sup>. As computers have evolved, CDSS have become increasingly abundant, specific and integrated. Most EMR now include varying levels of decision support using patient data, and increasingly, machine learning and artificial intelligence are being trialled within CDSS algorithms in an effort to improve clinical decision making beyond that of a flow diagram or simple algorithm.

CDSS have also been developed outside of EMR to support clinicians at the point of care, platformed on mobile devices, websites or computers.

There are a number of benefits and concomitant risks with CDSS<sup>9</sup>:

1. Patient safety – CDSS can reduce the number of errors particularly in prescribing but can be associated with alert fatigue when integrated into EMR prescribing.
2. Clinical management – CDSS increase adherence to guidelines but run the risk of blind user adherence due to excessive trust in the system.
3. Cost containment – by reducing ordering of unnecessary tests, suggesting cheaper but equally efficacious treatment options, and by improving time efficiency.
4. Automation – CDSS may be able to automate tasks such as documentation of clinical decisions which can improve efficiency and clarity of medical records, particularly when directly integrated with EMR.

### Simplifying complexity

“Simplicity is hard to build, easy to use, and hard to charge for. Complexity is easy to build, hard to use, and easy to charge for.” – Chris Sacca, American venture investor

Before embarking on the development of a mobile app, it is important to consider the complexity of the information or decision-making algorithm, and where the app will be used. Certain decision support algorithms and settings lend themselves well to mobile apps. These include:

1. Complex algorithms – algorithms with “tree-like” structures of decision nodes, or where decision nodes can dynamically change based on previous answers are especially feasible for mobile apps.
2. Multiple inputs – decision nodes that require multiple inputs to determine the best course of action, for example, calculation of creatinine clearance or determination of a risk score, are more intuitive and easier to use when presented as a mobile app.
3. Settings with no time pressure – mobile apps require handling of a mobile phone and may take some time to open and operate which makes algorithms used in time pressured settings less likely to be advantageous.

For example, the Vortex approach to airway management<sup>10</sup> is a simple algorithm, does not require interactivity during its use, and is typically used in emergency settings. This type of algorithm is better suited to a poster format.

Complex algorithms are prone to misinterpretation and misuse when displayed in paper format. They often contain exceptions to the rule, specific exclusions, duplicate pathways and false polychotomies. Complex algorithms lend themselves very well to mobile apps which allow the user to be stepped through a dynamic series of questions, each of which can be changed depending on the previous answer. This reduces the risk of incorrect advice being obtained by the user.

It is important that any guideline, but particularly a guideline that will be converted for use in a mobile app, undergo a process of simplification to eliminate complexity as much as possible. It is often surprising how much a complex series of decision nodes can be streamlined, and it makes the task of programming the algorithm's logic much simpler.

Below, we describe the development process of a mobile app, and then provide narrative reviews of three mobile apps that were used to provide decision support for complex algorithms.

## THE DEVELOPMENT PROCESS OF A MOBILE APP

There are a number of steps and decisions that need to be negotiated in the development of point-of-care mobile apps. These include:

### Purpose

Determine the purpose and scope of the proposed app. Will the app be used to make local, national or international guidelines easier to use? Will the app be used to store patient information or relay that information to a hospital server? Decide at this early stage whether an app is the most appropriate medium for the idea.

### Intended end-users

The intended end-users should be identified in the context of the intended use of the app. This may be a general-purpose app for national or international distribution, or a local app developed specifically for the hospital or network.

### Platform

Decide on the platform(s) on which the app will run. Apps for personal devices will require development on multiple operating systems to account for the variety of mobile operating systems available. Alternatively, apps designed to run on dedicated, hospital devices may only require development for one operating system.

There are a number of advantages and disadvantages to hosting apps on various platforms, even though all platforms can be accessed on a mobile device with internet connectivity (see Table 1).

**Table 1. Advantages and disadvantages of hosting an app on various platforms**

Platform	Advantages	Disadvantages
Hospital intranet	<ul style="list-style-type: none"> <li>Secure environment</li> <li>Visible to hospital administration</li> <li>Directly linked to the “source of truth” so it is never outdated</li> <li>May be more easily linked to Electronic Medical Record</li> <li>Will run on all operating systems</li> </ul>	<ul style="list-style-type: none"> <li>Not portable for use in other hospitals</li> <li>Requires login details</li> <li>May have limited interactivity or programmability</li> </ul>
Web	<ul style="list-style-type: none"> <li>Available for use anywhere</li> <li>Will run on all operating systems</li> <li>Guarantees user is accessing the latest version</li> </ul>	<ul style="list-style-type: none"> <li>Internet access required for use</li> <li>Both a desktop and mobile version may be needed for usability</li> <li>May require login details if the app is not for public use</li> </ul>
Mobile app	<ul style="list-style-type: none"> <li>Available for use anywhere</li> <li>Available for use without internet connectivity</li> </ul>	<ul style="list-style-type: none"> <li>Operating system specific</li> <li>Need to ensure user is using the latest version of app</li> </ul>

### Developers, timeline and cost

Developer options include outsourcing the entire development process to an external software development company, developing the app in-house, or a hybrid model. There are several advantages and disadvantages to each.

Outsourcing the development to a software development company can be advantageous for several reasons. A professional app developer is likely to be able to turn around an app in a short timeframe, the final product is likely to look and feel more professional than in-house design, and advanced features such as electronic health record integration, safekeeping of patient data, and analytics will be easier to implement. Disadvantages of using a software development company are cost, lack of control for frequent iteration and the need for ongoing funding when an app requires updating. The cost for outsourcing app development is generally \$A10-20,000 for a basic app, to upwards of \$A200,000 for a complex app<sup>11</sup>.

Developing an app in-house is feasible. Advantages of in-house development include full creative control, the ability to iterate many times over to develop an app that is exactly fit for purpose and low to no cost. Disadvantages include the use of valuable staff time to learn and refine programming skills, slower time frames for app completion, and the potential for major coding errors if testing is not undertaken diligently.

Learning to program in a number of programming languages is now possible due to the presence of a number of reputable online course providers. The leading languages for cross-platform app development are Xamarin (developed by Xamarin in 2013, now owned by Microsoft, based on the C# programming language), React Native (developed by Facebook in 2015, based on the Javascript programming language), and Flutter (developed by Google in 2018, based on the Dart programming language). All of these languages enable fast, cross-platform development, one set of code for distribution to multiple operating systems and platforms simultaneously such as iOS, Android, and web, and a strong focus on creating intuitive user interfaces.

### Develop a network to assist with development

A collaborative team approach is an essential ingredient in app development. Depending on the content of the app, a multidisciplinary team may provide insights that will improve the functionality and usability of the app. It is important to engage with representatives of the end-user group, and consumer advocates may also be helpful if the app has a patient-facing component.

Executive sponsorship and buy in is also valuable to ensure that the healthcare network provides both financial and non-financial support. This ensures that the objectives of the app are met and are aligned with other initiatives, and existing policies and procedures.

Terms and conditions, disclaimer and privacy statements should be clearly set out. Legal advice should be sought to ensure the hospital, clinicians and developers are protected from legal liability resulting from decision support provided by the app. Enquiries should also be made to assess if any part of the app might require intellectual property protection.

### Planning

Regardless of which development pathway is selected, the planning stage for an app is critical. The front end (user interface and user experience – UI/UX) and back end (coding) should be planned in advance, particularly when an app's development is outsourced.

### Front end

The user interface is the public face of any app. Hospital logo, colour scheme and/or specific hospital information may be included here. It is sensible to obtain authorisation for any hospital branding from the hospital executive, public affairs and the legal department before development begins. Drawing out what a user interface might look like is helpful to save time.

### Back end

Clear decision support algorithms are important to allow programmers to code flowcharts and guidelines accurately. Computers and non-medical programmers do not have the ability to interpret medical information to create accurate decision trees, so this process must be thoroughly documented and account for all possibilities. When designing the back end, developers should think about potential pitfalls or unexpected user inputs that may impact the decision tree and result in incorrect recommendations.

The process of converting a guideline or flowchart into logical statements that can be used for programming is a useful process in and of itself. Often, complex algorithms can be simplified significantly by determining the key decision nodes that make paper-based guidelines and algorithms easier to understand and apply without the use of mobile apps.

A decision needs to be made on whether the app will interface with external databases, apps or the electronic health record. This increases the complexity of the app and introduces issues with data storage and security. The addition of data analytics allows developers to evaluate how the app is being used by the target population.



## Getting started

App development should be an iterative process that allows incremental improvements over time. Regular reviews of progress should be undertaken to ensure app development is proceeding in the right direction. The use of early end-user feedback on each prototype is critical to ensure that the app is delivering on its intended objectives and to reduce the risk of the project veering off track.

## Beta testing

The app should be tested with the target user group to ensure that it is fit for purpose and does not contain coding errors. It is important to conduct a separate set of testing for each platform to exclude any platform-specific errors.

Any app module that replicates an existing guideline or process should be rigorously tested by users not involved in the app development to ensure the decision-support tools give appropriate recommendations.

## Governance

A governance framework should be developed to decide on the “source of truth” for guidelines, to outline the process for ensuring that the app is up to date, and to ensure that future updates are not reliant on a single individual.

## Publication

Following the above steps, the app should be published and distributed on all intended platforms. This should be advertised to intended user groups in order to promote uptake. Engaging “thought leaders” early may improve the app’s observability by other clinicians.

## Closing the loop

Feedback should be sought on the performance of the app and developers should reflect on whether the app has fulfilled its intended purpose. Improvements or modifications should be considered soon after release if issues arise. This continuous improvement process ensures that the app remains a valued and useful resource for end-users and facilitates future updates.

## NARRATIVE REVIEWS

### Perioperative management of antiplatelet medications and anticoagulants

The management of antiplatelet medications and anticoagulants in the perioperative period represents a complex clinical scenario that can result in devastating complications for patients if managed inappropriately. Despite the development of international guidelines to address this issue, the management of these agents remained an especially challenging area for staff to navigate at Western Health in Melbourne, Victoria. Junior doctors frequently contacted their surgical seniors to ask for advice about the perioperative cessation of these agents, and often needed to contact cardiology or haematology for medication advice. This created an additional workload for staff and resulted in inconsistent advice. Heterogeneity in advice given by individual clinicians for the same procedure often resulted in junior medical staff withholding medications unnecessarily for fear of causing day of surgery cancellation. This was clearly not in the best interests of the patients or the hospital network.

To address this, a local guideline was developed at Western Health. Each surgical unit was asked to provide a consensus statement about medication management for each type of surgical procedure. This process led to the development of a comprehensive, yet complex guideline. To further simplify these guidelines, each surgical procedure was categorised into a number of distinct groups that informed medication management resulting in a less complex algorithm.

To further assist staff at the network, clinicians in the Department of Anaesthesia, Pain and Perioperative Medicine developed a perioperative guidelines app that included a module for the management of antiplatelet medications and oral anticoagulants. Development of the app was done in-house using Flutter. This allowed one set of code to be deployed on both iOS and Android devices simultaneously and enabled more rapid updating. A governance process was developed to ensure the app was up to date with existing hospital guidelines.

The final app module contained a medication selection screen, together with seven decision nodes dynamically presented to users based on previous input information in order to help the app make a recommendation on medication management. This resulted in a smooth user experience which enabled medication advice to be obtained rapidly (see Figure 1). The app underwent extensive testing by a number of junior and senior medical staff prior to its release.

Due to the inclusion of hospital-specific information, the app is currently an enterprise-level app only available for download by staff through the intranet, and not available for wider purchase on the App Store (iOS) or Google Play Store (Android).

**Figure 1. Screenshots showing example advice in the Perioperative Management of Antiplatelet Medication and Oral Anticoagulants mobile app module**

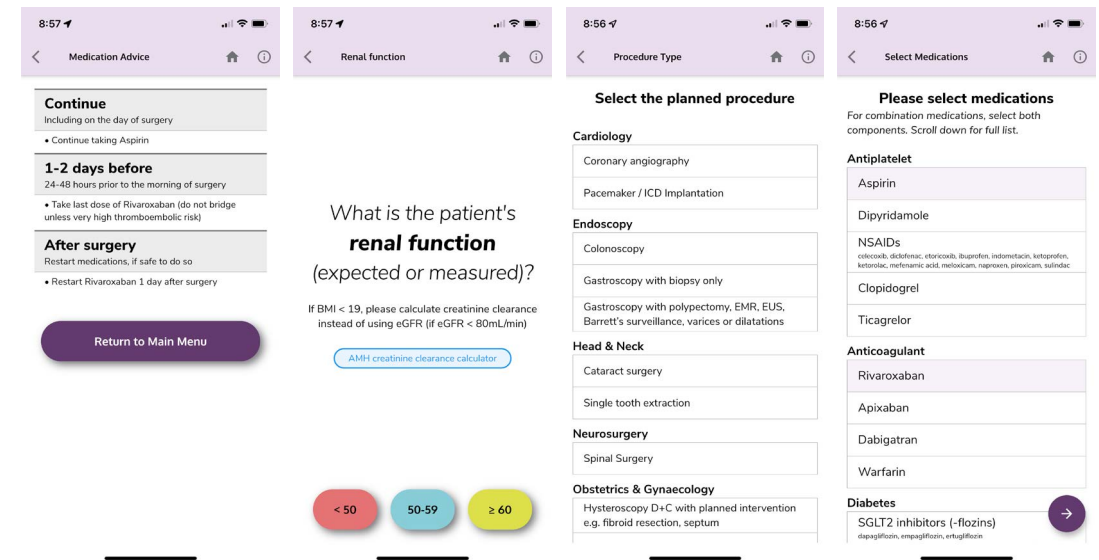

## ROTEM® interpretation

A module was developed within the Western Health perioperative guidelines app to assist with interpretation of point-of-care viscoelastic haemostatic assay (POC VHA) results to guide blood product transfusion. This decision support tool aimed to assist with two major changes to management of major obstetric haemorrhage at the institution: the introduction of Rotational Thromboelastometry (ROTEM®) and of fibrinogen concentrate.

Western Health adopted a ROTEM® algorithm from another hospital (see Figure 2). This algorithm provided guidance on blood product interventions based on ROTEM® results. However, it suffered from duplicate pathways that could lead users to assume an incorrect cause for the bleeding diathesis and provide an incorrect intervention. Compounding this, navigation of this decision tree usually occurred during a time-critical emergency of a major obstetric haemorrhage, when clinical staff are cognitively overloaded. Additionally, in a large department, staff may not perform and interpret a ROTEM® for several months. The potential for skill fade and staff unfamiliarity has been recognised as a barrier to safe adoption and usage of POC VHA testing<sup>12</sup>.

**Figure 2. Western Health ROTEM® algorithm and guide to fibrinogen concentrate dosing for obstetric critical bleeding (adapted with permission from King Edward Memorial Hospital Perth, Australia)**

Western Health ROTEM Algorithm for Obstetric Critical Bleeding (Adapted with permission from King Edward Memorial Hospital, Perth, Australia, V2 31/05/2017)					
For the management of obstetric bleeding (bleeding in the 2 <sup>nd</sup> and 3 <sup>rd</sup> trimester) Only treat abnormal values if active bleeding or at high risk of bleeding. Avoid hypothermia, hypocalcaemia, acidosis, severe anaemia.					
	ABNORMAL ROTEM	CRITERIA	DIAGNOSIS	INTERVENTION	CORRECTED ROTEM
FIBRINOGEN		FIBTEM A5 ≤10mm	Low fibrinogen	Cryoprecipitate OR Fibrinogen concentrate (see dosing guide) AND Tranexamic acid 1g	
		EXTEM A5 ≤35mm and FIBTEM A5 ≥10mm	Low platelets	Platelets: 1 adult dose (correlate with platelet count)	
PLATELETS		EXTEM A5 ≤25mm and FIBTEM A5 ≤10mm	Low platelets and Low fibrinogen	Platelets and Fibrinogen (correlate with platelet count)	
		EXTEM CT 80-140s and FIBTEM A5 ≤10mm	Low fibrinogen	Correct fibrinogen and reassess	
FACTORS		EXTEM CT >140s and FIBTEM A5 ≤10mm	Low fibrinogen and Low coagulation factors	FFP 1-2U + Fibrinogen as indicated (Consider Prothrombinex-VF)	
		Early Diagnosis EXTEM A5 ≤35mm or FIBTEM CT >600s	High likelihood of excess fibrinolysis	Tranexamic acid 1g Consider repeat dose if has lost over 1 blood volume since initial dose	
FIBRINOLYSIS		Late Diagnosis EXTEM or FIBTEM ML ≥5%	Excess fibrinolysis		

Repeat ROTEM analysis 10 mins after intervention to assess response.

Fibrinogen Dosing Guide			
FIBTEM A5 Target: ≥12mm			
FIBTEM A5	Increase required	Cryoprecipitate (WB-whole blood, Aa apheresis)	Fibrinogen Concentrate
9-10mm	2-3 mm	10 – 20 WB units or 5-10 A units	2g
7-8mm	4-5 mm	10 – 20 WB units or 5-10 A units	3g
4-6mm	6-8 mm	20 WB units or 10 A units	4g
<4mm	≥9mm	20 WB units or 10 A units	5g

Fibrinogen Concentrate	
Guidelines for Use	
<ul style="list-style-type: none"> <li>Consultant anaesthetist approval required.</li> <li>Fibrinogen concentrate may be given when FIBTEM A5 ≤ 10mm and cryoprecipitate is not immediately available.</li> <li>This dose of Fibrinogen Concentrate should be guided by the "Fibrinogen Dosing Guide".</li> <li>When Fibrinogen Concentrate is used, cryoprecipitate should be ordered in preparation for subsequent dosing.</li> <li>If ROTEM is not available, fibrinogen concentrate may be given when there is a high suspicion of coagulopathy in a life-threatening haemorrhage.</li> </ul>	
Administration	
<ul style="list-style-type: none"> <li>Reconstitute 1g in 50ml warm sterile water (use prepared kit in fluid warmer).</li> <li>Swirl gently and do not shake (to avoid foaming). After reconstitution, the RiaSTAP solution should be colourless and clear to slightly opalescent.</li> <li>Administer each 1g over 2-4 mins if life-threatening haemorrhage or over 10mins if not.</li> </ul>	

After an informal needs assessment by senior clinicians involved in patient blood management, ROTEM® training and quality control, it was decided that a novel solution would be to create a clinical decision support tool via a mobile app. A process of algorithm simplification was undertaken where the decision nodes were ordered in such a way to allow sequential logic to determine which products to use, eliminating duplicate pathways. This resulted in a simple flow diagram that could be used for programming.

The ROTEM® module was developed into the perioperative app by using the same programming software described in the previous section. Once the "backend" logic of the algorithm had been programmed, different user interfaces were trialled prior to choosing the most practical one. The input and output screens from the current iteration are shown in Figure 3. The input screen requires the user to select the patient demographic data plus three ROTEM® parameters used to populate the output screen providing the user with the recommended interventions.

Testing was performed using 22 abnormal ROTEM® results from real cases from an online bank<sup>13</sup>. The interpretation and treatment suggested by the support tool were reviewed by two senior clinicians with experience in ROTEM® to confirm the validity of the backend logic and provide feedback on the user journey. Ongoing improvements for future iterations continue to be guided by clinician feedback.

**Figure 3. Screenshots showing an example of input screen (left) for obstetric patient with a low FIBTEM A5 suggestive of hypofibrinogenaemia and output screen (right) recommendations, including fibrinogen concentrate dosing**

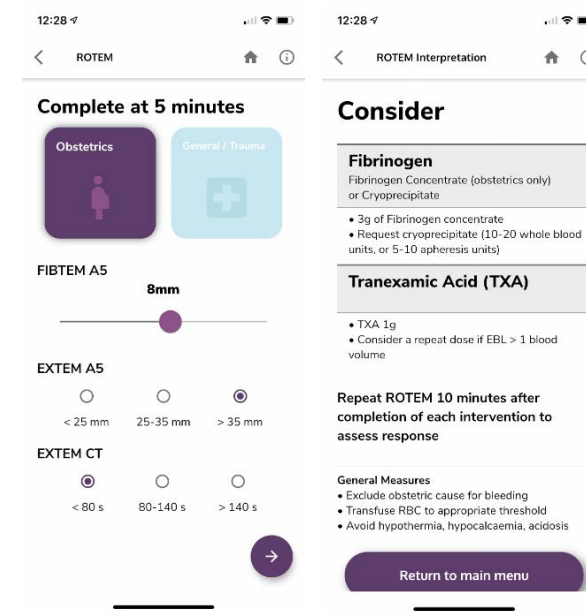

### Consultations on haematoLogical Optimisation and Thrombosis in Surgery (CLOTS) app

A module on Surgical Thrombo-Embolism Prevention (STEP) was developed by a group of perioperative medicine clinicians as part of a cross-platform decision support app CLOTS – Consultations on haematoLogical Optimisation and Thrombosis in Surgery (see Figure 4). The CLOTS app aimed to reduce postoperative haematological complications such as venous thromboembolism (VTE) and bleeding, as well as to improve the preoperative optimisation of patients presenting for surgery at the Peter MacCallum Cancer Centre, a dedicated cancer hospital in Melbourne, Victoria.

The impetus for the STEP module was an audit conducted on VTE prophylaxis, which revealed significant heterogeneity in VTE risk assessment and underutilisation of both mechanical and pharmacological thromboprophylaxis<sup>14</sup>.

As part of a four-stage quality improvement initiative to reduce the rate of postoperative VTE, a novel risk-stratified algorithm, the STEP protocol, was developed. However, multiple barriers to successful implementation were encountered, including the need for frequent staff re-education to account for high staff turnover, human error in protocol interpretation and adherence to risk-level specific recommendations. As a result, the STEP decision support tool, was developed to address barriers to improvements achieved with the initial implementation stage of the program.

The app was built by a software development company (gSoft production media®) with close supervision from the project's clinical leads. Development of the app relied on co-design documents and flowcharts that mapped the underlying algorithms and outlined predictive models, calculation functions and decision-rules needed to build the backend logic of the app. Extensive iterative testing of the app was performed and compared against the master to ensure that the provided recommendations were accurate. Adjustments and refinements were made to ensure reliability and usability, and to improve the user experience. Funding for app development was obtained from a generous donation from the hospital's auxiliary service staff and the app was made freely available to in-house staff as well as to a broader audience through online app stores.

The CLOTS app was embedded into the workflow of perioperative staff. Day of surgery nursing staff were provided with a tablet running CLOTS that allowed them to perform a VTE risk assessment on all patients presenting for surgery. The STEP module generated risk-level appropriate thromboprophylaxis recommendations. The risk profile and recommendations were then printed and provided for review by medical staff at the World Health Organization surgical time-out. The STEP module, together with the nurse-initiated risk assessment program, were key interventions that drove sustained quality improvement.

Other modules were used by pre-anaesthetic clinic medical and nursing staff and pharmacists to guide decisions about haematinic optimisation and perioperative management of haemostatic altering drugs. These recommendations provided by various modules were based on local policies and published studies<sup>15</sup>. The clinicians are currently evaluating the feasibility of integrating the four CLOTS app modules into their EMR in order to assess the frequency of clinician use of the app, clinician behaviour and monitor the accuracy of adherence to provided recommendations, such as withholding time frames of anti-haemostatic agents before surgery.

**Figure 4. Screenshots showing the STEP protocol as part of the CLOTS app demonstrating an example patient with a high thromboembolic risk undergoing high risk surgery**

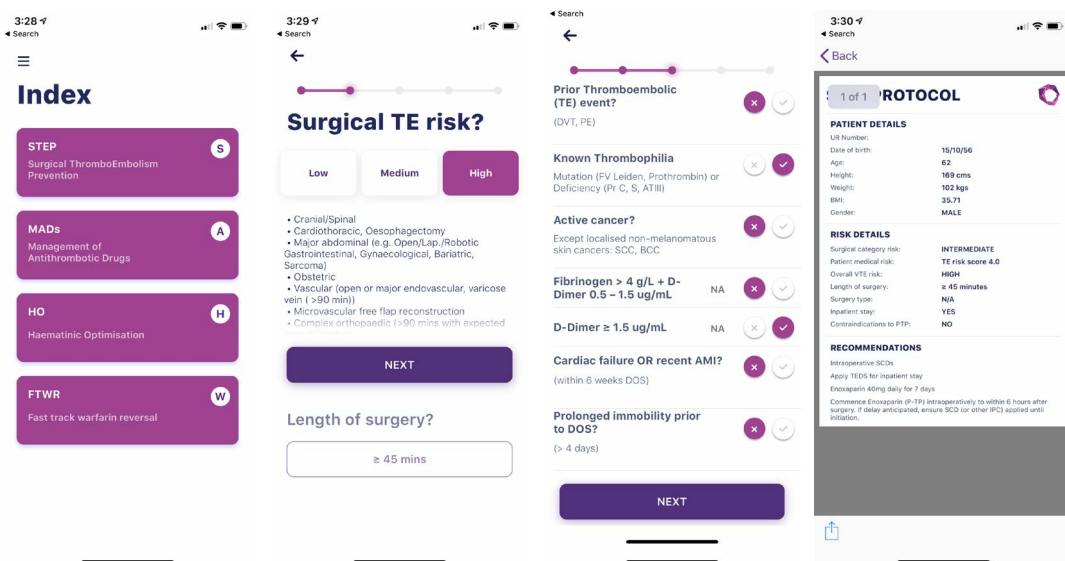

## EVALUATION, FEEDBACK AND VALIDATION

Clinician-facing decision-support apps directly influence the care that a patient receives. These apps are becoming increasingly recognised as a medical intervention and as such, should require an evaluation of their accuracy and efficacy equivalent to other therapeutic interventions that fall under medical device regulation<sup>16</sup>.

Currently there is little-to-no quality control from app stores or regulators to ensure that medical apps are evidence-based or effective. As a result of the status quo, end users cannot have confidence in the ability of most medical apps to make sound decisions. Only apps from recognised national or international providers such as Up-To-Date or apps from local health networks are trusted sources of information.

A good example of app validation was performed for the STEP module in the CLOTS app. The clinicians performed a before-and-after study<sup>14</sup> to evaluate the frequency of VTE risk assessment, the accuracy of these assessments and their impact on postoperative VTE and bleeding. After implementation, the rate of VTE risk assessment was 99%, with high concordance between baseline VTE risk and nurse-initiated risk assessment. After full implementation the rate of postoperative VTE reduced by 79% (95%CI 40 - 90%;  $P < 0.005$ ), and postoperative bleeding by 37% (95%CI 5 - 58%;  $P = 0.02$ ). It is important to note however that the app was one of many targeted interventions developed by the team to drive compliance and improve outcomes.

## LIMITATIONS AND CHALLENGES IN MOBILE APP DEVELOPMENT

The transition of decision support from primarily paper-based guidelines to a software format brings with it all of the challenges of software development. There are risks that should be planned for ahead of time to ensure that significant capital and time is not poured into a project that rapidly becomes obsolete.

Software requires frequent review to ensure it is up to date with the latest medical evidence, that users are running the latest version, that the app itself is kept up to date with updated operating systems and device interfaces. This process may take up significant resources and this should be budgeted for at the outset.

As the technological revolution continues, there are likely to be additional requirements for medical apps in addition to demonstrating sound decision support. Recording the user journey via analytics and recording the data points that led to a certain decision may become a medicolegal requirement to protect both the clinician

user and the app developer. These data points may need to be recorded in a patient's electronic medical record in the future.

Additionally, most medical apps contain a disclaimer that the information and/or recommendations that the app provides may not be accurate, up to date or complete. If medical apps are to be used to guide practice, there needs to be better legal frameworks to determine attribution of risk in case of faulty medical advice.

Formal validation of both the soundness of the backend logic, and of the positive effect the app has on clinical outcomes are likely to be important too.

## SUMMARY

Mobile apps designed for use in perioperative medicine are increasingly being developed. Like all new technologies, there is the potential for both significant benefit to clinicians, hospitals and patients, and also the potential for harm and medicolegal risk. It is important to strike a balance between encouraging innovation in this space, while maintaining standards and ensuring that mobile applications are efficacious, validated, and adhere to governance standards. Until EMR becomes more integrated, programmable and user-friendly, there is a place for standalone mobile apps, created to improve outcomes and assist clinicians to deliver world-class healthcare.

## REFERENCES

- Rogers EM. DIFFUSION OF INNOVATIONS Third Edition.; 1962. Free Press, UK.
- Sanson-Fisher RW. Diffusion of innovation theory for clinical change. *Med J Aust.* 2004;180(6):S55. doi:10.5694/j.1326-5377.2004.tb05947.x
- Myles PS, Leslie K, Chan MTV, et al. Avoidance of nitrous oxide for patients undergoing major surgery: A randomized controlled trial. *Anesthesiology.* 2007;107(2):221-231. doi:10.1097/01.anes.0000270723.30772.da
- Richards T, Baikady RR, Clevenger B, et al. Preoperative intravenous iron to treat anaemia before major abdominal surgery (PREVENTT): a randomised, double-blind, controlled trial. *Lancet.* 2020;396(10259):1353-1361. doi:10.1016/S0140-6736(20)31539-7
- Wijesundera DN, Pearse RM, Shulman MA, et al. Assessment of Functional Capacity before Major Non-Cardiac Surgery: An International, Prospective Cohort Study. *Vol 391.*; 2018. doi:10.1016/S0140-6736(18)31131-0
- Mangano DT, Layug EL, Wallace A, Tateo I. Effect of Atenolol on Mortality and Cardiovascular Morbidity after Noncardiac Surgery. *N Engl J Med.* 1996;335(23):1713-1721. doi:10.1056/NEJM199612053352301
- Devereaux PJ, Yang H, Yusuf S, et al. Effects of extended-release metoprolol succinate in patients undergoing non-cardiac surgery (POISE trial): A randomised controlled trial. *Lancet.* 2008;371(9627):1839-1847. doi:10.1016/S0140-6736(08)60601-7
- Fleisher LA, Fleischmann KE, Auerbach AD, et al. 2014 ACC/AHA guideline on perioperative cardiovascular evaluation and management of patients undergoing noncardiac surgery A report of the American College of Cardiology/American Heart Association task force on practice guidelines. *Circulation.* 2014;130(24):e278-e333. doi:10.1161/CIR.0000000000000106
- Sutton RT, Pincock D, Baumgart DC, Sadowski DC, Fedorak RN, Kroeker KI. An overview of clinical decision support systems: benefits, risks, and strategies for success. *npj Digit Med.* 2020;3(1). doi:10.1038/s41746-020-0221-y
- Chrimes N. The Vortex: A universal "high-acuity implementation tool" for emergency airway management. *Br J Anaesth.* 2016;117:i20-i27. doi:10.1093/bja/aew175
- How Much Does It Cost to Develop a Mobile App in Australia | by Appentus Technologies | Medium. [Internet] <https://medium.com/@appentustechology/how-much-does-it-cost-to-develop-a-mobile-app-in-australia-7c0afd54bc77>. Accessed April 21, 2021.
- Agarwal S, Laycock HC. The debate ROTEMs on – the utility of point-of-care testing and fibrinogen concentrate in postpartum haemorrhage. *Anaesthesia.* 2020;75(9):1247-1251. doi:10.1111/anae.15193
- ROTEM Flip cards - Test your interpretation skills! - obsgynaecritcare. <https://www.obsgynaecritcare.org/rotem-flip-cards-test-interpretation-skills/>. Accessed April 21, 2021.
- Chahal R, Alexander M, Yee K, et al. Impact of a risk-stratified thromboprophylaxis protocol on the incidence of postoperative venous thromboembolism and bleeding. *Anaesthesia.* 2020;75(8):1028-1038. doi:10.1111/anae.15077
- Byrne TJ, Riedel B, Ismail HM, et al. Fast-track rapid warfarin reversal for elective surgery: Extending the efficacy profile to high-risk patients with cancer. *Anaesth Intensive Care.* 2015;43(6):712-718. doi:10.1177/0310057x1504300608
- Watson HA, Tribe RM, Shennan AH. The role of medical smartphone apps in clinical decision-support: A literature review. *Artif Intell Med.* 2019;100. doi:10.1016/j.artmed.2019.101707

## How can anaesthetists talk to patients with obesity?

### **Natalie Smith, MBBS, BSc (Med), FRCA, FANZCA**

**Masters in Medical Education, Senior Staff Specialist, Department of Anaesthesia, Wollongong Hospital, NSW, Honorary Clinical Associate Professor, University of Wollongong, New South Wales**

Honorary Clinical Associate Professor Natalie Smith trained in anaesthesia in the UK but returned to her native Australia more than 15 years ago. Along with a diverse clinical practice, she has pursued interests in education, training, and both clinical and educational research. Improving anaesthesia for the elderly and the obese patient groups is her main ongoing clinical and academic focus.

### **Anthony Hodsdon, MBBS**

**Registrar, Department of Anaesthesia, Wollongong Hospital, New South Wales**

Dr Anthony Hodsdon is an anaesthetics registrar at Wollongong Hospital. He has broad interests in anaesthetic research including communication, airway management and obstetric anaesthesia.

### **David A Story, MBBS (Hons), MD, BMedSci(Hons), FANZCA**

**Professor and Chair of Anaesthesia, Department of Critical Care, The University of Melbourne, Victoria**

Professor David A Story's main research interest is clinically- and cost-effective approaches to reduce perioperative risk, complications, disability, and mortality. He also does translational work in acid-base disorders; and is a consumer investigator in diabetes care. He is also a staff anaesthetist at the Austin Hospital where he provides perioperative care for most procedural specialties including liver transplantation.

## INTRODUCTION

How often during pre-anaesthesia consultations do we want to discuss a patient's obesity but wonder about the most constructive approach? What is the best way to discuss unhealthy weight respectfully and effectively without offending the patient? In a survey of fellows of the Australian and New Zealand College of Anaesthetists, many specialists reported difficulty and apprehension about communicating with patients about obesity<sup>1</sup>.

The majority of respondents said that obesity was the most common clinical condition they encountered and that they had anaesthetised at least one patient with obesity on their most recent clinical day. All respondents noted that obesity increases both perioperative and lifetime risks for patients. However, anaesthetists demonstrated that they were unsure about how best to approach the problem. They were concerned about not wanting to upset or offend patients, about the current cultural situation of increasing prevalence and normalisation of obesity, and about low patient health literacy regarding obesity and its effects on anaesthesia care.

Obesity is an increasingly common problem in many countries<sup>2</sup> with many potential health implications in the perioperative period<sup>3</sup>. Rates of obesity in surgical patients have been reported to vary between 35 and 70 per cent depending on the type of surgery and can be twice the background rate of the general population<sup>4-8</sup>.

We planned a systematic literature review to assess existing guidelines and evidence of effectiveness for how anaesthetists should communicate in the preoperative period with patients who have obesity about perioperative risks and weight management. Database searches used keywords related to perioperative weight loss conversations. We found no papers that directly addressed our aim and therefore analysed the literature that we identified as most relevant in the form of a narrative review.

As anaesthetists, we face many challenges to good communication with patients<sup>9,10</sup>. Our time together is usually brief and often under time-pressure. Patients may be distracted by pain or anxiety, and may be acutely unwell or affected by medications such as strong opioids. The perioperative period is in itself a time of vulnerability for patients<sup>11</sup>. They deal with health problems of varying degrees of severity and urgency, with uncertain outcomes, admission to hospital, multiple health care providers and the loss of control that occurs with anaesthesia and surgery. The necessity for a surgical procedure may be related to lifestyle factors such as smoking and obesity. All of these factors support the need for high quality professional communication skills<sup>9,10</sup>. The multiple benefits of good communication skills in anaesthetists have long been acknowledged<sup>12</sup> but rarely studied in depth, particularly in the context of sensitive conversations<sup>13</sup>. Anaesthetists could ideally cover two related but separate issues with patients who have obesity: the risks associated with obesity in the perioperative period, and encouraging weight loss for enhanced general health.

Preoperative weight loss can be considered similar to other public health issues that anaesthetists have to address such as smoking cessation. Although most surgeons and anaesthetists agree on the benefits of perioperative smoking cessation, and think it is their responsibility to advise patients to stop smoking,

few surgeons and very few anaesthetists directly address smoking cessation with their patients<sup>14</sup>. Smoking cessation advice is more effective if delivered in the preoperative period as this results in higher longer-term quit rates compared with quitting for general health considerations<sup>15</sup>. Perioperative weight loss counselling has several parallels to smoking cessation. Guidance on how to implement perioperative weight loss counselling effectively would be helpful for our profession, our patients, and healthcare and expenditure overall.

## METHODS

We conducted a systematic literature review for the years between 2006 and 2016 asking: How can anaesthetists best conduct preoperative conversations regarding perioperative risk and weight loss with patients who have obesity? Even with assistance from professional librarians and a second attempt with expanded search terms, we were unable to find any relevant publications. There appears to be no body of anaesthesia literature on how best to approach one of the most problematic issues in our practice.

We therefore decided to explore the papers that were most closely related to this topic and that we felt could inform our study question. We identified 95 articles that were able to provide input of some value. These came from diverse healthcare backgrounds including primary care (the majority), surgery, internal medicine, paediatrics, dietetics, and psychology.

## RESULTS

We identified four final themes, with more than one present in most papers (see Table 1). The most frequent theme (63 per cent of the papers) described the barriers to conversations between patients with obesity and healthcare providers.

**Table 1. Weight loss conversation themes and sub-themes**

Barriers to conversations	Communication tools	Language and communication	Specific recommendations
<ul style="list-style-type: none"> <li>Lack of training</li> <li>Insufficient time</li> <li>Pessimism</li> <li>Poor resources</li> <li>Complex topic</li> <li>More immediate needs</li> </ul>	<ul style="list-style-type: none"> <li>Motivational interviewing</li> <li>5As (assess, advise, agree, assist, arrange)</li> <li>Written materials</li> <li>4Es (engage, empathise, educate, enlist)</li> </ul>	<ul style="list-style-type: none"> <li>Specific terminology</li> <li>Empathetic</li> <li>Patient-centred (specific)</li> </ul>	<ul style="list-style-type: none"> <li>Training for physicians</li> <li>Clear referral pathways</li> <li>Specific consultation suggestions</li> </ul>

## DISCUSSION

### Barriers to conversations

The most common perceived barriers to conducting conversations with patients about obesity were lack of skills, time, and training, and the perceived futility of such conversations. Despite time constraints, the evidence for success of brief interventions in smoking cessation is encouraging and could be extrapolated to weight loss<sup>16</sup>. Advice of any nature from a physician has been shown to be beneficial in smoking cessation<sup>17</sup>. Simply acknowledging a patient's overweight status is associated with increased desire and attempts to lose weight<sup>18</sup>. While none of the reviewed articles included preoperative anaesthesia consultations, many of the described barriers appear to be relevant to our practice.

### Communication tools

Providing relevant written materials to patients before they see the anaesthetist can help introduce the topic effectively. Once the conversation with the patient has been started, using a structured framework such as the 5As tool (ask, assess, advise, assist, arrange) can be used to continue the conversation in a non-judgemental manner. Table 2 provides an example of how this could be done in our everyday practice. Other communication strategies such as motivational interviewing can be used to further explore a patient's views on weight management<sup>19</sup>. The simplicity of the 5As approach makes it more suitable for anaesthesia consultations. The shared concept of these tools is to help patients move through the change cycle towards self-motivated behaviour change<sup>20,21</sup>.

The 5As tool was initially described for use in smoking cessation conversations<sup>22</sup>, but there is clinical evidence for its use in weight management<sup>20,23</sup>. The Australian Government Department of Health National Health and Medical Research guidelines for the management of overweight and obesity in primary care demonstrate the simplicity with which the 5As can be used<sup>24</sup>. Using a communication tool that is relatively straightforward to teach and learn will also be important for designing and implementing anaesthetist training interventions. One potential difficulty in using the 5As in the preoperative period is that "assist" and "arrange" are the most valuable aspects<sup>25</sup> but may be difficult to accomplish within the limited time frame of the preoperative consultation. Pre-arranged referral pathways to primary care, dietitians, exercise physiologists or other specialists would be particularly important for anaesthetists.

### Language and communication

Multiple papers made reference to the terminology recommended when engaging in weight loss conversations. "Weight" was the preferred term for conversations, with "fatness" the least preferred term<sup>26</sup>. Patients desired an empathetic approach from their doctor, with patient-centred communication considered of higher value than generic weight loss advice<sup>27</sup>. However, this may not provide enough motivation for some patients to promote change, specifically with regards to male patients<sup>28</sup>. Useful opening statements may be: "I am concerned that your current weight may be unhealthy – are you OK if we talk about it?", or "I would like to talk with you about your weight – is this OK?"

A good opening may lead to a "teachable moment". This is an interaction between patient and healthcare provider at a time when a patient may be particularly receptive to health information. Teachable moments are more likely when patients perceive a situation involving increased risk, potential adverse outcomes, highly emotional situations, or that challenge their personal identity<sup>29</sup>. Pending surgery, pregnancy, diagnosis of cancer, hospital admission, or major systemic illness are examples of such situations relevant to the perioperative period, which may make the preoperative consultation an ideal opportunity for stimulating behaviour change. Teachable moments have been widely used in smoking cessation, and have been reported but less widely used for managing obesity<sup>30</sup>. Patients expect to receive health information and counselling whenever they interact with healthcare professionals, and a lack of this may be perceived as an affirmation of poor health practices<sup>31</sup>. The preoperative consultation provides an ideal opportunity for anaesthetists to embrace a perioperative medicine role in promoting health behaviours that are not only beneficial in the short term for the upcoming surgery, but also for life-long health and wellbeing.

### Specific recommendations

The most common subtheme regarding specific recommendations for weight loss conversations was for physicians to be specifically trained in how to discuss weight with patients with obesity (mentioned in 19 per cent of papers). Availability of clear referral pathways to manage obesity was described in 10 per cent of papers. This ties in with the "assist" and "arrange" elements of the 5As. This is particularly relevant for anaesthetists as we do not have an ongoing relationship with patients over time.

## CONCLUSION

We found no existing literature to directly guide anaesthetists in conducting effective preoperative communications with patients who have obesity. Examining the most relevant related literature unearthed several points that are likely to be helpful. The importance of identifying and overcoming the barriers to such conversations was frequently noted, as was the value of specific communication tools and language. With predetermined referral pathways, patients can be followed through the change cycle by providers with whom they have an ongoing relationship, with the goal of long-term, sustained weight loss. Introducing such practices may help these vulnerable patients (and their providers) to achieve the best possible perioperative and longer-term outcomes, and help anaesthetists overcome their ambivalence in approaching such an important issue.

Practice points to consider:

- Train anaesthetists and other perioperative medicine practitioners in obesity-specific communication skills, including use of empathetic language.
- Patients can receive information about the effects of obesity on anaesthesia and surgery, and complete a short questionnaire about their current diet and exercise, prior to their preoperative review.
- Start the conversation by acknowledging patient obesity using an empathetic approach: "I am concerned about your unhealthy weight." or "Are you OK if we talk about your weight?"
- Use a formal communication tool such as the 5As to help structure the discussion and assess the position of the patient on the change cycle.

- Discuss the increased risks of obesity with reference to the patient and their planned surgery.
- Communication should be patient-centred and specifically tailored to the individual.
- Have pre-arranged consultation and referral pathways for ongoing care.
- Provide written materials and/or web-links for online support and reliable information for patients to take away.

**Table 2. The 5As approach to weight management\***

Ask	<ul style="list-style-type: none"> <li>▪ Permission to discuss weight.</li> <li>▪ Measure body mass index.</li> <li>▪ About comorbidities.</li> <li>▪ About other factors related to health risk, for example, smoking, alcohol, exercise.</li> </ul>
Assess	<ul style="list-style-type: none"> <li>▪ How do you feel about your weight at the moment?</li> <li>▪ Do you feel ready to think about losing some weight/improving your fitness/health?</li> </ul>
Advise	<ul style="list-style-type: none"> <li>▪ “The best thing you can do for your health is to lose weight.”</li> <li>▪ Promote the benefits of a healthy lifestyle.</li> <li>▪ Explain the benefits of weight loss for the specific surgery.</li> </ul>
Assist	<ul style="list-style-type: none"> <li>▪ The particular approach to follow will depend on results of the “assess” phase, that is, how ready the patient is to act on their obesity: patients may be ready, unsure, or not ready to change.</li> <li>▪ Help patient to identify and plan to address the barriers to weight loss that are relevant to them.</li> <li>▪ Help patient to start to develop a weight management plan.</li> </ul>
Arrange	<ul style="list-style-type: none"> <li>▪ Referral and follow-up as required (for example, to a primary care physician, dietitian, exercise physiologist or psychologist) to oversee long-term weight management.</li> </ul>

\*Modified from Australian government clinical practice guidelines for managing obesity<sup>32</sup> and Royal Australian College of General Practitioners smoking cessation guidelines<sup>33</sup>.

This article is based on our publication on this topic in *Perioperative Medicine*<sup>34</sup>.

## REFERENCES

- Hincks C. Fellows call for action on obesity. *Australia and New Zealand College of Anaesthetists Bulletin*, Dec 2015:32-3.
- Twells LK, Gregory DM, Reddigan J, Midodzi WK. Current and predicted prevalence of obesity in Canada: a trend analysis. *CMAJ Open*. 2014;2(1):E18-26.
- Nightingale CE, Margaron MP, Shearer E, et al. Peri-operative management of the obese surgical patient 2015. *Anaesthesia*. 2015;70(7):859-76.
- Freckelton L, Lambert K, Smith NA, et al. Impact of body mass index on utilization of selected hospital resources for four common surgical procedures. *ANZ Journal of Surgery*. 2019;89(7-8):842-7.
- Hamlin RJ, Sprung J, Hofer RE, Schroeder DR, Weingarten TN. Obesity trends in the surgical population at a large academic center : a comparison between 1989-1991 to 2006-2008 epochs. *Acta Chir Belg*. 2013;113(6):397-400.
- Harms S, Larson R, Sahnoun AE, Beal JR. Obesity increases the likelihood of total joint replacement surgery among younger adults. *Int Orthop*. 2007;31(1):23-6.
- Mullen JT, Moorman DW, Davenport DL. The obesity paradox: body mass index and outcomes in patients undergoing nonbariatric general surgery. *Ann Surg*. 2009;250(1):166-72.
- STARSurG-Collaborative. Multicentre prospective cohort study of body mass index and postoperative complications following gastrointestinal surgery. *Br J Surg*. 2016;103(9):1157-72.
- Hool A, Smith AF. Communication between anaesthesiologists and patients: how are we doing it now and how can we improve? *Curr Opin Anaesthesiol*. 2009;22(3):431-5.
- Kopp VJ, Shafer A. Anesthesiologists and perioperative communication. *Anesthesiology*. 2000;93(2):548-55.
- Cousley A. Vulnerability in perioperative patients: a qualitative study. *J Perioper Pract*. 2015;25(12):246-56.
- Cyna AM, Andrew MI, Tan SG. Communication skills for the anaesthetist. *Anaesthesia*. 2009;64(6):658-65.
- Kindler CH, Szirt L, Sommer D, Hausler R, Langewitz W. A quantitative analysis of anaesthetist-patient communication during the pre-operative visit. *Anaesthesia*. 2005;60(1):53-9.
- Warner DO, Sarr MG, Offord KP, Dale LC. Anesthesiologists, general surgeons, and tobacco interventions in the perioperative period. *Anesth Analg*. 2004;99(6):1766-73.
- de Hoyos A, Southard C, DeCamp MM. Perioperative smoking cessation. *Thoracic surgery clinics*. 2012;22(1):1-12, v.
- Lee SM, Landry J, Jones PM, Buhrmann O, Morley-Forster P. Long-term quit rates after a perioperative smoking cessation randomized controlled trial. *Anesth Analg*. 2015;120(3):582-7.
- Stead LF, Bergson G, Lancaster T. Physician advice for smoking cessation. *Cochrane Database Syst Rev*. 2008(2):CD000165.
- Gordon A, Black K. Doctors need to be taught how to discuss their patients' excess weight. *The Conversation*. 2016.
- Stead LF, Buitrago D, Preciado N, et al. Physician advice for smoking cessation. *Cochrane Database of Systematic Reviews* 2013, Issue 5. Chichester, UK: John Wiley & Sons, Ltd.
- Jay M, Gillespie C, Schlar S, Sherman S, Kalet A. Physicians' use of the 5As in counseling obese patients: is the quality of counseling associated with patients' motivation and intention to lose weight? *BMC Health Serv Res*. 2010;10(1):159.
- Schwartz RP. Motivational Interviewing (Patient-Centered Counseling) to Address Childhood Obesity. *Pediatr Ann*. 2010;39(3):154-8.
- Manley MW, Epps RP, Glynn TJ. The clinician's role in promoting smoking cessation among clinic patients. *Med Clin North Am*. 1992;76(2):477-94.
- Alexander SC, Cox ME, Turer CLB, et al. Do the five A's work when physicians counsel about weight loss? *Fam Med*. 2011;43(3):179.
- Fiore MC, Jaén CR, Baker TB, et al. Treating tobacco use and dependence: 2008 update. *Clinical Practice Guideline. Executive Summary. Respir Care*. 2008;53(9):1217-22.
- Pollak KI, Alexander SC, Coffman CJ, et al. Physician communication techniques and weight loss in adults: Project CHAT. *Am J Prev Med*. 2010;39(4):321-8.
- Dutton GR, Tan F, Perri MG, et al. What words should we use when discussing excess weight? *J Am Board Fam Med*. 2010;23(5):606-13.
- Huang J, Yu H, Marin E, et al. Physicians' weight loss counseling in two public hospital primary care clinics. *Acad Med*. 2004;79(2):156-61.
- Gray CM, Hunt K, Lorimer K, et al. Words matter: a qualitative investigation of which weight status terms are acceptable and motivate weight loss when used by health professionals. *BMC Public Health*. 2011;11(1):513.
- McBride CM, Puleo E, Pollak KI, et al. Understanding the role of cancer worry in creating a “teachable moment” for multiple risk factor reduction. *Soc Sci Med*. 2008;66(3):790-800.
- Phelan S. Pregnancy: A “teachable moment” for weight control and obesity prevention. *Am J Obstet Gynecol*. 2010;202(2):135.e1.
- Pool AC, Kraschnewski JL, Cover LA, et al. The impact of physician weight discussion on weight loss in US adults. *Obesity Research & Clinical Practice*. 2014;8(2):e131-e9.
- NHMRC. Clinical practice guidelines for the management of overweight and obesity in adults, adolescents and children in Australia. Melbourne: National Health and Medical Research Council. 2013.
- RACGP. Supporting smoking cessation: A guide for health professionals. 2nd edn. East Melbourne, Vic: RACGP; 2019.
- Hodsdon A, Smith NA, Story DA. Preoperative communication between anaesthetists and patients with obesity regarding perioperative risks and weight management: a structured narrative review. *Perioper Med* 9, 24 (2020).

## Preparing the elderly patient for elective non-cardiac surgery

### Naomi Osborne, MD BBSc

Resident Medical Officer, Fiona Stanley Fremantle Hospitals Service, Western Australia

Dr Naomi Osborne is a Resident Medical Officer at Fiona Stanley Hospital. She has a keen interest in perioperative medicine, and, drawing on her background in behavioural science, a passion for understanding the role of human factors in medicine.

### Leena Nagappan, MBBS FANZCA MMed

Consultant Anaesthetist, Fiona Stanley Fremantle Hospitals Service, Western Australia

Dr Leena Nagappan is the chairperson for the Western Australian Perioperative Medicine Network (WAPOM) and Anaesthesia Clinical Lead for the Perioperative Medicine services at Fiona Stanley Hospital. She plays an active role in promoting the POM subspecialty in WA and has a keen interest in preoperative risk stratification and risk modification, especially in the elderly patient.

### Kevin Kwan, MBBS MMed FRACP

Specialist Physician and Geriatrician, Joondalup Health Campus, Western Australia

Dr Kevin Kwan is a senior clinical lecturer with the University of Western Australia and Director of Clinical Training at Joondalup Health Campus. He has a keen interest in all aspects of aged care with a subspecialty passion for cognitive frailty and perioperative medicine. To further his expertise, he completed the Master of Medicine (Monash) specialising in perioperative medicine.

## INTRODUCTION

In Australia, in line with the rest of the developed world, the elderly population is increasing at a faster rate than any other age cohort<sup>1</sup>. As a result of this growth, the proportion of people aged 65 and older is expected to increase from 17 per cent of the Australian population in 2017 to 22 per cent by 2050<sup>1</sup>. The impact of these changing demographics on the healthcare sector in general is considerable, and the health system will need to adapt to these challenges. Older people are undergoing surgery at double the rate of the younger population<sup>2</sup> and face an increased risk of adverse perioperative outcomes, including specific organ dysfunction, delirium and new dependence in activities of daily living<sup>3,4</sup>. Therefore, there is increasing awareness regarding the importance of accurate preoperative assessment and optimisation in this patient group.

## RISK STRATIFICATION

Risk assessment in the geriatric patient provides answers to questions arising throughout their perioperative journey as follows:

- Is the patient compatible with the planned surgery?
- Is the planned surgery suitable for the patient?
- Do the benefits of the selected intervention outweigh non-intervention?

Robust practices in risk assessment of the geriatric patient pave the way for correct identification and optimisation of patients before surgery. There seems to be heterogeneity in available guidelines on perioperative management of geriatric patients, regarding both assessment domains and tools<sup>5</sup>. Correspondingly, there is less emphasis on the geriatric syndromes and geriatric-related outcomes in most of the perioperative assessment tools that are currently being used.

Appropriately designed tools are available for this purpose. However, some are better suited for the ageing population, whereas others must be considered carefully when used to guide perioperative decision-making. As an example, the American College of Surgeons-National Surgical Quality Improvement Program (ACS-NSQIP) Surgical Risk Calculator (SRC) is a popular prediction tool for undesirable outcomes that facilitates preoperative discussion of risks and may be used as a visual aid to assess outcomes<sup>6</sup>. Derived from a large perioperative database and encompassing a vast variety of surgical procedures, it was developed in 2013 and continues to be a widely adapted tool in preoperative evaluation, decision-making and informed-consent processes<sup>7</sup>. However, it was not designed specifically for the geriatric population, leading to variable performance in the predictive capabilities of the outcomes when utilised in elderly patients. The predictive utility of the ACS-NSQIP surgical risk calculator in elderly patients undergoing lumbar surgery proved to be useful for outcomes such as death, renal failure and readmission rates but failed to accurately predict other

serious complications<sup>9</sup>. Similarly, when applied to elderly patients undergoing hepatectomy for hepatocellular carcinoma, the tool underestimated the risk of some complications (such as renal failure), and was no better than chance at predicting the risk of readmission and 30-day mortality<sup>9</sup>. Specifically for cardiovascular outcomes, the predictions of ACS-NSQIP calculator were shown to be improved in elderly patients when combined with biomarkers, such as high-sensitivity C-reactive protein<sup>10</sup>.

An upgrade of the ACS-NSQIP calculator for geriatric patients is the addition of geriatric-specific outcomes i.e. pressure ulcer, delirium, new mobility aid and functional decline which helps prediction capabilities<sup>11</sup>. It is done by incorporating six domains of preoperative information; current living situation, fall history, use of mobility aids, cognitive impairment, surrogate-signed consent, and palliative care on admission. This information is usually readily available during preoperative evaluation. This latest enhancement is likely to see the ACS-NSQIP SRC gain further traction in systems focusing on geriatric preoperative assessment<sup>11</sup>. It is especially important as geriatric-specific variables have been shown to be related to readmission rates when looked at in the surgical setting<sup>12</sup>.

## THE RECOGNITION OF FRAILITY IN THE PERIOPERATIVE ASSESSMENT

In recent times, it has been recognised that because of the heterogenous nature of the ageing process, chronological age has limited predictive value in assessing how an individual will cope with the stress of surgery<sup>13</sup>. In particular, the concept of frailty has come into focus, both as an independent predictor of perioperative outcomes and as a target for interventions that modify risks to improve long term outcomes.

## WHAT IS FRAILITY, AND WHY SHOULD WE MEASURE IT?

Frailty has been described as a multi-dimensional state of decreased reserve and decreased resistance to stressors that often increases with age<sup>14</sup>. It is characterised by an accelerated decline across multiple physiological systems<sup>15</sup>. Others have used the term “reduced functional homeostasis”, to illustrate that the frail individual has a greater proportion of their physiological reserves engaged in maintaining homeostasis, and therefore decreased ability to do so in the face of stressors<sup>16</sup>. As a result of this reduced reserve, the frail patient is more likely to decompensate in the perioperative period, a time of increased inflammation and stress<sup>17</sup>. This is reflected in an increased risk of poor outcomes, such as deconditioning, loss of functional independence, need for residential aged care and mortality<sup>14</sup>. Hence, frailty rather than age alone may identify those with greatest clinical need<sup>18</sup>. Indeed, two individuals of a similar age and with the same list of medical comorbidities may in fact have very different levels of frailty. It is important to note that frailty is not synonymous with medical comorbidities or disability, although they can co-exist<sup>14</sup>.

Frailty is of increasing relevance to the perioperative physician, being increasingly seen in the population presenting to the pre-admission clinic. It is estimated to affect approximately 10 per cent of people aged 65 years and older, rising to 25-50 per cent in those aged over 85 years<sup>19</sup>. Given that elderly surgical patients have a higher prevalence of frailty compared to their community dwelling peers<sup>20</sup>, these numbers are likely to be an underestimate when considering elderly surgical patients. A systematic review of the prevalence of frailty in the general surgical population estimated frailty was present in 10.4-37.0 per cent of patients with a mean age of 61-77 years<sup>21</sup>. Thirty-day mortality rate was 8 per cent (95% CI 4-12), with significantly increased complication rates of 24 per cent in the frail compared to 5 per cent in the non-frail population<sup>21</sup>. Mean length of stay in the frail cohort was also increased from 9.6 days versus 6.4 days compared to the non-frail<sup>21</sup>. Furthermore, frailty has been found to be independently associated with adverse outcomes in the perioperative period<sup>22</sup>, and is better able to predict these adverse events compared with traditional scoring systems such as the American Society of Anaesthesiologists (ASA) and Physical Status System and Physiological and Operative Severity Score for the Enumeration of Mortality and Morbidity (POSSUM)<sup>23,24</sup>.

In a recent systematic review of 56 studies which included more than one million patients, frailty was a strong predictor of poor outcomes<sup>25</sup>, including mortality at 30 days and one year, delirium and institutionalisation. Studies were of fair to good quality and included oncological, elective general surgery, orthopaedic surgery, emergency and vascular surgery<sup>25</sup>. The presence of frailty was associated with increased 30-day mortality (RR 3.71, 95% CI 2.89-4.77), one-year mortality (RR 2.39, 95% CI 2.02-2.83), postoperative delirium (RR 2.13, 95% CI 1.23-3.67) and discharge to residential aged care (RR 2.30, 95% CI 1.81-2.92).

Importantly, there is growing attention regarding the potential for preoperative interventions aimed at modifying the risks associated with frailty. Indeed, Hall et al<sup>26</sup> found that preoperative screening for frailty using the Risk Analysis Index (RAI) was associated with improved survival at 30, 180 and 365 days postoperatively. A joint statement from the American College of Surgeons and the American Geriatrics Society (with representatives from multiple specialties including anaesthesia) recommends that all geriatric patients planned for surgery should be evaluated for frailty and have this documented in their record<sup>27</sup>. This was reiterated by the Society

of Perioperative Assessment and Quality Improvement (SPAQI)<sup>28</sup>. The presence of frailty may also inform shared decision making perioperatively, by more accurately predicting expected outcomes and assisting the perioperative physician and patient to ensure decisions are congruent with their values<sup>28</sup>. The predictive accuracy of frailty tools in relation to patient-centred outcomes, quality of life and disability are an area of ongoing research.

## HOW TO MEASURE AND SCREEN FOR FRAILITY

Despite the increasing awareness of the importance of frailty in the perioperative period, there is currently no single standardised method for its measurement, with much heterogeneity of frailty tool selection and implementation described in the literature<sup>5,29</sup>. The choice of frailty screening tool in clinical practice for any perioperative service needs to take into account accuracy and feasibility of implementation<sup>29</sup>. However, there is limited evidence comparing outcomes from different frailty instruments in the perioperative setting. The most commonly cited frailty screening tools in the literature are the Rockwood Clinical Frailty Scale (CFS), the Edmonton Frailty Score, Modified Frailty Index and The Fried Frailty Phenotype<sup>5,14,30,31</sup>.









## CLINICAL FRAILITY SCORE (CFS)

The CFS<sup>30</sup> is a seven-point frailty screening tool based upon a person's functional phenotype, derived from the Canadian Study of Health and Aging data as depicted in Figure 1. Its performance in identifying frailty has been found to correlate well with other frailty tools, with each increased increment in the scale being associated with a significant increase in medium term mortality and entry into institutional care<sup>30</sup>. Advantages are its ease of use by non-geriatricians without additional adjunct tools or training, and increasing adoption within Australia in the perioperative setting. In a recent, single centre Western Australian cohort study of hip fracture patients, the CFS demonstrated greater discriminative ability than the ASA in predicting mortality<sup>32</sup>. Each increment in CFS was significantly associated with increasing age, admission from residential care, one-year mortality and inversely related to discharge to private residence (see Table 1). Indeed, the CFS has been included in the dataset for the Australian and New Zealand Hip Fracture Registry for 2021<sup>33</sup>.

The CFS alone does not directly assess comorbidity burden nor cognition, and additional testing is required to assess for cognitive frailty. Despite this, a systematic review of available frailty tools in the perioperative setting reported the CFS was most strongly associated with mortality and non-favourable discharge (OR 4.89, 95% CI 1.83-13.05 and OR 6.31; 95% CI 4.00-9.94)<sup>29</sup>.

Figure 1. Rockwood Clinical Frailty Scale<sup>34</sup>

Reproduced with permission.

CLINICAL FRAILITY SCALE	
	<b>1</b> <b>VERY FIT</b> People who are robust, active, energetic and motivated. They tend to exercise regularly and are among the fittest for their age.
	<b>2</b> <b>FIT</b> People who have no active disease symptoms but are less fit than category 1. Often, they exercise or are very active occasionally, e.g., seasonally.
	<b>3</b> <b>MANAGING WELL</b> People whose medical problems are well controlled, even if occasionally symptomatic, but often are not regularly active beyond routine walking.
	<b>4</b> <b>LIVING WITH VERY MILD FRAILITY</b> Previously “vulnerable,” this category marks early transition from complete independence. While not dependent on others for daily help, often symptoms limit activities. A common complaint is being “slowed up” and/or being tired during the day.
	<b>5</b> <b>LIVING WITH MILD FRAILITY</b> People who often have more evident slowing, and need help with high order instrumental activities of daily living (finances, transportation, heavy housework). Typically, mild frailty progressively impairs shopping and walking outside alone, meal preparation, medications and begins to restrict light housework.
	<b>6</b> <b>LIVING WITH MODERATE FRAILITY</b> People who need help with all outside activities and with keeping house. Inside, they often have problems with stairs and need help with bathing and might need minimal assistance (cuing, standby) with dressing.
	<b>7</b> <b>LIVING WITH SEVERE FRAILITY</b> Completely dependent for personal care, from whatever cause (physical or cognitive). Even so, they seem stable and not at high risk of dying (within ~6 months).
	<b>8</b> <b>LIVING WITH VERY SEVERE FRAILITY</b> Completely dependent for personal care and approaching end of life. Typically, they could not recover even from a minor illness.
	<b>9</b> <b>TERMINALLY ILL</b> Approaching the end of life. This category applies to people with a life expectancy <6 months, who are not otherwise living with severe frailty. (Many terminally ill people can still exercise until very close to death.)

SCORING FRAILITY IN PEOPLE WITH DEMENTIA	
The degree of frailty generally corresponds to the degree of dementia. Common symptoms in mild dementia include forgetting the details of a recent event, though still remembering the event itself, repeating the same question/story and social withdrawal.	In moderate dementia, recent memory is very impaired, even though they seemingly can remember their past life events well. They can do personal care with prompting.
	In severe dementia, they cannot do personal care without help.
	In very severe dementia they are often bedfast. Many are virtually mute.

 Clinical Frailty Scale ©2005-2020 Rockwood, Version 2.0 (EN). All rights reserved. For permission: www.geriatricmedicine.ca  
Rockwood K et al. A global clinical measure of fitness and frailty in elderly people. CMAJ 2005;173:489-495.



**Table 1. Clinical Frailty Scale and patient characteristics and outcomes after proximal femur fracture<sup>33</sup>**

Variable	CFS 1-3 (n=30)	CFS 4 (n=91)	CFS 5 (n=117)	CFS6 (n=70)	CFS 7-9 (n=151)	p-value
Mean ASA, grade (SD)	2.6 (0.8)	2.8 (0.6)	3.0 (0.6)	3.2 (0.5)	3.0 (0.5)	<0.001*
Mean age, years (SD)	73.8 (8.8)	80.3 (9.0)	84.3 (8.3)	84.7 (6.9)	86.6 (7.3)	<0.001*
Admitted from residential care, n (%)	6 (7.5)	10 (11)	11 (9.4)	16 (22.9)	115 (76.2)	<0.001†
Mean acute LOS, days (SD)	3.6 (1.5)	3.7 (2.5)	4.4 (3.7)	4.8 (3.0)	4.3 (2.0)	0.027*
Discharged to private residence, n (%)	27 (33.8)	13 (14.3)	8 (6.8)	3 (4.3)	3 (2.0)	<0.001†
Discharged to rehabilitation, n (%)	47 (58.8)	68 (74.7)	97 (82.9)	55 (78.6)	50 (33.1)	<0.001†
Inpatient death, n (%)	0 (0)	0 (0)	3 (2.6)	1 (1.4)	7 (4.6)	0.077†
30-day mortality, n (%)	1 (1.3)	4 (4.4)	6 (5.1)	5 (7.1)	22 (14.6)	0.004†
One-year mortality, n (%)	3 (3.8)	13 (14.3)	28 (23.9)	28 (40)	63 (41.7)	<0.001†

ASA, American Society of Anaesthesiologists; LOS, length of stay

\*Analysis of variance

†Chi-squared test

## EDMONTON FRAILTY SCALE

Another commonly cited tool in the frailty perioperative literature is the Edmonton Frailty Scale<sup>31</sup>, which is outlined in Table 2. The advantage of the Edmonton Scale is that it assesses domains including cognition, polypharmacy, functional status and social support that are important to multidisciplinary perioperative planning, and which are not necessarily included in other frailty screening tools. The Edmonton Scale has been described as an abbreviated comprehensive geriatric assessment and is predictive of perioperative mortality<sup>29,31,35</sup>.

**Table 2. Edmonton Frailty Scale<sup>31</sup>**

Frailty domain	Item	0 point	1 point	2 points
Cognition	Please imagine that this pre-drawn circle is a clock. I would like you to place the numbers in the correct positions then place the hands to indicate a time of “ten after eleven”	No errors	Minor spacing errors	Other errors
General health status	In the past year, how many times have you been admitted to a hospital?	0	1-2	>2
	In general, how would you describe your health?	“Excellent”, “Very good”, “Good”	“Fair”	“Poor”
Functional independence	With how many of the following activities do you require help? (meal preparation, shopping, transportation, telephone, housekeeping, laundry, managing money, taking medications)	0-1	2-4	5-8
Social support	When you need help, can you count on someone who is willing and able to meet your needs?	Always	Sometimes	Never

Medication use	Do you use five or more different prescription medications on a regular basis?	No	Yes	
	At times, do you forget to take your prescription medications?	No	Yes	
Nutrition	Have you recently lost weight such that your clothing has become looser?	No	Yes	
Mood	Do you often feel sad or depressed?	No	Yes	
Continence	Do you have a problem with losing control of urine when you don't want to?	No	Yes	
Functional performance	I would like you to sit in this chair with your back and arms resting. Then, when I say “go” please stand up and walk at a safe and comfortable pace to the mark on the flow (approximately 3 metres away), return to the chair and sit down	0-10s	11-20s	One of: >20s, or patient unwilling or requires assistance
Total	Final score is the sum of column totals			

Total: /17

Scoring:

0-5= Not frail

6-7= Vulnerable

8-9= Mild frailty

10-11= Moderate frailty

12-17= Severe frailty

## ALTERNATIVE FRAILTY SCREENING TOOLS

Other commonly cited tools in use for describing frailty perioperatively are the Frailty Index<sup>36</sup> and the Fried Frailty Phenotype<sup>14</sup>. The Frailty Index assesses multiple domains, which then helps to identify the areas which would most benefit from preoperative intervention. It is however relatively time consuming and is best performed by staff with geriatric expertise<sup>28</sup>. The Frailty Index has since been simplified into an eleven factor and subsequently a five-factor modified frailty index (mFI-5)<sup>37</sup>. The mFI-5 scores for co-existent diabetes, hypertension, congestive heart failure, chronic obstructive pulmonary disease and functional status limiting independence. An increasing score (>2) is a strong predictor of mortality and postoperative complication.

The Fried Frailty Phenotype (see Table 3) assesses five domains: unintentional weight loss, self-reported exhaustion, hand-grip weakness, slow walking speed (a timed-up-and-go) and low physical activity. A score of one to two is considered pre-frail and greater than two identifies for frailty. While simple to use, disadvantages of the Fried Frailty scoring are that it requires special equipment (a hand-grip dynamometer) and does not as clearly identify areas which would benefit from intervention<sup>14,28,37</sup>.

**Table 3. Fried Frailty Phenotype Index<sup>14</sup>**

Criteria	Measurement
1. Weight loss	>4.5kg (10lb) in previous year or 5% body weight OR BMI < 18.5
2. Fatigue	Not full of energy; Resting in bed during the day
3. Low physical activity	Sedentary
4. Hand grip strength	Lowest 20% by gender/BMI
5. Slow walking speed	Slowest 20% or timed up and go (TUG) < 19s

Scoring:

Fit: no criteria met

Pre-frail: 1-2 criteria met

Frail: >2 criteria met

With more than 50 frailty tools cited in the literature, other measures, such as the FRAIL scale and Risk Analysis Index (RAI) have been identified for use in different settings and by different specialties, with none yet shown to be superior to the others<sup>28,38,39</sup>. Indeed, Alvarez-Nebreda and colleagues<sup>28</sup> note that given the current lack of definitive evidence, the choice of how to best screen for frailty is institution specific, depending on the particular resources and limitations of the setting, such as the availability of inter-disciplinary staff and the characteristics of the patient population.

Although outside of the scope of the current review, it is of interest to note briefly the efforts by Bentov and colleagues<sup>40</sup> to identify radiological markers of frailty. Not dissimilarly, others have looked at potential biochemical markers of frailty such as IL6, CRP and TNF- $\beta$  with unconvincing results to date<sup>41</sup>. Given that other tools to assess frailty require active patient participation, these methods may have a future place in the preoperative assessment of the acutely unwell patient undergoing emergency surgery.

## IDENTIFICATION AND RELEVANCE OF COGNITIVE FRAILTY

An estimated one in six elective surgical patients have pre-existing cognitive impairment<sup>42,43</sup>. One randomised trial of vascular surgical patients undergoing preoperative comprehensive geriatric assessment (CGA) identified that 46.5 per cent of patients had undiagnosed cognitive impairment, while the Australian and New Zealand Hip Fracture Registry reported a cognitive impairment in 37 per cent of patients presenting with a neck of femur fracture<sup>39</sup>. Cognitive frailty is the most significant risk factor for postoperative cognitive dysfunction, delirium and consequent functional decline, increased length of stay and mortality risk<sup>42-44</sup>. Importantly, acute cognitive decline following surgery can take days to weeks to improve and may not be fully reversible.

Specific interventions regarding cognitive frailty are mostly based upon best practice guidelines<sup>45</sup>. Co-management with a geriatrician led multidisciplinary team as well as nursing staff skilled in recognition and management of the cognitively frail may be beneficial<sup>28,40</sup>. Some hospitals will have a dementia or cognitive nurse specialist who can be asked to review, educate and champion the implementation of best practice strategies for patients at risk. It is preferable to implement strategies proactively to prevent delirium as it is often more difficult to manage once onset has occurred. The preferred treatment is to avoid or identify and remove potential underlying causes while providing supportive care. However, pragmatically, the onset can be multifactorial in aetiology.

## STRATEGIES FOR REDUCING THE RISK OF DELIRIUM IN THE PERIOPERATIVE PERIOD

Strategies for managing cognitive frailty are multi-dimensional. The early identification of cognitive frailty allows for implementation of strategies, including avoidance of potential neurological insults, including polypharmacy with high dose opioid analgesia, gabapentanoids and anticholinergics in these patients<sup>44-46</sup>. Routine young adult opioid dosing may not be appropriate for those who are cognitively frail, where instead an individualised opioid sparing approach, balancing analgesia efficacy, past response and cognitive side effects is necessary. This may include regular paracetamol and short term NSAIDs in the absence of contraindications. Consensus among geriatricians is that tramadol, with its multi-receptor affinity, should be avoided in the cognitively frail and used with caution in frail patients who have tolerated it previously.

Anti-psychotic medication used in the management of behavioural and psychological symptoms of dementia (BPSD) (for example, olanzapine) may have a high anti-cholinergic affinity and while effective at sedation, may prolong delirium and post-operative cognitive dysfunction. These are best avoided and replaced with non-pharmacological strategies. If necessary, age-appropriate doses of haloperidol or risperidone can be prescribed, as outlined in the Therapeutic Guidelines and shown in Table 4<sup>47</sup>. The cost of additional carer non-pharmacological support is far less than the prolonged length of stay and complications from delirium.

**Table 4. Suggested dosing of antipsychotic medications in elderly patients<sup>46</sup>**

Antipsychotic medication	Suggested dosing
Haloperidol	0.5mg orally as single dose
Olanzapine	1.25 to 2.5mg orally as single dose
Risperidone	0.5mg orally as single dose
Quetiapine*	25mg orally as single dose

\*Quetiapine is the preferred choice for patients with Parkinson disease or dementia with Lewy bodies, as the typical antipsychotics can worsen motor symptoms in these patients.

Where practical, a support person such as a family member may be advised to stay and assist in orientating a cognitively frail person in the immediate postoperative phase. The time it takes for a patient with dementia to orientate themselves to their new environment can be variable. At the time of writing, COVID-19 visitor restrictions may be a barrier to this implementation and advocating for an exception to visitor restrictions should be made on a case-by-case basis. Other non-pharmacological interventions include early mobilisation, avoiding unnecessary delays for surgery, prolonged bed rest, fasting or inadequate nutrition.

Once delirium occurs this is best co-managed with a geriatrician, in an environment conducive to cognitive recovery (often not the HDU/ICU or acute surgical ward) with nursing staff skilled in non-pharmacological behavioural management. The Australian Clinical Care Standard for delirium outlines the best evidence based practice regarding screening for, assessing, preventing and managing delirium<sup>45</sup>. A chapter on postoperative delirium was recently published in *Australasian Anaesthesia 2019*, and provides an overview on the management of patients at risk of delirium in the perioperative period<sup>48</sup>.

## THE ROLE OF COMPREHENSIVE GERIATRIC ASSESSMENT

Comprehensive geriatric assessment, which has its roots in the origins of geriatric medicine<sup>49</sup>, is “a multidimensional interdisciplinary diagnostic process focused on determining a frail elderly person’s medical, psychological and functional capability in order to develop a coordinated and integrated plan for treatment and long-term follow up”<sup>50</sup>. It is important to note that comprehensive geriatric assessment is a bespoke assessment tailored specifically for an individual and their goals of care. Many geriatricians will allow for a 60-minute attendance for a complex comprehensive geriatric assessment, although a targeted one can be performed in less time.

While not limited to the preoperative setting, ideally, the timing of a preoperative comprehensive geriatric assessment should allow for expedited investigation and/or intervention without delaying surgery, if possible. The mandate of a perioperative physician should be to proactively identify and anticipate perioperative issues, aid in shared decision making and champion best evidence-based practice to facilitate a smooth perioperative journey. The authors believe that determining whether a patient is “fit for surgery” is not the purpose of a comprehensive geriatric assessment.

### Components of a comprehensive geriatric assessment as adapted from the Medicare Benefits Schedule<sup>51</sup>:

1. Evaluation of the medical, physical, psychological, social and functional aspects of a patient’s health, including the use of standardised assessment tools if indicated.
2. Identification and prioritisation of a patient’s problems and care needs.
3. Formulation of a detailed care plan with short- and long-term goals along with recommended intervention strategies likely to improve or maintain health status.
4. Discussion with the patient to educate them on identified issues, anticipated outcomes and interventions.
5. Engagement with involved care providers (GP, perioperative team) and the patient.

## OUTLINE OF A COMPREHENSIVE GERIATRIC ASSESSMENT FROM A GERIATRICIAN PERSPECTIVE

The structure of the comprehensive geriatric assessment varies with the setting, context, and individual clinician. However, a suggested template of a preoperative comprehensive geriatric assessment is outlined below:

### Introduction: Anticipated surgery; date for surgery and patient expectations

A common introduction to build rapport is to discuss a patient’s intended surgery, reason for surgery and their expectations. The timeline should be established as this may inform choice and urgency of any intervention.

Where a perioperative physician is familiar with the procedure, the comprehensive geriatric assessment should include education and alignment of patient expectations with the anticipated perioperative course. This includes goals in the preoperative and immediate perioperative period, pain management, length of stay, delirium risk, early mobilisation, and anticipated need (if any) for rehabilitation or additional multidisciplinary support. These principles are aligned with those in the enhanced recovery after surgery (ERAS) literature<sup>52,53</sup>.

### Identification and prioritisation of relevant medical issues

This is a targeted systems enquiry to identify issues that may require proactive perioperative involvement or intervention. This list is not all-inclusive and should be tailored to the individual.

Cardiovascular:	Screen for presence or stability of coronary artery disease, heart failure symptoms, arrhythmia, postural hypotension and recent decompensation.
Respiratory:	Screen for shortness of breath, asthma, pulmonary comorbidity. If chronic airways disease is in the history, further questioning on exacerbation history, prior need for non-invasive ventilation or a history of Type I or II respiratory failure should be elicited. Ask about a history of obstructive sleep apnoea (especially in the obese patient) and compliance with CPAP if applicable.
Smoking:	All patients should have a smoking history elicited and intervention to stop smoking considered as part of the assessment for current smokers.
Haematological:	History of previous thrombosis, thrombophilia or previous post-operative bleeding. The topic of preoperative iron testing and patient blood management is beyond the scope of this chapter.
Endocrine:	Diabetes (including HbA1c), presence of macro/microvascular complications and adequacy of glucose control. Patients on insulin will require clear instruction perioperatively and ideally should be first on an operative list to minimise prolonged fasting. Cushingoid patients may be at risk of adrenal insufficiency. A history of weight loss and nutrition may be applicable.
Neurological:	Identification of any neurological comorbidity, including recent cerebrovascular events or systemic neurodegenerative diseases (for example, Parkinson's disease) which may impact the perioperative period.
Renal:	Identification of significant renal disease by history and review of prior UEC may inform prescribing practice. Most frail patients would have had biochemistry results within the last six months arranged by their primary care provider.
Other:	Other comorbidities such as autoimmune disease, cancer, gastrointestinal, musculoskeletal or rheumatological complaints usually become evident during history, examination and review of the medication list.

### Previous surgical history

Brief outline of past surgery, whether length of stay was within expected norms or rehabilitation required.

Specifically enquire about past reactions to anaesthesia, opioid analgesia and common complications including prior delirium or nausea and if a causative agent was identified. Previous perioperative nausea and delirium is a risk factor for recurrence.

### Cognitive screening and frailty

A brief cognitive screening tool should be utilised together with collateral history, such as informant concerns regarding cognitive decline.

The role of a cognitive screening tool is to screen for presence of cognitive impairment, and the choice of which tool to use will depend on the clinician's personal preference and experience. Commonly used examples include the Mini-COG, Abbreviated Mental Test Score (AMTS), Mini-Mental State Examination and Montreal Cognitive Assessment. The Mini-COG and AMTS are the most time efficient and require minimal training whereas geriatricians may choose a more comprehensive screening tool.

An assessment of patient frailty described earlier should be part of the CGA.

### Overview of patient's home situation, social support on discharge and functional state

Current independence (or dependence) with activities of daily living and identification of potential functional impact as a result of the surgery should be identified. This may include an overview of mobility, the use of walking aids, bed transfers, toileting, showering and anticipated assistance from family, carers or formal services. A patient who lives alone requires independence with transfers, mobility and toileting at the bare minimum to return home.

The Duke Activity Status Index provides a simple template of estimated functional reserve, whilst tools such as the Risk Assessment and Prediction Tool (RAPT) developed by Alfred Health in Victoria may be predictive of the need for rehabilitation and length of stay following joint arthroplasty<sup>54,55</sup>.

The layout and access issues within the house (for example, shower hobs, stairs, living areas on upper floors) may need to be addressed, typically by an occupational therapist in the perioperative period if surgery will lead to a temporary functional deficit.

### Perioperative medication management

While detailed medication management is beyond the scope of this chapter, the following are often relevant in the elderly patient:

Perioperative management of anti-platelet and anticoagulation medications depends upon the indication and surgery type and in consultation with the involved specialists. The presence of dual-antiplatelet therapy may contraindicate spinal and certain regional anaesthesia options. Ideally, a documented plan should be given to the patient and outlined in the perioperative medication chart to minimise human factor errors.

As previously suggested, minimise medications that confer a greater risk of delirium, such as new benzodiazepine, antipsychotic and anti-cholinergic medications. The use of multi-modal analgesia to reduce the use of opioids should be considered against the risk from polypharmacy<sup>56</sup>.

Consider the increased risk of orthostatic hypotension and falls with tri-cyclic anti-depressants, first generation antihistamines and anti-cholinergic continence medications<sup>57</sup>. Consider with-holding diuretics or dose adjustment of blood pressure lowering medications if the patient is hypotensive or hypovolemic in the immediate perioperative period.

Beta blockers are generally continued during the perioperative period. While dose reduction could be considered where a patient is hypotensive, sudden cessation should be avoided where possible<sup>58</sup>.

Intraoperative choices: Avoid benzodiazepines where possible to reduce the risk of postoperative delirium and other complications<sup>59</sup>. Ensure judicious, goal-directed fluid management and maintenance of normothermia<sup>60</sup>.

A useful online quick reference resource for perioperative medication management is: <https://www.ukcpa-periophandbook.co.uk>.

### Further investigation

Additional investigation should depend upon identified comorbidity, pre-test probability and its impact on management. Advanced cardiac investigations, such as cardiac echocardiography or stress testing should be requested only if it will inform shared decision making and/or influence perioperative management<sup>61</sup>. Other examples include biochemistry, renal function, HbA1c (for diabetic patients) and haematinics, the latter with a focus on patient blood management principles.

### Formulation: Communication with other perioperative stakeholders including implementation

Formulation of an individual comprehensive geriatric assessment care plan is beyond the scope of this chapter. Adequate "buy-in" and collaboration with other perioperative stakeholders are integral to success. Practical aspects of comprehensive geriatric assessment and subsequent implementation are poorly reported in the literature, likely due to heterogeneity in standardised practice. Much of this may be specific to a given institution or even the perioperative physician/surgeon partnership.

It is important that strategies are in place to ensure recommendations from the assessment are successfully implemented and followed through in the perioperative phase.

### Utility of the comprehensive geriatric assessment in the perioperative setting

The effectiveness of care based around the comprehensive geriatric assessment has been demonstrated in numerous inpatient settings, including dedicated geriatric units and general medical wards<sup>16</sup>. More recently, the comprehensive geriatric assessment has also been applied to the preoperative setting, as outlined below. These results are promising, although more conclusive research is still needed.

Firstly, in terms of the comprehensive geriatric assessment's accuracy in identifying frail patients in the preoperative setting (and therefore those at highest risk of adverse outcomes), studies have found that it was superior to traditional scoring systems such as the ASA and POSSUM<sup>23</sup>. The comprehensive geriatric assessment has also been applied successfully to the surgical oncology population, with a study finding that its' most robust components were activity of daily living, cognition, and depression, when predicting postoperative course<sup>62</sup>.

One of the greatest strengths of the comprehensive geriatric assessment is its potential for intervention and optimisation, and here too, studies in the surgical setting have been promising. For example, the POPS (proactive care of older people undergoing surgery) model<sup>63</sup>, a comprehensive geriatric assessment based service in elective orthopaedic surgery, has demonstrated improved outcomes as a result of multi-disciplinary input, including decreased length of stay, reduced incidence of pressure sores, more satisfactory pain scores and higher rates of early mobilisation. The authors of this study identified that this model helped to recognise issues affecting the perioperative course that were unlikely to have been detected or addressed during a standard preoperative assessment.

Similarly, preoperative comprehensive geriatric assessment was associated with reduced length of stay in a randomised controlled trial on patients undergoing elective vascular surgery<sup>64</sup>. Possible mechanisms for this association include an increased rate of new diagnoses (and therefore appropriate management), medication changes and other interventions such as increased rates of preoperative therapy and social work referral in the intervention group<sup>64</sup>. Moreover, communication with patients and their families was more prevalent in the intervention arm, allowing for better identification of risk factors and shared understanding regarding anticipated postoperative complications.

Mclsaac et al<sup>38</sup> propose that one of the reasons that preoperative geriatric assessment may improve outcomes lies in the holistic approach that guides geriatric medicine. As such, they suggest that this approach better captures the interactions between coexisting medical and functional problems in the elderly, as opposed to the traditional “organ-specific” approach traditionally utilised in the pre-assessment clinic.

However, despite the promising findings outlined above, a systematic review on the impact of a preoperative comprehensive geriatric assessment on outcomes in older patients undergoing elective surgery<sup>65</sup> found that the literature is currently inconclusive, and that the use of CGA in the surgical setting has predominantly been limited to assessment of patients in the absence of any resulting interventions. This may indicate that comprehensive geriatric assessment alone in the preoperative setting is insufficient to improve outcomes without a strategy to integrate the management interventions into the patient’s entire perioperative journey. However, it is noted that the comprehensive geriatric assessment is likely to improve post-operative outcomes in the elderly population, and therefore would still suggest consideration of a multi-disciplinary pathway for such patients. Further research is required to direct these efforts more definitively.

## BARRIERS TO SUCCESSFUL COMPREHENSIVE GERIATRIC ASSESSMENT IMPLEMENTATION

Except for established orthogeriatric services, development of perioperative physician collaboration is still a relatively new and evolving field. Not unlike barriers to ERAS implementation, resistance to new system processes, a lack of awareness of benefit and the need to change existing practice may be potential barriers to successful adoption of comprehensive geriatric assessment as part of perioperative care<sup>66-68</sup>. Similarly, individual or departmental culture beliefs can have a significant influence on behaviour and adoption of perioperative assessment pathways<sup>67-69</sup>.

Rotating medical or nursing staff inexperienced with perioperative care and institutional idiosyncrasies may also impede implementation and can be a common problem within Australia. While there is a paucity of quality evidence that examines the experience of “front line” nursing and resident medical staff implementing recommendations from a preoperative comprehensive geriatric assessment, it is conceivable that problems may arise, and this is an issue that has been identified in the ERAS literature<sup>70</sup>. For example, written correspondence may be filed away or not included in the admitted patient perioperative record. It is therefore imperative that the surgeon, anaesthetist, ward staff and patient are communicating effectively and all are aware of the perioperative recommendations arising from comprehensive geriatric assessment.

Regular education and orientation to perioperative principles for rotating staff and the integration of perioperative care into speciality advanced training curriculum or subspecialty specialisation may ameliorate this. With continued practice, a culture shift may occur such that automated behaviours aligning with best perioperative care and ERAS practice might develop.

Another challenge is the time and cost of comprehensive geriatric assessment which is resource intensive. It is yet another appointment for a patient to attend preoperatively and even with COVID-19 restrictions, not always practical via telehealth. The perioperative physician requires adequate notice in the lead up to surgery and resourcing to assess the patient in a timely fashion before surgery.

## MODELS FOR APPLICATION OF THE COMPREHENSIVE GERIATRIC ASSESSMENT PERIOPERATIVELY

A review of the literature reveals a range of approaches to the use of the comprehensive geriatric assessment in the surgical setting, including which domains it should include, which patients it should be applied to, and who should be involved in the delivery of this service<sup>27,28,56,63,71,72</sup>. While more specific and detailed methods may be of benefit, these obviously come at the cost of being more challenging to implement.

This is most relevant to the elective setting, where time is available between the pre-admission clinic and surgery to allow these interventions to take effect. Nonetheless, early identification of the frail patient in emergency surgery can still help direct anaesthetic management in order to reduce the risk of delirium, ensure adequate hydration and normothermia, and help identify the most appropriate postoperative disposition<sup>60</sup>.

In terms of which patients should have a comprehensive geriatric assessment preoperatively, some authors have taken the approach of applying it to every geriatric patient and those at risk of frailty syndrome<sup>27,56</sup>, while others advocate for its use only in those patients with a positive frailty screening test<sup>28</sup>. Certainly, from a cost-effectiveness and sustainability point of view, the latter would likely be preferable if it can be shown to identify the patients who would best benefit from a comprehensive geriatric assessment. Osborne et al<sup>72</sup> note that geriatric review for all elderly surgical patients is likely unfeasible and instead suggest frailty screening for this purpose.

Given its inherent multidisciplinary nature, ideally a range of interdisciplinary team members should be involved in the use of the comprehensive geriatric assessment perioperatively. This includes anaesthetists, surgeons, geriatricians, physiotherapists, occupational therapists, nutritionists and nursing staff who are integral to perioperative care. The comprehensive geriatric assessment is only one tool in the perioperative armamentarium.

There have been varying approaches regarding the level of involvement by geriatric specialists. Partridge and colleagues<sup>64</sup> found that they were able to utilise their pre-existing services in transitioning to a comprehensive geriatric assessment-based approach through various methods, including educating the pre-admission nursing staff to use the comprehensive geriatric assessment-based screening tool. On the other hand, Mclsaac et al<sup>38</sup> suggest that the involvement of geriatricians in the care of frail perioperative patients is key to the comprehensive geriatric assessment’s success, as geriatricians may be better placed to recognise and respond to risk factors for frailty. Interestingly, a study by Kocman and colleagues<sup>71</sup> that attempted to deliver the comprehensive geriatric assessment in non-geriatrician led preoperative settings (with training and support from geriatricians) delivered disappointing results despite initial enthusiasm. The authors identified challenges to the successful implementation of the intervention such as lack of perceived priority, differences in approach between sites and time pressures (particularly in relation to oncological surgeries with ideal time frames to surgery). Although less favourable from an economic and resources perspective, it is thought that comprehensive geriatric assessment-based initiatives that involve the close involvement of geriatrician support are likely to be more favourable.

Certainly, in the absence of definitive guidelines, the questions of who would benefit from a comprehensive geriatric assessment and who should be involved in its delivery, will need to be guided by the specific resources and limitations of each institution, and the needs and profile of their specific patient population. This planning will also need to involve careful consideration regarding which domains to assess and how to assess them, and will of course also require clear guidelines regarding interventions to target identified deficits<sup>65</sup>.

## OTHER COMPREHENSIVE GERIATRIC ASSESSMENT-BASED INTERVENTIONS

Most people identified with frailty will continue to decline over time. Where present, comprehensive geriatric assessment should identify frailty in the perioperative patient. Multimodal interventions may improve outcomes in the frail older population in reducing cognitive or functional decline although strong evidence specific to the preoperative population is lacking<sup>53</sup>.

## CONSENT AND SHARED DECISION MAKING

The potential impact on quality of life and independence are of particular importance in the elderly population when considering whether or not to proceed with surgery<sup>59</sup>. Through its holistic and individualised assessment, the comprehensive geriatric assessment offers particular benefits in helping guide this shared decision-making process<sup>28,40</sup>. Careful communication of any identified risks can provide patients and their families with realistic expectations and clarify goals of care. This resultant informed decision making may in part explain why some studies have noted that the use of the comprehensive geriatric assessment resulted in some patients opting not to go ahead with surgical management<sup>64,73</sup>.

## PREHABILITATION

There is growing recognition of the potential for “prehabilitation” programs to help optimise patients preoperatively with the aim of reducing adverse postoperative outcomes. It is defined as “any intervention delivered in advance of surgery that improves health, optimises function and/or potentially reduces postoperative risk”<sup>53</sup>. In practice these are programs designed to improve functional, physical and psychological health prior to surgery to lessen the physiological or functional impact of surgery<sup>53,74</sup>. Many components of prehabilitation overlap with ERAS principles such as preoperative education and psychological preparation, optimising medical comorbidity and improving nutrition<sup>53</sup>.

Exercise based intervention is often considered the focus in the perioperative literature. Ideally an exercise program should be individually prescribed for each patient to take into account individual’s impairment(s) and exercise tolerance and occur more than four weeks before surgery<sup>53</sup>. Realistically, the best exercise is one the patient will actually complete. Goals include improved aerobic capacity and muscle strengthening.

However, only a minority of Australian institutions have implemented prehabilitation programs<sup>53,75</sup>. A lack of functional assessment as to whom may benefit, non-standardised perioperative pathways and lack of resources to assess and deliver intervention have been cited as contributory barriers<sup>53</sup>. Privately funded interventions are available such as the GLA:D (Good Life with osteoArthritis: Denmark) program for osteoarthritis for those who are aware and wish to enrol in these programs<sup>76</sup>.

The heterogeneity of patient cohorts, surgery and institutional practice means generalisation is difficult. Composition and efficacy of unimodal exercise intervention is invariably described as an area for further research.

## CONCLUSION

Frailty is increasingly being understood to be an important predictor of perioperative outcomes, as well as a potential target for interventions aimed at risk modification. While the best way of identifying these patients in the preoperative setting is still unclear, easily applied frailty screening tools appear promising in their ability to improve perioperative outcomes in the elderly population. Ongoing work is needed in the Australian setting to tailor optimised pathways for the frail surgical patient. The CGA is an assessment modality that is personalised and holistic for this cohort of often medically complex patients. If challenges surrounding its implementation are tackled, it has the potential to be an integral part of perioperative pathways for the elderly patient that provides opportunities for a collaborative management.

## REFERENCES

1. Welfare AloHa. Older australia at a glance. Canberra: AIHW2018
2. Etzioni DA, Liu JH, Maggard MA, Ko CY. The aging population and its impact on the surgery workforce. *Ann Surg.* 2003; 238(2):170-7.
3. Deiner S, Fleisher LA, Leung JM, Peden C, Miller T, Neuman MD. Adherence to recommended practices for perioperative anesthesia care for older adults among us anesthesiologists: Results from the asa committee on geriatric anesthesia-perioperative brain health initiative asa member survey. *Perioper Med (Lond).* 2020; 9:6.
4. Hamel MB, Henderson WG, Khuri SF, Daley J. Surgical outcomes for patients aged 80 and older: Morbidity and mortality from major noncardiac surgery. *J Am Geriatr Soc.* 2005; 53(3):424-9.
5. Aitken R, Nur-Shirin H, Maier A. Which preoperative screening tool should be applied to older patients undergoing elective surgery to predict short-term postoperative outcomes? Lessons from systematic reviews, meta-analyses and guidelines. *Internal and Emergency Medicine.* 2021; 16(1):37-48.
6. Bilimoria KY, Liu Y, Paruch JL, Zhou L, Kmiecik TE, Ko CY, et al. Development and evaluation of the universal acs nsqip surgical risk calculator: A decision aid and informed consent tool for patients and surgeons. *Journal of the American College of Surgeons.* 2013; 217(5):833-42.e3.
7. Sebastian A, Goyal A, Alvi MA, Wahood W, Elminawy M, Habermann EB, et al. Assessing the performance of national surgical quality improvement program surgical risk calculator in elective spine surgery: Insights from patients undergoing single-level posterior lumbar fusion. *World neurosurgery.* 2019; 126:e323-e9.
8. Wang X, Hu Y, Zhao B, Su Y. Predictive validity of the acs-nsqip surgical risk calculator in geriatric patients undergoing lumbar surgery. *Medicine.* 2017; 96(43):e8416.
9. Paredes A, Katiusha M, Tsilimigras D, Ratti F, Marques H, Beal E, et al. Evaluation of the acs nsqip surgical risk calculator in elderly patients undergoing hepatectomy for hepatocellular carcinoma. *Journal of Gastrointestinal Surgery.* 2020; 24(3):551-9.
10. Marković D, Jevtović-Stoimenov T, Čosić V, Stošić B, Živković B, Janković R. Addition of biomarker panel improves prediction performance of american college of surgeons national surgical quality improvement program (acs nsqip) calculator for cardiac risk assessment of elderly patients preparing for major non-cardiac surgery: A pilot study. *Aging Clinical and Experimental Research.* 2018; 30(5):419-31.
11. Hornor MA, Ma M, Zhou L, Cohen ME, Rosenthal RA, Russell MM, et al. Enhancing the american college of surgeons nsqip surgical risk calculator to predict geriatric outcomes. *Journal of the American College of Surgeons.* 2020; 230(1):88-100.e1.
12. Turrentine FE, Zaydfudim VM, Martin AN, Jones RS. Association of geriatric-specific variables with 30-day hospital readmission risk of elderly surgical patients: A nsqip analysis. *Journal of the American College of Surgeons.* 2020; 230(4):527-33.e1.
13. El-Haddawi F, Abu-Zidan FM, Jones W. Factors affecting surgical outcome in the elderly at auckland hospital. *ANZ J Surg.* 2002; 72(8):537-41.
14. Fried LP, Tangen CM, Walston J, Newman AB, Hirsch C, Gottdiener J, et al. Frailty in older adults: Evidence for a phenotype. *J Gerontol A Biol Sci Med Sci.* 2001; 56(3):M146-56.
15. Robinson TN, Walston JD, Brummel NE, Deiner S, Brown CH, Kennedy M, et al. Frailty for surgeons: Review of a national institute on aging conference on frailty for specialists. *J Am Coll Surg.* 2015; 221(6):1083-92.
16. Ellis G, Whitehead MA, Robinson D, O'Neill D, Langhorne P. Comprehensive geriatric assessment for older adults admitted to hospital: Meta-analysis of randomised controlled trials. *Bmj.* 2011; 343:d6553.
17. Walston J, Hadley EC, Ferrucci L, Guralnik JM, Newman AB, Studenski SA, et al. Research agenda for frailty in older adults: Toward a better understanding of physiology and etiology: Summary from the american geriatrics society/national institute on aging research conference on frailty in older adults. *J Am Geriatr Soc.* 2006; 54(6):991-1001.
18. Rogers MM, Brown R, Stanger MS. Frailty in orthopaedics: Is age relevant? *Injury.* 2020.
19. Clegg A, Young J, Iliffe S, Rikkert MO, Rockwood K. Frailty in elderly people. *Lancet.* 2013; 381(9868):752-62.
20. Amrock LG, Deiner S. Perioperative frailty. *Int Anesthesiol Clin.* 2014; 52(4):26-41.
21. Hewitt J, Long S, Carter B, Bach S, McCarthy K, Clegg A. The prevalence of frailty and its association with clinical outcomes in general surgery: A systematic review and meta-analysis. *Age Ageing.* 2018; 47(6):793-800.
22. Beggs T, Sepehri A, Szwajcer A, Tangri N, Arora RC. Frailty and perioperative outcomes: A narrative review. *Can J Anaesth.* 2015; 62(2):143-57.
23. Dogrul RT, Dogrul AB, Konan A, Caglar O, Sumer F, Caliskan H, et al. Does preoperative comprehensive geriatric assessment and frailty predict postoperative complications? *World J Surg.* 2020; 44(11):3729-36.
24. Makary MA, Segev DL, Pronovost PJ, Syin D, Bandeen-Roche K, Patel P, et al. Frailty as a predictor of surgical outcomes in older patients. *J Am Coll Surg.* 2010; 210(6):901-8.
25. Tjeertes EKM, Fessem JMKv, Mattace-Raso FUS, Hoofwijk AGM, Stolker RJ, Hoeks SE. Influence of frailty on outcome in older patients undergoing non-cardiac surgery - a systematic review and meta-analysis.(report). *Aging and Disease.* 2020; 11(5):1276.
26. Hall DE, Arya S, Schmid KK, Carlson MA, Lavedan P, Bailey TL, et al. Association of a frailty screening initiative with postoperative survival at 30, 180, and 365 days. *JAMA Surg.* 2017; 152(3):233-40.
27. Chow WB, Rosenthal RA, Merkow RP, Ko CY, Esnaola NF. Optimal preoperative assessment of the geriatric surgical patient: A best practices guideline from the american college of surgeons national surgical quality improvement program and the american geriatrics society. *J Am Coll Surg.* 2012; 215(4):453-66.
28. Alvarez-Nebreda ML, Bentov N, Urman RD, Setia S, Huang JC, Pfeifer K, et al. Recommendations for preoperative management of frailty from the society for perioperative assessment and quality improvement (spaqi). *J Clin Anesth.* 2018; 47:33-42.
29. Aucoin DS, Hao IM, Sohi IR, Shaw IJ, Bentov II, Walker ID, et al. Accuracy and feasibility of clinically applied frailty instruments before surgery: A systematic review and meta-analysis. *Anesthesiology.* 2020; 133(1):78-95.
30. Rockwood K, Song X, Macknight C, Bergman H, Hogan DB, McDowell I, et al. A global clinical measure of fitness and frailty in elderly people. *CMAJ : Canadian Medical Association journal = journal de l'Association medicale canadienne.* 2005; 173(5):489.
31. Rolfson DB, Majumdar SR, Tsuyuki RT, Tahir A, Rockwood K. Validity and reliability of the edmonton frail scale. *Age and Ageing.* 2006; 35(5):526-9.
32. Narula S, Lawless A, D'Alessandro P, Jones CW, Yates P, Seymour H. Clinical frailty scale is a good predictor of mortality after proximal femur fracture: A cohort study of 30-day and one-year mortality. *Bone & joint open.* 2020; 1(8):443.
33. Australian and new zealand hip fracture registry annual report of hip fracture care 2020. Sydney: Australian and New Zealand Hip Fracture Registry2020
34. Rockwood Km, Theou OP. Using the clinical frailty scale in allocating scarce health care resources. *Canadian Geriatrics Journal.* 2020; 23(3):254-9.
35. Mclsaac ID, Macdonald BD, Aucoin DS. Frailty for perioperative clinicians: A narrative review. *Anesthesia & Analgesia.* 2020; 130(6):1450-60.
36. Rockwood K, Hogan DB, MacKnight C. Conceptualisation and measurement of frailty in elderly people. *Drugs Aging.* 2000; 17(4):295-302.
37. Subramanian S, Aalberg JJ, Soriano RP, Divino CM. New 5-factor modified frailty index using american college of surgeons nsqip data. *Journal of the American College of Surgeons.* 2018; 226(2):173-81.e8.
38. Mclsaac DI, Jen T, Mookerji N, Patel A, Lalu MM. Interventions to improve the outcomes of frail people having surgery: A systematic review. *PLoS One.* 2017; 12(12):e0190071.
39. Theou O, Brothers TD, Mitnitski A, Rockwood K. Operationalization of frailty using eight commonly used scales and comparison of their ability to predict all-cause mortality. *J Am Geriatr Soc.* 2013; 61(9):1537-51.
40. Bentov I, Kaplan SJ, Pham TN, Reed MJ. Frailty assessment: From clinical to radiological tools. *Br J Anaesth.* 2019; 123(1):37-50.
41. Saedi AA, Feehan J, Phu S, Duque G. Current and emerging biomarkers of frailty in the elderly. *Clin Interv Aging.* 2019; 14:389-98.
42. Charipova K, Urits I, Viswanath O, Urman RD. Preoperative assessment and optimization of cognitive dysfunction and frailty in the ambulatory surgical patient. *Current opinion in anaesthesiology.* 2020; 33(6):732.
43. Gaulton GT, Eckenhoff GR, Neuman DM. Prevalence and multivariable factors associated with preoperative cognitive impairment in outpatient surgery in the united states. *Anesthesia & Analgesia.* 2019; 129(1):e5-e7.
44. Gaulton TG. The older adult with preexisting neurocognitive disorder. *Current opinion in anaesthesiology.* 2019; 32(3):438.
45. Delirium clinical care standard. Sydney: ACSQHC2016
46. Mamtara P, Fortier M, Barnett S, Schmid L, Kain Z. Peri-operative management of frailty in the orthopedic patient. *Journal of Orthopaedics.* 2020; 22:304-7.
47. eTG complete. Melbourne.: Therapeutic Guidelines Ltd.; 2021, March. Pharmacological management for acute behavioural disturbance in older people. Available from: <https://tgldcdp-tg-org-au.smhslibresources.health.wa.gov.au/view/Topic?topicfile=pharmacological-acute-behavioural-disturbance-older-people>.
48. O'Hare K, Brinkmann S, Currigan D. Australasian anaesthesia 2019: Australian and New Zealand College of Anaesthetists; 2019. Postoperative delirium; p. 195-202.
49. St John PD, Hogan DB. The relevance of marjory warren's writings today. *Gerontologist.* 2014; 54(1):21-9.
50. Ellis G, Langhorne P. Comprehensive geriatric assessment for older hospital patients. *Br Med Bull.* 2004; 71:45-59.
51. Department of Health AG. Mbs online: Medicare benefits schedule. Item 141. Canberra: ACT: Commonwealth of Australia; July, 2021.

52. Ljungqvist O, Scott M, Fearon KC. Enhanced recovery after surgery: A review. *JAMA surgery*. 2017; 152(3).
53. Norris MC, Close JTC. Prehabilitation for the frailty syndrome: Improving outcomes for our most vulnerable patients. *Anesthesia & Analgesia*. 2020; 130(6):1524-33.
54. Hlatky MA, Boineau RE, Higginbotham MB, Lee KL, Mark DB, Califf RM, et al. A brief self-administered questionnaire to determine functional capacity (the duke activity status index). *Am J Cardiol*. 1989; 64(10):651-4.
55. Oldmeadow LB, McBurney H, Robertson VJ. Predicting risk of extended inpatient rehabilitation after hip or knee arthroplasty. *J Arthroplasty*. 2003; 18(6):775-9.
56. Aceto P, Antonelli Incalzi R, Bettelli G, Carron M, Chiumiento F, Corcione A, et al. Perioperative management of elderly patients (prime): Recommendations from an italian intersociety consensus. *Aging Clin Exp Res*. 2020; 32(9):1647-73.
57. Knittel JG, Wildes TS. Preoperative assessment of geriatric patients. *Anesthesiol Clin*. 2016; 34(1):171-83.
58. Venkatesan S, Jørgensen ME, Manning HJ, Andersson C, Mozid AM, Coburn M, et al. Preoperative chronic beta-blocker prescription in elderly patients as a risk factor for postoperative mortality stratified by preoperative blood pressure: A cohort study. *Br J Anaesth*. 2019; 123(2):118-25.
59. Anaya DA, Johanning J, Spector SA, Katlic MR, Perrino AC, Feinleib J, et al. *Jama surg*. 149. United States 2014. Summary of the panel session at the 38th annual surgical symposium of the association of va surgeons: What is the big deal about frailty?; p. 1191-7.
60. Griffiths R, Mehta M. Frailty and anaesthesia: What we need to know. *Continuing education in anaesthesia, critical care & pain*. 2014; 14(6):273-7.
61. Barnett S. UpToDate: UpToDate; 2021. Anesthesia for the older adult.
62. Feng MA, McMillan DT, Crowell K, Muss H, Nielsen ME, Smith AB. Geriatric assessment in surgical oncology: A systematic review. *J Surg Res*. 2015; 193(1):265-72.
63. Harari D, Hopper A, Dhese J, Babic-Illman G, Lockwood L, Martin F. Proactive care of older people undergoing surgery ('pops'): Designing, embedding, evaluating and funding a comprehensive geriatric assessment service for older elective surgical patients. *Age Ageing*. 2007; 36(2):190-6.
64. Partridge JS, Harari D, Martin FC, Peacock JL, Bell R, Mohammed A, et al. Randomized clinical trial of comprehensive geriatric assessment and optimization in vascular surgery. *Br J Surg*. 2017; 104(6):679-87.
65. Partridge JS, Harari D, Martin FC, Dhese JK. The impact of pre-operative comprehensive geriatric assessment on postoperative outcomes in older patients undergoing scheduled surgery: A systematic review. *Anaesthesia*. 2014; 69 Suppl 1:8-16.
66. McLeod SR, Aarts SM-A, Chung GF, Eskicioglu AC, Forbes AS, Conn AL, et al. Development of an enhanced recovery after surgery guideline and implementation strategy based on the knowledge-to-action cycle. *Annals of Surgery*. 2015; 262(6):1016-25.
67. Pearsall EA, McLeod RS. Enhanced recovery after surgery: Implementation strategies, barriers and facilitators. *The Surgical clinics of North America*. 2018; 98(6):1201.
68. Pearsall AE, Meghji BZ, Pitzul SK, Aarts SM-A, McKenzie SM, McLeod SR, et al. A qualitative study to understand the barriers and enablers in implementing an enhanced recovery after surgery program. *Annals of Surgery*. 2015; 261(1):92-6.
69. Nadler A, Pearsall EA, Charles Victor J, Aarts M-A, Okrainec A, McLeod RS. Understanding surgical residents' postoperative practices and barriers and enablers to the implementation of an enhanced recovery after surgery (eras) guideline. *Journal of surgical education*. 2014; 71(4):632-8.
70. Kahokehr A, Sammour T, Zargar-Shoshtari K, Thompson L, Hill AG. Implementation of eras and how to overcome the barriers. *International Journal of Surgery*. 2009; 7(1):16-9.
71. Kocman D, Regen E, Phelps K, Martin G, Parker S, Gilbert T, et al. Can comprehensive geriatric assessment be delivered without the need for geriatricians? A formative evaluation in two perioperative surgical settings. *Age Ageing*. 2019; 48(5):644-9.
72. Osborne C, Charles A, Hare A, Thiruchelvam P, Shipway DJH. 10 strategies to increase frailty screening in older surgical inpatients. *Age and Ageing*. 2015; 44(suppl1):i3-i.
73. Brimblecombe CN, Lim WK, Sunderland Y. Preoperative comprehensive geriatric assessment: Outcomes in elective lower limb joint replacement surgery for complex older adults. *J Am Geriatr Soc*. 2014; 62(7):1396-8.
74. Diyana I, Prabir P. *Australasian Anaesthesia 2019: Australian and New Zealand College of Anaesthetists*; 2019. Prehabilitation. p. 289-297.
75. Li M, Bolshinsky V, Ismail H, Burbury K, Ho K, Amin B, et al. A cross-sectional survey of australian anesthetists' and surgeons' perceptions of preoperative risk stratification and prehabilitation. *Canadian Journal of Anesthesia/Journal canadien d'anesthésie*. 2019; 66(4):388-405.
76. Barton CJ, Kemp JL, Roos EM, Skou ST, Dundules K, Pazzinatto MF, et al. Program evaluation of gla:D® australia: Physiotherapist training outcomes and effectiveness of implementation for people with knee osteoarthritis. *Osteoarthritis and Cartilage Open*. 2021; 3(3):100175.

## Perioperative melatonin: Too good to be true?

### Marli Smit MBChB(SA), FCA(SA), MMed Anaes(Stell), PhD

#### Department of Anaesthesia, Sir Charles Gairdner Hospital, Nedlands, Western Australia

Dr Marli Smit graduated as a specialist anaesthetist at Tygerberg Hospital, Stellenbosch University (South Africa) where she also acted as departmental research lead. She obtained a PhD in medical physiology in 2019 and has a special interest in myocardial protection, reperfusion injury, autophagy and melatonin. She is currently doing a research fellowship at Sir Charles Gairdner Hospital.

### Dale Currigan, MBBS(Hons) FANZCA MCLinUS

#### Department of Anaesthesia, Sir Charles Gairdner Hospital, Nedlands, Western Australia

Dr Dale Currigan is a consultant anaesthetist and director of research for the Department of Anaesthesia, Sir Charles Gairdner Hospital, and a senior lecturer at the University of Western Australia. He has broad research and teaching interests including vasopressor pharmacology, ischaemia/reperfusion injury, regional anaesthesia and perioperative echocardiography.

## INTRODUCTION

There is an ongoing search for surgical and anaesthetic approaches, as well as perioperative pharmacological agents, that will further improve perioperative outcomes. The characteristics of the ideal pharmacological agent will include being multi-modal, affordable, accessible and safe.

Melatonin, a hormone released from the pineal gland, regulates circadian rhythms in mammals and plays a potential role in postoperative sleep disturbances, delirium, anxiety, pain, emergence agitation in children and myocardial protection. These effects are as a result of melatonin's important role in regulating the circadian rhythm, as well as its anti-inflammatory and anti-oxidative effects.

This review article will focus on the physiology of melatonin, followed by an overview of the current and potential perioperative uses, dosing, safety and pharmacokinetics.

## PHYSIOLOGY

### Secretion and metabolism of melatonin

Melatonin's (N-acetyl-5-methoxytryptamine) secretion into the blood stream is regulated by the environmental light/dark cycle via the suprachiasmatic nucleus. Light is detected by sensitive ocular photoreceptors which stimulate the formation of melanopsin from photosensitive retinal ganglion cells<sup>1</sup>. Melanopsin then results in melatonin, synthesised from serotonin, which is secreted by the pineal gland<sup>2</sup>. Physiological levels of melatonin, depending on the time of the day, vary between 5 to 200 pg/ml<sup>3</sup>. The precise supratentorial location of action to induce sleep is still unknown<sup>4</sup>.

Extra-pineal tissues that synthesise melatonin include the retina, the innate immune system, ovary and the gastrointestinal tract<sup>5</sup>. However, melatonin produced outside the pineal gland usually does not reach the blood-stream, and is therefore not responsible for any systemic effects<sup>6</sup>. The liver, mitochondria, cytosol, and endoplasmic reticulum are all involved in the metabolism of melatonin<sup>7</sup> to 6-Sulfatoxymelatonin, the main melatonin metabolite.

### Mechanisms of action

Melatonin exerts its physiological actions mainly through five mechanisms:

1. Binding to melatonin receptors in the plasma membrane, cytoplasm and nucleolus.
2. Binding to orphan nuclear receptors.
3. Binding to intracellular proteins such as calcium binding proteins.
4. Antioxidant effect, free radical scavenging<sup>8</sup>.
5. Anti-inflammatory effects.

Human melatonin receptors have been reviewed extensively by Emet et al in 2016<sup>9</sup>. Two membrane receptors (Melatonin receptor 1 and 2, MT<sub>1</sub> and MT<sub>2</sub>), one cytoplasmic receptor (MT<sub>3</sub>) and one nuclear receptor have been identified (see Figure 1)<sup>9</sup>. Both MT<sub>1</sub> and MT<sub>2</sub> belong to G protein-coupled receptors, whereas MT<sub>3</sub> is a

quinone reductase, which inhibits the electron transfer reactions of quinone compounds, and consequently plays an important role in balancing the generation of free radicals. Retinoid-related orphan nuclear hormone receptor (RZR/ROR $\alpha$ ) is the fourth type of melatonin receptor, and is responsible for the regulation of some transcription factors<sup>10</sup>. The locations that melatonin receptors can be found include the brain, retina, cardiac ventricular wall, aorta, coronary and cerebral arteries, liver and gallbladder, duodenal enterocytes, colon, caecum, appendix vermiformis, skin, parotid gland, exocrine pancreas, kidney, cells of immune system, platelets, brown and white adipocytes, epithelial cells of prostate and breast, ovary/granulosa cells, myometrium and placenta<sup>9</sup>. Considering this widespread distribution of receptors, it follows that melatonin may play an important role in various (perioperative) conditions.

**Figure 1. Human melatonin receptors**

MT<sub>1</sub> and MT<sub>2</sub> are membrane bound, MT<sub>3</sub> a cytoplasmic receptor, and RZR a nuclear receptor. Abbreviations: MT, Melatonin; RZR, Retinoid-related orphan nuclear hormone receptor.

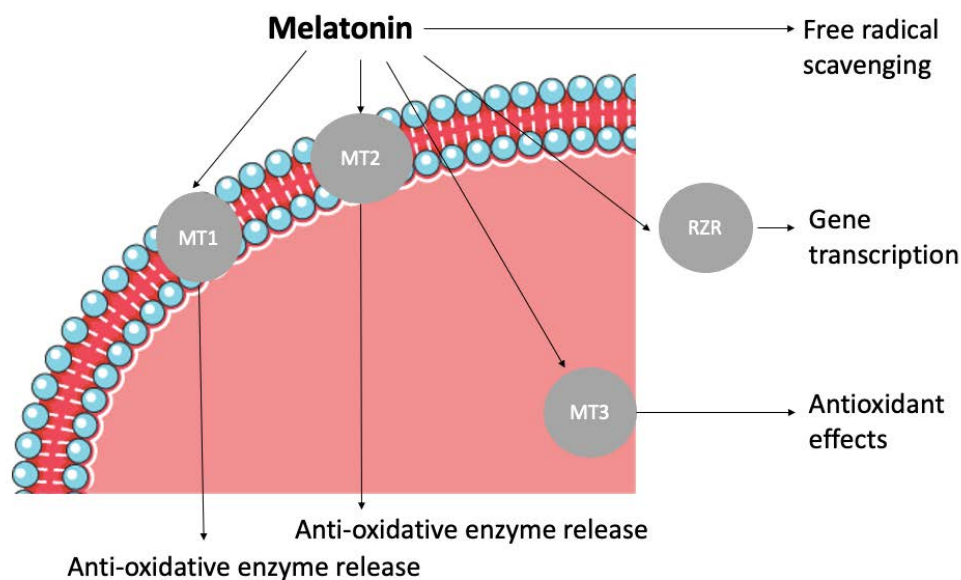

### Antioxidant and free radical scavenger activity of melatonin

The antioxidant effects of melatonin have been demonstrated in various animal studies<sup>11-13</sup> and clinical trials<sup>14,15</sup>.

Three main mechanisms are being proposed to explain the antioxidant and free radical scavenging activity of melatonin:

1. The first is binding of melatonin to the MT<sub>3</sub> receptor which prevents oxidative stress via inhibition of the electron transfer reactions of quinones<sup>16</sup>.
2. Melatonin and its downstream metabolites (N1-acetyl-N2-formyl-5-methoxykynuramine (AFMK) and N-acetyl-5-methoxykynuramine (AMK)) are well-established as powerful direct free radical scavengers via receptor-independent mechanisms<sup>17,18</sup>.
3. Lastly, melatonin also indirectly stimulates antioxidative enzyme release. Enzymes such as glutathione peroxidase, glutathione reductase superoxide dismutase, and glucose-6-phosphate dehydrogenase are being released and consequently lowers molecular damage under conditions of excessive oxidative stress<sup>19</sup>. This stimulation of antioxidative enzymes is mediated by its action on MT<sub>1</sub> and MT<sub>2</sub> receptors.

Due to its highly lipophilic properties, melatonin easily crosses cell membranes and reaches intracellular compartments, including nuclei and mitochondria<sup>20</sup>. The total antioxidant capacity of melatonin, under in vivo and in vitro conditions, seems to be higher than that of other known antioxidants such as vitamin E and vitamin C<sup>21</sup>. One molecule of melatonin can scavenge up to 10 reactive oxygen species (ROS) or reactive nitrogen species (RNS)<sup>17</sup>.

### Anti-inflammatory action of melatonin

The importance of chronic inflammation in overall and especially cardiovascular health, is well established<sup>22-25</sup>.

The immunomodulatory capacity of melatonin, both in vivo and in vitro, has been extensively reviewed before<sup>26</sup>. Melatonin inhibits the expression of inducible nitric oxide synthase (iNOS), cyclooxygenase as well as other inflammatory mediators such as cytokines, chemokines and adhesion molecules<sup>27</sup>. Even though the laboratory evidence for melatonin's anti-inflammatory actions is convincing, the knowledge and evidence directly related to melatonin's effects on the inflammatory response following surgery is still limited.

## CLINICAL USES

### Anxiolysis

The sedative/hypnotic effect associated with melatonin administration is as a result of enhanced gamma-aminobutyric acid (GABA) to GABA-A receptor binding, following brain MT<sub>1</sub> and MT<sub>2</sub> receptor stimulation<sup>28</sup>.

Perioperative anxiety is important to address, as it is unpleasant and may increase postoperative pain<sup>29</sup>. Oral melatonin has been used successfully as a preoperative medication to facilitate anxiolysis and sedation, in both paediatric<sup>30</sup> and adult patients<sup>31-33</sup>. These studies furthermore demonstrated that melatonin premedication, unlike midazolam, does not impair psychomotor skills, result in paradoxical psychological reactions, amnesia, respiratory depression, impact the quality of recovery, or result in a "hangover" effect. Melatonin may thus be considered as a safe and effective alternative to benzodiazepines for preoperative anxiolysis<sup>34</sup>.

A recent Cochrane systematic review (2020) assessing melatonin for treating pre- and postoperative anxiety in adults, included 27 randomised controlled trials (RCTs), and a total of 2319 participants. Doses used ranged from 3-10 mg and were administered via either the oral or sublingual routes. The authors concluded that when compared with placebo, (oral or sublingual) melatonin is superior to placebo as a premedication, in reducing anxiety (when measured 50 to 120 minutes after administration). Melatonin may furthermore have a similar effect to benzodiazepines in reducing preoperative and postoperative anxiety in adults with the added benefit of less adverse effects<sup>35</sup>.

A systematic review on the anaesthetic indications of melatonin in paediatric patients, also published in 2020, included 27 eligible studies. While the significant heterogeneity in study methodology did not allow a quantitative analysis, they still reported that the use of melatonin may decrease the need for, or even replace general anaesthesia for diagnostic procedures; and may serve as an anaesthetic adjunct before induction in paediatric patients<sup>36</sup>.

### Effect of melatonin on anaesthetic induction dose

Four studies have investigated the effect of preoperative melatonin on anaesthetic induction dose. These studies used either bispectral index, clinical assessment or both to determine an adequate induction dose. The melatonin dosages used varied between 3 mg, 5 mg, 9 mg and 0.2 mg/kg<sup>32,33,37,38</sup>.

Three of these studies investigated the effect of melatonin on intravenous anaesthetic dose, and all three concluded that melatonin premedication increases the relative potency of intravenous anaesthetic agents (propofol and thiopentone)<sup>32,33,37</sup>. Melatonin premedication, however, failed to enhance the induction of anaesthesia with sevoflurane<sup>38</sup>.

The possible reduction in dose of intravenous anaesthetic induction agent by melatonin may be as a result of melatonin's action on GABA-A receptors<sup>39</sup>.

### Emergence delirium

Emergence delirium or agitation consist of psychomotor disturbances that occurs most commonly in pre-school children in the early post-anaesthetic period. Although these events are usually short lived, it is perceived as troublesome by 42 per cent of paediatric anaesthetists, it increases the risk of self-injury, delayed discharge, is associated with additional nursing staff and can result in an increase in medical care costs<sup>40</sup>.

Four RCTs (n = 358) studied the effect of preoperative melatonin on prevention of emergence delirium in children. Melatonin was compared with placebo<sup>30,41,42</sup>, dexmedetomidine<sup>41</sup>, ketamine<sup>42</sup> and midazolam<sup>30,41,43</sup>. Postoperative behaviour and agitation was assessed using the Keegan score<sup>43</sup>, a discomfort scale<sup>30</sup> and an agitation scale<sup>41,42</sup>. General anaesthesia was standardised in all four studies, using inhaled sevoflurane. Melatonin (at preoperative dosages ranging between 0.05 to 0.4 mg/kg) was found to be superior to placebo in all four studies<sup>30,41-43</sup>. Melatonin was superior to midazolam in two studies<sup>32,47</sup> and no different in one other<sup>45</sup>, although it should be noted that the evidence for midazolam itself is poor, with a recent meta-analysis of 37 studies showing it has no preventative role in emergence delirium. Other studies reported melatonin to be equally effective to dexmedetomidine<sup>41</sup> and ketamine<sup>42</sup>. Both of these drugs have been shown to decrease the

incidence of emergence delirium in a range of surgical settings<sup>44</sup>. Melatonin has not been compared to other drugs commonly used for prevention of emergence delirium, such as propofol, clonidine or opioids. Kain et al further reported that the beneficial effect of melatonin was dose related; the incidence for agitation after 0.05 mg/kg melatonin was 25 per cent, 8.3 per cent after 0.2 mg/kg melatonin, and the incidence following 0.4 mg/kg melatonin 5.4 per cent<sup>43</sup>.

Ultimately, the current evidence base in the area is small but promising. A systematic review and meta-analysis of existing RCTs investigating the role of preoperative melatonin in emergence delirium concluded that melatonin, compared to placebo, may be effective in preventing emergence delirium in children (low grade evidence). They furthermore reported that high-dose melatonin may be superior to midazolam (very low grade evidence)<sup>45</sup>.

### Acute pain

Melatonin has a promising role as a perioperative analgesic agent. Animal as well as clinical studies have demonstrated dose-dependent antinociception and enhanced postoperative analgesia following systemic melatonin<sup>46-49</sup>. The preoperative anxiolytic and postoperative analgesic effects of melatonin have been compared to those of clonidine<sup>50</sup>. The precise mechanism and site of action of melatonin's antinociception is still unknown. However, interactions with opioid, GABA and NMDA receptor systems have been proposed<sup>51</sup>. The decrease in the release of pro-inflammatory mediators, suppression of nociceptor activation, sleep promotion, free radical scavenging, and nitric oxide synthase inhibition, may also all play a potential role<sup>52-54</sup>.

A meta-analysis of the role of melatonin in postoperative pain (12 RCTs, n = 821) demonstrated that melatonin significantly reduces postoperative pain (reduction in standard mean difference of 1.06 compared to placebo, equivalent to 20 mm on a visual analogue scale)<sup>55</sup>. However, the authors considered the results as unreliable due to the profound heterogeneity of the included studies<sup>55</sup>. They therefore proposed additional RCTs, with specific focus on investigating a variety of melatonin dosages, different routes of administration and timing. This will assist in establishing a dose-response relationship for melatonin, which may be valuable in the clinical setting<sup>55</sup>.

A recent RCT (n = 165), not included in the aforementioned meta-analysis, and the largest RCT with a pain end-point to date, concluded that preoperative oral administration of 6 mg melatonin, in comparison to placebo, led to a significant reduction in pain scores (p < 0.05), total morphine consumption (p = 0.007) and supplemental analgesic requirement (p = 0.001)<sup>56</sup>.

Sleep macrostructure is commonly disturbed after surgery. Given the bidirectional interaction between sleep and pain, a 2019 systematic review examined the role of sleep disturbances during the perioperative period and its relation to postoperative pain<sup>57</sup>. This review included trials investigating the effects of perioperative sleep-promoting pharmacological agents on postoperative pain and analgesic consumption. They concluded that perioperative addition of a sleep-promoting pharmacological agents (like melatonin) may improve pain control, but that underlying evidence is weak and the results inconsistent<sup>57</sup>.

### Postoperative delirium

Postoperative delirium is associated with an increase in morbidity and mortality<sup>58</sup> as well as increased hospital length of stay and healthcare associated costs<sup>59</sup>. Importantly, it is also associated with both short and long term cognitive impairment<sup>60</sup>. Melatonin levels have been shown to decrease following surgery, and delirious patients have lower plasma melatonin concentrations than those who are not delirious<sup>61</sup>. Hence, there has been much interest in the potential role melatonin might play in prevention of postoperative delirium.

To date, the results of trials in both surgical and non-surgical patients have been conflicting, and methodological differences, such as dose, timing, and duration of therapy have made drawing clear conclusions about melatonin's effectiveness difficult.

The most recent systematic review and meta-analysis explored the effect of melatonin and analogues on delirium prevention, and thus delirium incidence, in adult hospitalised patients. Fourteen studies (1712 patients) were included, with melatonin shown to overall significantly reduce delirium incidence (RR 0.61, 95% CI 0.42-0.89, p = 0.009) with a risk reduction of 49 per cent in surgical patients and 34 per cent in ICU patients, although significant heterogeneity was noted (I<sup>2</sup> = 66%). Delirium duration, length of hospital and ICU stay, and mortality were unchanged. Adverse effects (hallucinations, nightmares and gastrointestinal disorders) were also more prevalent in the melatonin group. The optimum dosage, treatment duration, melatonin formulation, and the need for further, larger sample size studies, were again highlighted<sup>62</sup>.

All of the above was supported by an expert update by Scicutella<sup>63</sup>. This update reported that melatonin may play a potential beneficial role in the management of postoperative delirium, but that further clinical trials are required to validate this conclusion<sup>63</sup>.

### Postoperative sleep disturbance

Surgery initially inhibits "rapid eye movement" (REM) sleep, followed by a REM rebound, reduced slow wave sleep and increased duration of light sleep<sup>64</sup>. Melatonin induces sleep and shifts the circadian phase, by the mechanisms described above. A 2005 meta-analysis on the effects of exogenous melatonin on sleep, reported that melatonin treatment increased sleep efficiency, significantly reduced sleep onset latency, and increased total sleep duration<sup>65</sup>. Even though there is theoretical plausibility, there is still limited evidence for the sleep-regulating effect of postoperative melatonin in surgical patients<sup>65</sup>.

A systematic review identified four RCTs (n = 311) that recorded the effect of melatonin on postoperative sleep quality<sup>65</sup>. Sleep was assessed using either sleep questionnaires or accelerography. Melatonin was reported to improve subjective sleep quality in the early postoperative period<sup>49,66</sup> and circadian rhythm during the first postoperative week<sup>47</sup>. In children, melatonin reduced sleep disturbance for two postoperative weeks<sup>30</sup>.

Since the publishing of the above systematic review, two small double blinded, placebo controlled, RCTs in breast surgery patients have additionally shown a beneficial effect on sleep with melatonin. Madsen et al demonstrated melatonin to significantly increase sleep efficiency for the entire two-week postoperative period, without a significant effect on other objective sleep outcomes or on subjective sleep quality (visual analogue scale, and Karolinska Sleepiness Scale)<sup>67</sup>. Hansen et al additionally investigated sleep and postoperative cognitive dysfunction, and concluded that whilst melatonin significantly increased sleep efficiency and total sleep time, it did not affect postoperative cognitive function between the two groups<sup>68</sup>.

A systematic review and meta-analysis explored the influence of melatonin versus placebo on sleep quality, specifically following laparoscopic cholecystectomy. Following the analysis of the results for the five included studies, they concluded that melatonin shows no substantial impact on sleepiness (95% CI=-0.44 to 0.23; P=0.54) or sleep quality (95% CI=-0.21 to 0.41; P=0.53)<sup>69</sup>.

The recent systematic review and meta-analysis by Khaing et al, investigating the effect of melatonin and melatonin receptor agonists on delirium, included secondary outcomes of sleep quality, sedation score and the requirement of sedatives<sup>62</sup>. The supplementation of melatonin, and receptor agonists, were associated with improvement in sleep quality, increased sedation score and lower sedatives consumption<sup>62</sup>.

### Cardiovascular uses of melatonin

A strong inverse relationship exists between endogenous melatonin levels and cardiovascular disease<sup>70</sup>. A review by Jiki et al states that both nocturnal melatonin synthesis and circulating levels are reduced in patients with coronary artery disease, hypertension, heart failure, diabetes and obesity<sup>71</sup>. Further support for the inverse relationship between melatonin and cardiovascular disease is found in the timing of adverse cardiac events. Myocardial infarction<sup>72</sup>, sudden cardiac death<sup>73</sup> and cardiac arrhythmias<sup>74</sup> are all more prevalent in early morning, when circulating melatonin levels are considerably lower<sup>75</sup>.

Table 1 summarises the cardiac conditions and risk factors in which the beneficial effect of melatonin has been reported. For additional detail, as well as the pathways involved, refer to the following recent comprehensive reviews on the role melatonin plays in cardiovascular risk factors and diseases<sup>76-78</sup>.

**Table 1. Cardiac conditions and risk factors in which melatonin plays a favourable role**

Cardiac condition or risk factor	Effect of melatonin	Reference(s)
Metabolic syndrome <ul style="list-style-type: none"> <li>▪ Glucose regulation</li> <li>▪ Dyslipidaemia</li> <li>▪ Obesity</li> </ul>	An increase in melatonin levels results in a down-regulation of insulin secretion. Melatonin additionally regulates dyslipidaemia and has anti-obesity effects.	78-86
Hypertension	Antihypertensive.	87-89
Arrhythmias	Anti-arrhythmic.	90,91
Atherosclerosis	Effective in the treatment of atherosclerosis (only animal studies).	92,93
Pulmonary hypertension	Reduction in pulmonary pressures via antioxidant, anti-inflammatory, and vasodilatory mechanisms.	94,95



Platelet aggregation	Reduction in platelet aggregation and reactivity.	21
Microcirculation	Protection of the microcirculation and endothelial function.	96,97
Myocardial ischemia/ reperfusion (I/R) injury	Protection against the detrimental effects of I/R injury.	90,98-100

The mechanisms by which melatonin provides cardioprotection against I/R injury are complex and multifactorial. Melatonin may directly and indirectly reduce reperfusion injury via immunomodulatory activities and a reduction in oxidative stress<sup>98</sup>, apoptosis<sup>101,102</sup>, necrosis, mitochondrial permeability transition pore opening<sup>103</sup>, lipid peroxidation and inflammation. There is also accumulating evidence of the beneficial role melatonin plays in the regulation and restoration of damaged autophagic processes<sup>104</sup>. To date, few and conflicting clinical trials have investigated the effect of exogenous melatonin as a therapeutic agent during I/R injury<sup>105-114</sup>.

In addition, as summarised in reviews by Lochner et al and Imenshahidi et al, melatonin treatment can also protect the heart against damage induced by chronic intermittent hypoxia, angiotensin II, isoproterenol, epinephrine, doxorubicin, aluminium phosphide-induced cardiotoxicity, 2,3,7,8-tetrachlorodibenzo-p-dioxin, elevated heart rate, and postural tachycardia syndrome<sup>77,78</sup>.

Following all of above, Sun et al pointed out that melatonin, an inexpensive and well tolerated drug, needs to be considered as a novel therapeutic option in cardiovascular disease<sup>76</sup>. Melatonin may have perioperative cardiovascular value with regards to preoperative risk factor modification, as well as intraoperative and postoperative myocardial protection.

#### General (potential) clinical uses

Growing evidence supports the other beneficial multi-organ effects of melatonin, as extensively reviewed previously<sup>4,115</sup>. The therapeutic potential of melatonin includes metabolic disorders<sup>116</sup>, various cancers<sup>117</sup>, neurodegenerative diseases<sup>118</sup>, reproductive diseases<sup>119</sup>, bone diseases (osteopenia, osteoporosis, and periodontal disease)<sup>120</sup>, eye (macular degeneration, glaucoma)<sup>121</sup> and skin diseases<sup>122</sup>.

## DOSAGE AND SAFETY

In Australia the only licenced formulation of melatonin is Circadin, a 2 mg, slow-release preparation. Immediate release melatonin is available in liquid and capsule form from hospital and community compounding pharmacies.

#### Dosage

Endogenous melatonin levels are a well-established determinant of total antioxidant capacity as well as inflammatory response<sup>98,114</sup>. The reported dose of oral melatonin has ranged from 0.05 mg/kg<sup>116</sup> to dosages as high as 300 mg/day for up to two years<sup>123</sup>.

Previous clinical studies made use of arbitrarily chosen melatonin dosages, mainly based on safety considerations<sup>107</sup>. The inconsistencies in clinical studies regarding melatonin's perioperative beneficial effects may be as a result of the discrepancy in dosages (ranging between fixed dosages of 3 mg to 50 mg and 0.05-0.5mg/kg), the mode (oral, intravenous or sublingual), duration of administration as well as the timing of administration. Previous studies reported the effective melatonin dosage to reduce oxidative stress, related to a surgical procedure, to be as high as 10 mg/kg<sup>124-126</sup>. On average the melatonin dose used in the clinical studies are however significantly lower than those used in the experimental models<sup>115</sup>. Dwaich et al furthermore demonstrated the importance of melatonin dosing by reporting on the dose dependant decrease in troponin and inflammatory markers following cardiac surgery<sup>109</sup>.

#### Safety

The majority of clinical trials, as reviewed by two review articles, have shown very low melatonin toxicity<sup>55,115,127</sup>. In a phase I dose escalation study to assess the tolerability and pharmacokinetics in healthy volunteers, no adverse effects were noticed following the oral doses of 20, 30, 50, and 100 mg of melatonin<sup>21,128</sup>. Dosages up to 10 mg/kg has been reported to be safe in neonates<sup>125</sup> and treatment of patients undergoing major aortic surgery with intravenous melatonin of up to 60 mg in the intraoperative phase was safe and without complications<sup>129</sup>.

Finally, the therapeutic goods administration (TGA) of Australia concluded that "adverse events of any kind were no more common under circadian therapy than with placebo... No clinically significant changes were found under circadian treatment in laboratory parameters, physical examination or vital signs. There was no data to suggest withdrawal or rebound phenomena..."<sup>130</sup>.

Adverse effects because of melatonin are generally minor, short-lived and include fatigue, mood change, headache, pharyngitis, back pain, asthenia and a decrease in neurocognitive performance. It is reasonable to

conclude that the safety profile of oral melatonin supplementation in humans is very favourable, especially when dosing in accordance with natural circadian rhythms<sup>131</sup>.

#### Pharmacokinetics of melatonin

Melatonin is completely absorbed when administered orally, although its absolute bioavailability is only 3-33 per cent due to an 85 per cent first pass metabolism by the liver<sup>132</sup>. Following absorption from the small intestine, by first-order kinetics the time to maximum concentration (T<sub>max</sub>) is achieved after approximately 30-45 minutes<sup>132</sup>. Oral administration 45 minutes before intended effects are thus advocated if assuming that clinical efficacy coincides with T<sub>max</sub> values. The half-life of melatonin is 40-60 minutes, which implies that this drug will stay in the body for about five hours. Elimination of the drug occurs largely through renal excretion of metabolites<sup>133</sup>.

Only a limited number of studies have been performed investigating the pharmacokinetic properties in humans. These studies typically only involve young healthy subjects. In these studies, even though an identical dosing regimen was followed, a substantial intra-study variation was demonstrated between subjects, in terms of oral bioavailability and maximum concentration<sup>132</sup>. For example, following 10 mg of oral melatonin, maximal plasma levels ranged between 1105 and 58,900 pg/ml<sup>133</sup>. The cause for this extreme variability may be as a result to interindividual differences in absorption, distribution, metabolism, and elimination of the drug<sup>132,134</sup>.

Other factors potentially influencing the variability in melatonin levels (and thus study results) include<sup>130</sup>:

1. Gender: A three-to-four-fold increase in maximum concentration is apparent for women compared to men.
2. Elderly: Melatonin metabolism declines with age, and higher levels have been reported in older subjects compared to younger subjects. Advancing age has also been shown to affect the absorption of oral melatonin. Clinical data shows a reduction in oral absorption by up to 50 per cent in elderly patients.
3. Liver function: Hepatic impairment results in higher endogenous melatonin levels since the liver is the primary site of melatonin metabolism.
4. Diet: Consumption of melatonin-rich foods such as grape juice, wine, cereals, tropical fruits and walnuts increases baseline circulating melatonin levels<sup>71</sup>.
5. Underlying diseases: As mentioned before, patients with ischemic heart disease, hypertension, heart failure, advanced diabetes and obesity all have a decrease in endogenous melatonin levels<sup>70,71</sup>.

Above mentioned variations in pharmacokinetics (due to different formulations, patient populations, routes of administration and dosing) make it difficult to compare and interpret results from different trials. In addition, plasma melatonin levels vary extensively within studies, even with identical dosages. These substantial differences may potentially impact clinical efficacy, which makes it imperative to correlate clinical effects and actual plasma melatonin levels following exogenous melatonin administration<sup>133</sup>.

## CONCLUSION

Despite a strong theoretical basis for a multi-modal, positive, perioperative role, there are conflicting study results in the literature regarding the perioperative role of melatonin. It is likely that heterogeneity in study methodology is the cause for the discrepancies between study results. The paucity of data on melatonin dosing means that choice of dose, timing, route of administration and duration of therapy vary greatly between study protocols. As such, there is a critical need for dose response studies, and how dose correlates with plasma melatonin levels. Additionally, larger studies investigating the optimal route, timing and duration of administration are required.

Notwithstanding these issues, the case for perioperative melatonin does continue to grow. Most studies do support melatonin as a pre-medication, alone or in combination with other standard drugs. Other positive effects include better recovery of circadian rhythm, a role in prevention of postoperative delirium and emergence agitation, and a reduction in the need for other anaesthetic and analgesic drugs. Melatonin's favourable safety profile, affordability and accessibility further add to its enormous potential clinical benefit.

## REFERENCES

1. Gooley JJ, Lu J, Fischer D, Saper CB. A broad role for melanopsin in nonvisual photoreception. *J Neurosci*. 2003 Aug;23(18):7093-106.
2. Cahill GM, Grace MS, Besharse JC. Rhythmic regulation of retinal melatonin: metabolic pathways, neurochemical mechanisms, and the ocular circadian clock. *Cell Mol Neurobiol*. 1991 Oct;11(5):529-60.
3. Hickie IB, Rogers NL. Novel melatonin-based therapies: potential advances in the treatment of major depression. *Lancet*. 2011 Aug;378(9791):621-31.
4. Opie LH, Lecour S. Melatonin has multiorgan effects. *Eur Heart J Cardiovasc Pharmacother*. 2016 Oct;2(4):258-65.

5. Jockers R, Delagrance P, Dubocovich ML, Markus RP, Renault N, Tosini G, et al. Update on melatonin receptors: IUPHAR Review 20. *Br J Pharmacol*. 2016 Sep;173(18):2702–25.
6. Bubenik GA, Pang SF. The role of serotonin and melatonin in gastrointestinal physiology: ontogeny, regulation of food intake, and mutual serotonin-melatonin feedback. *J Pineal Res*. 1994 Mar;16(2):91–9.
7. Slominski AT, Semak I, Fischer TW, Kim TK, Kleszczynski K, Hardeland R, et al. Metabolism of melatonin in the skin: why is it important? *Exp Dermatol*. 2017 Jul;26(7):563–8.
8. Zhang HM, Zhang Y. Melatonin: a well-documented antioxidant with conditional pro-oxidant actions. *J Pineal Res*. 2014 Sep;57(2):131–46.
9. Emet M, Ozcan H, Ozel L, Yayla M, Halici Z, Hacimuftuoglu A. A review of melatonin, its receptors and drugs. *Eurasian J Med*. 2016 Jun;48(2):135–41.
10. Pandi-Perumal SR, Trakht I, Srinivasan V, Spence DW, Maestroni GJ, Zisapel N, et al. Physiological effects of melatonin: role of melatonin receptors and signal transduction pathways. *Prog Neurobiol*. 2008 Jul;85(3):335–53.
11. Djordjevic B, Cvetkovic T, Stoimenov TJ, Despotovic M, Zivanovic S, Basic J, et al. Oral supplementation with melatonin reduces oxidative damage and concentrations of inducible nitric oxide synthase, VEGF and matrix metalloproteinase 9 in the retina of rats with streptozotocin/nicotinamide induced pre-diabetes. *Eur J Pharmacol*. 2018 Aug;833:290–7.
12. Gerush IV, Bevo VV, Ferenchuk YO. The effect of melatonin on lipid peroxide oxidation, oxidative modification of proteins and mitochondria swelling in the skeletal muscle tissue of rats under alloxan diabetes. *Ukr Biochem J*. 2018 Jun;90(3):62–9.
13. Kurhaluk N, Bojkova B, Radkowski M, Zaitseva OV, Kyriienko S, Demkow U, et al. Melatonin and metformin diminish oxidative stress in heart tissue in a rat model of high fat diet and mammary carcinogenesis. *Adv Exp Med Biol*. 2018;1047:7–19.
14. Rybka J, Kędziora-Kornatowska K, Kupczyk D, Muszaliak M, Kornatowski M, Kędziora J. Antioxidant effect of immediate-versus sustained-release melatonin in type 2 diabetes mellitus and healthy controls. *Drug Deliv*. 2016;23(3):814–7.
15. Raygan F, Ostadmohammadi V, Bahmani F, Reiter RJ, Asemi Z. Melatonin administration lowers biomarkers of oxidative stress and cardio-metabolic risk in type 2 diabetic patients with coronary heart disease: a randomized, double-blind, placebo-controlled trial. *Clin Nutr*. 2019 Feb;38(1):191–6.
16. Nosjean O, Ferro M, Cogé F, Beauverger P, Henlin JM, Lefoulon F, et al. Identification of the melatonin-binding site MT3 as the quinone reductase 2. *J Biol Chem*. 2000 Oct;275(40):31311–7.
17. Tan DX, Manchester LC, Terron MP, Flores LJ, Reiter RJ. One molecule, many derivatives: a never-ending interaction of melatonin with reactive oxygen and nitrogen species? *J Pineal Res*. 2007 Jan;42(1):28–42.
18. Reiter RJ, Mayo JC, Tan DX, Sainz RM, Alatorre-Jimenez M, Qin L. Melatonin as an antioxidant: under promises but over delivers. *J Pineal Res*. 2016 Oct;61(3):253–78.
19. Reiter RJ, Tan DX. Melatonin: a novel protective agent against oxidative injury of the ischemic/reperfused heart. *Cardiovasc Res*. 2003 Apr;58(1):10–9.
20. Acuña-Castroviejo D, Escames G, Venegas C, Diaz-Casado ME, Lima-Cabello E, López LC, et al. Extrapineal melatonin: sources, regulation, and potential functions. *Cell Mol Life Sci*. 2014 Aug;71(16):2997–3025.
21. Pandi-Perumal SR, BaHammam AS, Ojike NI, Akinseye OA, Kendzerska T, Buttoo K, et al. Melatonin and human cardiovascular disease. *J Cardiovasc Pharmacol Ther*. 2017 Mar;22(2):122–32.
22. Furman D, Campisi J, Verdin E, Carrera-Bastos P, Targ S, Franceschi C, et al. Chronic inflammation in the etiology of disease across the life span. *Nat Med*. 2019 Dec;25(12):1822–32.
23. Yellon DM, Hausenloy DJ. Myocardial reperfusion injury. *N Engl J Med*. 2007 Sep;357(11):1121–35.
24. Turer AT, Hill JA. Pathogenesis of myocardial ischemia-reperfusion injury and rationale for therapy. *Am J Cardiol*. 2010 Aug;106(3):360–8.
25. Frank A, Bonney M, Bonney S, Weitzel L, Koeppen M, Eckle T. Myocardial ischemia reperfusion injury: from basic science to clinical bedside. *Semin Cardiothorac Vasc Anesth*. 2012 Sep;16(3):123–32.
26. Mauriz JL, Collado PS, Veneroso C, Reiter RJ, González-Gallego J. A review of the molecular aspects of melatonin's anti-inflammatory actions: recent insights and new perspectives. *J Pineal Res*. 2013 Jan;54(1):1–14.
27. Chuang JI, Mohan N, Meltz ML, Reiter RJ. Effect of melatonin on NF- $\kappa$ -B DNA-binding activity in the rat spleen. *Cell Biol Int*. 1996 Oct;20(10):687–92.
28. Roth T, Nir T, Zisapel N. Prolonged release melatonin for improving sleep in totally blind subjects: a pilot placebo-controlled multicenter trial. *Nat Sci Sleep*. 2015 Jan;7:13–23.
29. Caumo W, Schmidt AP, Schneider CN, Bergmann J, Iwamoto CW, Adamatti LC, et al. Risk factors for postoperative anxiety in adults. *Anaesthesia*. 2001 Aug;56(8):720–8.
30. Samarkandi A, Naguib M, Riad W, Thalaj A, Alotibi W, Aldammam F, et al. Melatonin vs. midazolam premedication in children: a double-blind, placebo-controlled study. *Eur J Anaesthesiol*. 2005 Mar;22(3):189–96.
31. Naguib M, Samarkandi AH. The comparative dose-response effects of melatonin and midazolam for premedication of adult patients: a double-blinded, placebo-controlled study. *Anesth Analg*. 2000 Aug;91(2):473–9.
32. Naguib M, Samarkandi AH, Moniem MA, Mansour ED, Alshaer AA, Al-Ayyaf HA, et al. The effects of melatonin premedication on propofol and thiopental induction dose-response curves: a prospective, randomized, double-blind study. *Anesth Analg*. 2006 Dec;103(6):1448–52.
33. Norouzi A, Fateh S, Modir H, Kamali A, Akrami L. Premedication effect of melatonin on propofol induction dose for anesthesia, anxiety, orientation and sedation after abdominal surgery: a double-blinded randomized trial. *Med Gas Res*. 2019 Apr-Jun;9(2):62–7.
34. Maitra S, Baidya DK, Khanna P. Melatonin in perioperative medicine: current perspective. *Saudi J Anaesth*. 2013 Jul;7(3):315–21.
35. Madsen BK, Zetner D, Møller AM, Rosenberg J. Melatonin for preoperative and postoperative anxiety in adults. *Cochrane Database Syst Rev*. 2020 Dec;12(12):CD009861.

36. Procaccini D, Lobner K, Azamfirei R, Kudchadkar SR. Melatonin for anaesthetic indications in paediatric patients: a systematic review. *Anaesthesia*. 2021 Jun;76(6):837–49.
37. Turkistani A, Abdullah KM, Al-Shaer AA, Mazen KF, Alkatheri K. Melatonin premedication and the induction dose of propofol. *Eur J Anaesthesiol*. 2007 May;24(5):399–402.
38. Evagelidis P, Paraskeva A, Petropoulos G, Staikou C, Fassoulaki A. Melatonin premedication does not enhance induction of anaesthesia with sevoflurane as assessed by bispectral index monitoring. *Singapore Med J*. 2009 Jan;50(1):78–81.
39. Wang F, Li J, Wu C, Yang J, Xu F, Zhao Q. The GABA(A) receptor mediates the hypnotic activity of melatonin in rats. *Pharmacol Biochem Behav*. 2003 Feb;74(3):573–8.
40. Moore AD, Angheliescu DL. Emergence Delirium in Pediatric Anesthesia. *Paediatr Drugs*. 2017 Feb;19(1):11–20.
41. Özcengiz D, Gunes Y, Ozmete O. Oral melatonin, dexmedetomidine, and midazolam for prevention of postoperative agitation in children. *J Anesth*. 2011 Apr;25(2):184–8.
42. Khalifa OS, Hassnan AA. Melatonin, ketamine and their combination in half doses for management of sevoflurane agitation in children undergoing adenotonsillectomy. *Egypt J Anaesth*. 2013;29(4):337–41.
43. Kain ZN, MacLaren JE, Herrmann L, Mayes L, Rosenbaum A, Hata J, et al. Preoperative melatonin and its effects on induction and emergence in children undergoing anaesthesia and surgery. *Anesthesiology*. 2009 Jul;111(1):44–9.
44. Mason KP. Paediatric emergence delirium: a comprehensive review and interpretation of the literature. *Br J Anaesth*. 2017 Mar;118(3):335–43.
45. Mihara T, Nakamura N, Ka K, Oba MS, Goto T. Effects of melatonin premedication to prevent emergence agitation after general anaesthesia in children: a systematic review and meta-analysis with trial sequential analysis. *Eur J Anaesthesiol*. 2015 Dec;32(12):862–17.
46. Yu CX, Zhu B, Xu SF, Cao XD, Wu GC. The analgesic effects of peripheral and central administration of melatonin in rats. *Eur J Pharmacol*. 2000 Sep;403(1-2):49–53.
47. Caumo W, Torres F, Moreira NL Jr, Auzani JA, Monteiro CA, Londero G, et al. The clinical impact of preoperative melatonin on postoperative outcomes in patients undergoing abdominal hysterectomy. *Anesth Analg*. 2007 Nov;105(5):1263–71.
48. Ismail SA, Mowafi HA. Melatonin provides anxiolysis, enhances analgesia, decreases intraocular pressure, and promotes better operating conditions during cataract surgery under topical anesthesia. *Anesth Analg*. 2009 Apr;108(4):1146–51.
49. Borazan H, Tuncer S, Yalcin N, Erol A, Otelcioglu S. Effects of preoperative oral melatonin medication on postoperative analgesia, sleep quality, and sedation in patients undergoing elective prostatectomy: a randomized clinical trial. *J Anesth*. 2010 Apr;24(2):155–60.
50. Caumo W, Levandovski R, Hidalgo MP. Preoperative anxiolytic effect of melatonin and clonidine on postoperative pain and morphine consumption in patients undergoing abdominal hysterectomy: a double-blind, randomized, placebo-controlled study. *J Pain*. 2009 Jan;10(1):100–8.
51. Mowafi H, Ismail S. The uses of melatonin in anesthesia and surgery. *Saudi J Med Med Sci*. 2014;2(3):134–41.
52. Srinivasan V, Pandi-Perumal SR, Spence DW, Moscovitch A, Trakht I, Brown GM, et al. Potential use of melatonergic drugs in analgesia: mechanisms of action. *Brain Res Bull*. 2010 Mar;81(4-5):362–71.
53. Shavali S, Ho B, Govitrapong P, Sawlom S, Ajijmaporn A, Klongpanichapak S, et al. Melatonin exerts its analgesic actions not by binding to opioid receptor subtypes but by increasing the release of beta-endorphin an endogenous opioid. *Brain Res Bull*. 2005 Jan;64(6):471–9.
54. Esposito E, Paterniti I, Mazzon E, Bramanti P, Cuzzocrea S. Melatonin reduces hyperalgesia associated with inflammation. *J Pineal Res*. 2010 Nov;49(4):321–31.
55. Andersen LP, Werner MU, Rosenberg J, Gögenur I. A systematic review of peri-operative melatonin. *Anaesthesia*. 2014 Oct;69(10):1163–71.
56. Laflı Tunay D, Türkeün İlginel M, Ünlügenç H, Tunay M, Karacaer F, Biricik E. Comparison of the effects of preoperative melatonin or vitamin C administration on postoperative analgesia. *Bosn J Basic Med Sci*. 2020 Feb;20(1):117–24.
57. Bjurström MF, Irwin MR. Perioperative pharmacological sleep-promotion and pain control: a systematic review. *Pain Pract*. 2019 Jun;19(5):552–69.
58. Bellelli G, Mazzola P, Morandi A, Bruni A, Carnevali L, Corsi M, et al. Duration of postoperative delirium is an independent predictor of 6-month mortality in older adults after hip fracture. *J Am Geriatr Soc*. 2014 Jul;62(7):1335–40.
59. Australian Commission on Safety and Quality in Health Care. Delirium clinical care [Internet]. Sydney: ACSQHC; 2016 Jul [cited 2021 Apr 15]. 31p. Available from: <https://www.safetyandquality.gov.au/sites/default/files/migrated/Delirium-Clinical-Care-Standard-Web-PDF.pdf>
60. Pandharipande PP, Girard TD, Jackson JC, Morandi A, Thompson JL, Pun BT, et al. Long-term cognitive impairment after critical illness. *N Engl J Med*. 2013 Oct;369(14):1306–16.
61. Shigetani H, Yasui A, Nimura Y, Machida N, Kageyama M, Miura M, et al. Postoperative delirium and melatonin levels in elderly patients. *Am J Surg*. 2001 Nov;182(5):449–54.
62. Khaing K, Nair BR. Melatonin for delirium prevention in hospitalized patients: a systematic review and meta-analysis. *J Psychiatr Res*. 2021 Jan;133:181–90.
63. Scicutella A. The pharmacotherapeutic management of postoperative delirium: an expert update. *Expert Opin Pharmacother*. 2020 Jun;21(8):905–16.
64. Gögenur I, Wildschödtz G, Rosenberg J. Circadian distribution of sleep phases after major abdominal surgery. *Br J Anaesth*. 2008 Jan;100(1):45–9.
65. Brzezinski A, Vangel MG, Wurtman RJ, Norrie G, Zhdanova I, Ben-Shushan A, et al. Effects of exogenous melatonin on sleep: a meta-analysis. *Sleep Med Rev*. 2005 Feb;9(1):41–50.
66. Gögenur I, Küçükakin B, Bisgaard T, Kristiansen V, Hjortso NC, Skene DJ, et al. The effect of melatonin on sleep quality after laparoscopic cholecystectomy: a randomized, placebo-controlled trial. *Anesth Analg*. 2009 Apr;108(4):1152–6.

67. Madsen MT, Hansen MV, Andersen LT, Hageman I, Rasmussen LS, Bokmand S, et al. Effect of melatonin on sleep in the perioperative period after breast cancer surgery: a randomized, double-blind, placebo-controlled trial. *J Clin Sleep Med*. 2016 Feb;12(2):225–33.
68. Hansen MV, Madsen MT, Andersen LT, Hageman I, Rasmussen LS, Bokmand S, et al. Effect of melatonin on cognitive function and sleep in relation to breast cancer surgery: a randomized, double-blind, placebo-controlled trial. *Int J Breast Cancer* [Internet]. 2014 Aug [cited 2021 March 10] 2014:416531. Available from: <https://pubmed.ncbi.nlm.nih.gov/25328711/>. doi: 10.1155/2014/416531
69. Zhang J, Wang Y, Xu H, Yang J. The influence of melatonin on sleep quality after laparoscopic cholecystectomy: a meta-analysis of randomized controlled trials. *Surg Laparosc Endosc Percutan Tech*. 2019; Feb;29(1):1–6.
70. Dominguez-Rodriguez A, Abreu-Gonzalez P, Sanchez-Sanchez JJ, Kaski JC, Reiter RJ. Melatonin and circadian biology in human cardiovascular disease. *J Pineal Res*. 2010 Aug;49(1):14–22.
71. Jiki Z, Lecour S, Nduhirabandi F. Cardiovascular benefits of dietary melatonin: a myth or a reality? *Front Physiol* [Internet]. 2018 May [cited 2021 March 21];9:528. Available from: <https://pubmed.ncbi.nlm.nih.gov/29867569/>. doi: 10.3389/fphys.2018.00528
72. Dominguez-Rodríguez A, Abreu-González P, García MJ, Sanchez J, Marrero F, de Armas-Trujillo D. Decreased nocturnal melatonin levels during acute myocardial infarction. *J Pineal Res*. 2002 Nov;33(4):248–52.
73. Muller JE, Ludmer PL, Willich SN, Tofler GH, Aylmer G, Kiangos I, et al. Circadian variation in the frequency of sudden cardiac death. *Circulation*. 1987 Jan;75(1):131–8.
74. Siegel D, Black DM, Seeley DG, Hulley SB. Circadian variation in ventricular arrhythmias in hypertensive men. *Am J Cardiol*. 1992 Feb;69(4):344–7.
75. Yaprak M, Altun A, Vardar A, Aktöz M, Ciftçi S, Ozbay G. Decreased nocturnal synthesis of melatonin in patients with coronary artery disease. *Int J Cardiol*. 2003 May;89(1):103–7.
76. Sun H, Gusdon AM, Qu S. Effects of melatonin on cardiovascular diseases: progress in the past year. *Curr Opin Lipidol*. 2016 Aug;27(4):408–13.
77. Lochner A, Marais E, Huisamen B. Melatonin and cardioprotection against ischaemia/reperfusion injury: what's new? *A review*. *J Pineal Res* [Internet]. 2018 Aug [cited 2020 Nov 11];65(1):e12490. Available from: <https://pubmed.ncbi.nlm.nih.gov/29570845/>. doi: 10.1111/jpi.12490
78. Imenshahidi M, Karimi G, Hosseinzadeh H. Effects of melatonin on cardiovascular risk factors and metabolic syndrome: a comprehensive review. *Naunyn Schmiedeberg's Arch Pharmacol*. 2020 Apr;393(4):521–36.
79. Ríos-Lugo MJ, Cano P, Jiménez-Ortega V, Fernández-Mateos MP, Scacchi PA, Cardinali DP, et al. Melatonin effect on plasma adiponectin, leptin, insulin, glucose, triglycerides and cholesterol in normal and high fat-fed rats. *J Pineal Res*. 2010 Nov;49(4):342–8.
80. Koziróg M, Poliwczak AR, Duchnowicz P, Koter-Michalak M, Sikora J, Broncel M. Melatonin treatment improves blood pressure, lipid profile, and parameters of oxidative stress in patients with metabolic syndrome. *J Pineal Res*. 2011 Apr;50(3):261–6.
81. Salari Lak L, Heidari R, Nejati V. Protective effects of melatonin on lipid profile in fructose induced dyslipidemia. *Iran J Endocrinol Metab*. 2011 Nov;13(4):406–11.
82. Peschke E, Bähr I, Mühlbauer E. Melatonin and pancreatic islets: interrelationships between melatonin, insulin and glucagon. *Int J Mol Sci*. 2013 Mar;14(4):6981–7015.
83. Lardone PJ, Alvarez-Sanchez SN, Guerrero JM, Carrillo-Vico A. Melatonin and glucose metabolism: clinical relevance. *Curr Pharm Des*. 2014;20(30):4841–53.
84. Nduhirabandi F, Huisamen B, Strijdom H, Lochner A. Role of melatonin in glucose uptake by cardiomyocytes from insulin-resistant Wistar rats. *Cardiovasc J S Afr*. 2017 Nov/Dec;28(6):362–9.
85. Ahmad Hajam Y, Rai S, Basheer M, Ghosh H, Singh S. Protective role of melatonin in streptozotocin induced pancreatic damages in diabetic Wistar rat. *Pak J Biol Sci*. 2018 Jan;21(9):423–31.
86. Santos RM, Marani F, Chiba FY, Mattera MS, Tsosura TV, Tessarin GW, et al. Melatonin promotes reduction in TNF levels and improves the lipid profile and insulin sensitivity in pinealectomized rats with periodontal disease. *Life Sci*. 2018 Nov;213:32–9.
87. Hung MW, Kravtsov GM, Lau CF, Poon AM, Tipoe GL, Fung ML. Melatonin ameliorates endothelial dysfunction, vascular inflammation, and systemic hypertension in rats with chronic intermittent hypoxia. *J Pineal Res*. 2013 Oct;55(3):247–56.
88. Klimentova J, Cebova M, Barta A, Matuskova Z, Vrankova S, Rehakova R, et al. Effect of melatonin on blood pressure and nitric oxide generation in rats with metabolic syndrome. *Physiol Res*. 2016 Oct;65 Suppl 3:S373–80.
89. Simko F, Baka T, Krajcovicova K, Repova K, Aziriova S, Zorad S, et al. Effect of melatonin on the renin-angiotensin-aldosterone system in L-NAME-induced hypertension. *Molecules* [Internet]. 2018 Jan [cited 2020 Nov 9];23(2):265. Available from: <https://pubmed.ncbi.nlm.nih.gov/29382124/>. doi: 10.3390/molecules23020265
90. Tan DX, Manchester LC, Reiter RJ, Qi W, Kim SJ, El-Sokkary GH. Ischemia/reperfusion-induced arrhythmias in the isolated rat heart: prevention by melatonin. *J Pineal Res*. 1998 Oct;25(3):184–91.
91. Diez ER, Prados LV, Carrión A, Ponce ZA, Miatello RM. A novel electrophysiologic effect of melatonin on ischemia/reperfusion-induced arrhythmias in isolated rat hearts. *J Pineal Res*. 2009 Mar;46(2):155–60.
92. Hu ZP, Fang XL, Fang N, Wang XB, Qian HY, Cao Z, et al. Melatonin ameliorates vascular endothelial dysfunction, inflammation, and atherosclerosis by suppressing the TLR4/NF-κB system in high-fat-fed rabbits. *J Pineal Res*. 2013 Nov;55(4):388–98.
93. Favero G, Rodella LF, Reiter RJ, Rezzani R. Melatonin and its atheroprotective effects: a review. *Mol Cell Endocrinol*. 2014 Feb;382(2):926–37.
94. Torres F, González-Candia A, Montt C, Ebensperger G, Chubretovic M, Serón-Ferré M, et al. Melatonin reduces oxidative stress and improves vascular function in pulmonary hypertensive newborn sheep. *J Pineal Res*. 2015 Apr;58(3):362–73.

95. Astorga CR, González-Candia A, Candia AA, Figueroa EG, Cañas D, Ebensperger G, et al. Melatonin decreases pulmonary vascular remodeling and oxygen sensitivity in pulmonary hypertensive newborn lambs. *Front Physiol* [Internet]. 2018 Mar [cited 2021 Apr 8];9:185. Available from: <https://pubmed.ncbi.nlm.nih.gov/29559926/>. doi: 10.3389/fphys.2018.00185
96. Wiggins-Dohlvik K, Han MS, Stagg HW, Alluri H, Shaji CA, Oakley RP, et al. Melatonin inhibits thermal injury induced hyperpermeability in microvascular endothelial cells. *J Trauma Acute Care Surg*. 2014. Dec;77(6):899–905.
97. Alluri H, Wilson RL, Shaji CA, Wiggins-Dohlvik K, Patel S, Liu Y, et al. Melatonin preserves blood-brain barrier integrity and permeability via matrix metalloproteinase-9 inhibition. *PLoS One* [Internet]. 2016 May [cited 2021 Apr 15];11(5):e0154427. Available from: <https://pubmed.ncbi.nlm.nih.gov/27152411/>. doi: 10.1371/journal.pone.0154427
98. Yang Y, Sun Y, Yi W, Li Y, Fan C, Xin Z, et al. A review of melatonin as a suitable antioxidant against myocardial ischemia-reperfusion injury and clinical heart diseases. *J Pineal Res*. 2014 Nov;57(4):357–66.
99. Yu L, Gong B, Duan W, Fan C, Zhang J, Li Z, et al. Melatonin ameliorates myocardial ischemia/reperfusion injury in type 1 diabetic rats by preserving mitochondrial function: role of AMPK-PGC-1α-SIRT3 signaling. *Sci Rep* [Internet]. 2017 Jan [cited 2021 Apr 02];7(1):41337. Available from: <https://pubmed.ncbi.nlm.nih.gov/28120943/>. doi: 10.1038/srep41337
100. Yu LM, Di WC, Dong X, Li Z, Zhang Y, Xue XD, et al. Melatonin protects diabetic heart against ischemia-reperfusion injury, role of membrane receptor-dependent cGMP-PKG activation. *Biochim Biophys Acta Mol Basis Dis*. 2018 Feb;1864(2):563–78.
101. Luo GP, Jian Z, Ma RY, Cao ZZ, Zhu Y, Zhu Y, et al. Melatonin alleviates hypoxia-induced cardiac apoptosis through PI3K/Akt pathway. *Int J Clin Exp Pathol*. 2018 Dec;11(12):5840–9.
102. Fu Z, Jiao Y, Wang J, Zhang Y, Shen M, Reiter RJ, et al. Cardioprotective role of melatonin in acute myocardial infarction. *Front Physiol* [Internet]. 2020 Apr [cited 2021 Feb 03];11:366. Available from: <https://pubmed.ncbi.nlm.nih.gov/32411013/>. doi: 10.3389/fphys.2020.00366
103. Petrosillo G, Colantuono G, Moro N, Ruggiero FM, Tiravanti E, Di Venosa N, et al. Melatonin protects against heart ischemia-reperfusion injury by inhibiting mitochondrial permeability transition pore opening. *Am J Physiol Heart Circ Physiol*. 2009 Oct;297(4):H1487–93.
104. Boga JA, Caballero B, Potes Y, Perez-Martinez Z, Reiter RJ, Vega-Naredo I, et al. Therapeutic potential of melatonin related to its role as an autophagy regulator: a review. *J Pineal Res* [Internet]. 2019 Jan [cited 2020 Jan 06];66(1):e12534. Available from: <https://pubmed.ncbi.nlm.nih.gov/30329173/>. doi: 10.1111/jpi.12534
105. Küçükakin B, Wilhelmsen M, Lykkesfeldt J, Reiter RJ, Rosenberg J, Gögenur I. No effect of melatonin to modify surgical-stress response after major vascular surgery: a randomised placebo-controlled trial. *Eur J Vasc Endovasc Surg*. 2010 Oct;40(4):461–7.
106. Haghjooy Javanmard S, Ziaei A, Ziaei S, Ziaei E, Mirmohammad-Sadeghi M. The effect of preoperative melatonin on nuclear erythroid 2-related factor 2 activation in patients undergoing coronary artery bypass grafting surgery. *Oxid Med Cell Longev* [Internet]. 2013 [cited 2020 Oct 15];2013:676829. Available from: <https://pubmed.ncbi.nlm.nih.gov/23691266/>. doi: 10.1155/2013/676829
107. Gögenur I, Küçükakin B, Panduro Jensen L, Reiter RJ, Rosenberg J. Melatonin reduces cardiac morbidity and markers of myocardial ischemia after elective abdominal aortic aneurysm repair: a randomized, placebo-controlled, clinical trial. *J Pineal Res*. 2014 Aug;57(1):10–5.
108. Ghaeli P, Vejdani S, Ariamanesh A, Hajhossein Talasaz A. Effect of melatonin on cardiac injury after primary percutaneous coronary intervention: a randomized controlled trial. *Iran J Pharm Res*. 2015;14(3):851–5.
109. Dwaith KH, Al-Amran FG, Al-Sheibani BI, Al-Aubaidy HA. Melatonin effects on myocardial ischemia-reperfusion injury: impact on the outcome in patients undergoing coronary artery bypass grafting surgery. *Int J Cardiol*. 2016 Oct;221:977–86.
110. Ekeloef S, Halladin N, Fonnes S, Jensen SE, Zaremba T, Rosenberg J, et al. Effect of intracoronary and intravenous melatonin on myocardial salvage index in patients with ST-elevation myocardial infarction: a randomized placebo controlled trial. *J Cardiovasc Transl Res*. 2017 Dec;10(5-6):470–9.
111. Dominguez-Rodriguez A, Abreu-Gonzalez P, Garcia-Gonzalez MJ, Kaski JC, Reiter RJ, Jimenez-Sosa A. A uncentered, randomized, double-blind, parallel-group, placebo-controlled study of Melatonin as an Adjunct in patients with acute myocardial infarction undergoing primary Angioplasty The Melatonin Adjunct in the acute myocardial infarction treated with Angioplasty (MARIA) trial: study design and rationale. *Contemp Clin Trials*. 2007 Jul;28(4):532–9.
112. Shafiei E, Bahtoei M, Raj P, Ostovar A, Iranpour D, Akbarzadeh S, et al. Effects of N-acetyl cysteine and melatonin on early reperfusion injury in patients undergoing coronary artery bypass grafting: a randomized, open-labeled, placebo-controlled trial. *Medicine (Baltimore)* [Internet]. 2018 Jul [cited 2021 Feb 15];97(30):e11383. Available from: <https://pubmed.ncbi.nlm.nih.gov/30045259/>. doi: 10.1097/MD.00000000000011383
113. Barati S, Jahangirifard A, Ahmadi ZH, Tavakoli-Ardakani M, Dastan F. The effects of melatonin on the oxidative stress and duration of atrial fibrillation after coronary artery bypass graft surgery: a randomized controlled trial. *Endocr Metab Immune Disord Drug Targets* [Internet]. 2020 Jul [cited 2020 Dec 15];21(6):2021. Available from: <https://pubmed.ncbi.nlm.nih.gov/32723264/>. doi:10.2174/1871530320666200728152307
114. Jouybar R, Setoodeh M, Saravi ZF, Ahmadi S, Karami A, Khademi S, et al. The effect of melatonin on the serum level of interleukin 6 and interleukin 9 in coronary artery bypass grafting surgery. *Asian J Anesthesiol*. 2020 Mar;58(1):35–44.
115. Sánchez-Barceló EJ, Mediavilla MD, Tan DX, Reiter RJ. Clinical uses of melatonin: evaluation of human trials. *Curr Med Chem*. 2010;17(19):2070–95.
116. Navarro-Alarcón M, Ruiz-Ojeda FJ, Blanca-Herrera RM, A-Serrano MM, Acuña-Castroviejo D, Fernández-Vázquez G, et al. Melatonin and metabolic regulation: a review. *Food Funct*. 2014 Nov;5(11):2806–32.
117. González González A, Rueda Revilla N, Sánchez-Barceló EJ. Clinical uses of melatonin: evaluation of human trials on cancer treatment. *Melatonin Res*. 2019 Jun;2(2):47–69.

118. Trotti LM, Karroum EG. Melatonin for sleep disorders in patients with neurodegenerative diseases. *Curr Neurol Neurosci Rep* [Internet]. 2016 Jul [cited 2020 Dec 15];16(7):63. Available from: <https://pubmed.ncbi.nlm.nih.gov/27180068/>.doi: 10.1007/s11910-016-0664-3
119. Reiter RJ, Tan DX, Manchester LC, Paredes SD, Mayo JC, Sainz RM. Melatonin and reproduction revisited. *Biol Reprod*. 2009 Sep;81(3):445–56.
120. Maria S, Witt-Enderby PA. Melatonin effects on bone: potential use for the prevention and treatment for osteopenia, osteoporosis, and periodontal disease and for use in bone-grafting procedures. *J Pineal Res*. 2014 Mar;56(2):115–25.
121. Lundmark PO, Pandi-Perumal SR, Srinivasan V, Cardinali DP. Role of melatonin in the eye and ocular dysfunctions. *Vis Neurosci*. 2006 Nov-Dec;23(6):853–62.
122. Skobowiat C, Brożyna AA, Janjetovic Z, Jeayeng S, Oak ASW, Kim T-K, et al. Melatonin and its derivatives counteract the ultraviolet B radiation-induced damage in human and porcine skin ex vivo. *J Pineal Res* [Internet]. 2018 Sep [cited 2020 Nov 16];65(2):e12501. Available from: <https://pubmed.ncbi.nlm.nih.gov/29702749/>. doi: 10.1111/jpi.12501
123. Weishaupt JH, Bartels C, Pölking E, Dietrich J, Rohde G, Poeggeler B, et al. Reduced oxidative damage in ALS by high-dose enteral melatonin treatment. *J Pineal Res*. 2006 Nov;41(4):313–23.
124. Seabra ML, Bignotto M, Pinto LR Jr, Tufik S. Randomized, double-blind clinical trial, controlled with placebo, of the toxicology of chronic melatonin treatment. *J Pineal Res*. 2000 Nov;29(4):193–200.
125. Gitto E, Romeo C, Reiter RJ, Impellizzeri P, Pesce S, Basile M, et al. Melatonin reduces oxidative stress in surgical neonates. *J Pediatr Surg*. 2004 Feb;39(2):184–9.
126. Gitto E, Pellegrino S, Gitto P, Barberi I, Reiter RJ. Oxidative stress of the newborn in the pre- and postnatal period and the clinical utility of melatonin. *J Pineal Res*. 2009 Mar;46(2):128–39
127. Andersen LP, Gögenur I, Rosenberg J, Reiter RJ. The safety of melatonin in humans. *Clin Drug Investig*. 2016 Mar;36(3):169–75.
128. Galley HF, Lowes DA, Allen L, Cameron G, Aucott LS, Webster NR. Melatonin as a potential therapy for sepsis: a phase I dose escalation study and an ex vivo whole blood model under conditions of sepsis. *J Pineal Res*. 2014 May;56(4):427–38.
129. Küçükakin B, Lykkesfeldt J, Nielsen HJ, Reiter RJ, Rosenberg J, Gögenur I. Utility of melatonin to treat surgical stress after major vascular surgery – a safety study. *J Pineal Res*. 2008 May;44(4):426–31.
130. Therapeutic Goods Administration. Australian public assessment report for melatonin [Internet]. Australia: TGA; 2009 Dec [cited 2020 Nov 12]. 57p. Available from: <https://www.tga.gov.au/sites/default/files/auspar-circadin.pdf>.
131. Foley HM, Steel AE. Adverse events associated with oral administration of melatonin: a critical systematic review of clinical evidence. *Complement Ther Med*. 2019 Feb;42:65–81.
132. Harpsøe NG, Andersen LP, Gögenur I, Rosenberg J. Clinical pharmacokinetics of melatonin: a systematic review. *Eur J Clin Pharmacol*. 2015 Aug;71(8):901–9.
133. Andersen LP, Gögenur I, Rosenberg J, Reiter RJ. Pharmacokinetics of melatonin: the missing link in clinical efficacy? *Clin Pharmacokinet*. 2016 Sep;55(9):1027–30.
134. Andersen LP, Werner MU, Rosenkilde MM, Harpsøe NG, Fuglsang H, Rosenberg J, et al. Pharmacokinetics of oral and intravenous melatonin in healthy volunteers. *BMC Pharmacol Toxicol*. 2016 Feb;17(1):8–12.



# Trauma and emergencies

**Whakaari/White Island eruption – an overview  
of volcanic trauma and its management**

John Burnett, Matthew Taylor

---

**A beginner's guide to in-flight  
medical emergencies**

Gareth Jones, Nicola Emslie, Dean Bunbury

---

# Whakaari/White Island eruption – an overview of volcanic trauma and its management

## John Burnett, MBChB, FANZCA

Department of Anaesthesia and Pain Medicine, Middlemore Hospital, Auckland, NZ

Monday 9 December 2019 was the first day of Dr John Burnett's burns anaesthesia fellowship at Middlemore Hospital. He works as a specialist anaesthetist at this hospital, with interests in both burns and paediatric anaesthesia.

## Matthew Taylor, MBChB, FANZCA

Department of Anaesthesia and Pain Medicine, Middlemore Hospital, Auckland, NZ

Dr Matthew Taylor is a specialist anaesthetist at Middlemore Hospital with interests in burn management and regional anaesthesia. As a secondary effect of living in the North Island of New Zealand, Matt has a side interest in volcanic risks.

## DISCLAIMER

At the time of writing this article there is an active coronial inquest into the events on Whakaari following the eruption on 9 December 2019. For this reason, some details are not available or fully elucidated.

## INTRODUCTION

On 9 December 2019 at 2.11 pm, New Zealand experienced an unheralded eruption from the Whakaari/White Island volcano off the coast of the Eastern Bay of Plenty. This phreatic eruption, while small from a geological reference, was significant due to the presence of tourist groups within 1000 metres of the vent and exposed in close proximity to the force of the resultant pyroclastic surge.

Forty-seven people were on the island at the time of the eruption. Thirty-nine of these were emergently evacuated by sea and air to local healthcare facilities, with 31 burn injured patients being stabilised, transferred to regional burn centres and then on to New Zealand and Australian specialist centres. Despite historical mortality of such events commonly exceeding 90 per cent, an overall mortality of 47 per cent was seen from this event.

Volcanic eruptions causing human casualty are rare, therefore accounts on the management of volcanic burn trauma are limited. The purpose of this article is to provide an educational overview of volcanic trauma, the complex injuries that result and to share insight and learnings from the events on Whakaari.

## BRIEF HISTORY OF MODERN-DAY VOLCANIC ERUPTIONS

Volcanic eruptions represent a source of catastrophic trauma due to the energy release involved. In the 20th century it is estimated that more than 90,000 people have been killed by the effects of volcanic phenomena<sup>1</sup>, most commonly as a result of Pyroclastic Density Currents (PDCs), lahars and tephra (ash and rock fall). Historically, volcanic mortality most commonly occurred secondary to mass disaster events from tsunami and climate change related famine.

There are few descriptions of events for individuals caught in close proximity to an eruption. As major eruptions typically have precursor changes in the volcano, the occasions where people have been in close proximity have tended to involve phreatic type eruptions, which involve the explosive decompression of superheated and pressurised vent systems. Although new magma is not ejected from the volcano, these processes nevertheless represent a very significant energy release. Many of the volcanoes present in the Taupō volcanic zone of the North Island of New Zealand such as Ruapehu, Tongariro, Ngauruhoe and Whakaari can display this style of vulcanism.

In recent decades, the few medical and geological descriptions of eruptions that involve people describe a very high mortality rate. The Mount Saint Helens eruption of 1980 was a large event where pyroclastic density currents and lahars killed all 57 people caught in the flows and at some distance from the mountain<sup>2</sup>. Of the five burn trauma patients admitted to hospitals, all died. Some people on the margins of the flows survived. In 1991 in Japan, the Unzen volcano erupted and 41 observers were caught in a PDC that detached from the main flow and enveloped their location. There was a 98 per cent mortality in this group, with 13 admitted to hospitals with severe burns and inhalational injuries and only one survivor<sup>3</sup>. In 2014, also in Japan, the Ontake Volcano erupted unexpectedly when a large number of hikers were on the flanks. This phreatic eruption produced little ash or PDCs, with the majority of injuries related to ballistic trauma. There were 63 deaths, roughly estimated to represent a 50 per cent mortality, although the numbers reported vary<sup>4</sup>. In 1993 a phreatic eruption on the

Galeras volcano in Columbia occurred while 16 people (mostly volcanologists) were in or on the edge of the caldera<sup>5</sup>. They were subject to ballistic trauma and contact burns from hot rocks. There was no PDC associated with this event, yet still a 56 per cent mortality was seen. Other events in Soufrière Hills, Monserrat (1997) and Merapi, Indonesia (1994, 2010) involved people caught in PDCs with mortality ranging from 60-95 per cent<sup>6</sup>.

## TE PUIA O WHAKAARI

Whakaari/White Island is a submerged stratovolcano 48 kilometres off the eastern coast of New Zealand's North Island in the Bay of Plenty region. It represents the northern aspect of the Taupō volcanic zone and is New Zealand's most active volcano with more than 30 phreatic, phreatomagmatic and magmatic eruptions having occurred since 1826. It thus earns the full Māori name Te Puia o Whakaari – The Dramatic Volcano. Between eruptive events, Whakaari displays outgassing and fumarolic activity, typically occupying a volcanic alert level of 1-2 (minor unrest and moderate to heightened volcanic unrest respectively)<sup>8</sup>. Although the volcano rises 600-700 metres from the sea floor and spans 16 by 18 kilometres at its base, only 321 metres protrudes above sea level. The main crater structure is 30 metres above sea level and easily reached by boat from the mainland. Due to its activity and ease of access, Whakaari is a focus of geological research and since it was declared a private scenic reserve in 1953, attracts more than 10,000 tourists annually.

## THE EVENT ON 9 DECEMBER 2019

The 2019 phreatic eruption was caused by an explosive decompression of heated, pressurised rock saturated with acidic volcanic fluids. The Whakaari hydrothermal system consists of hot fluids released as vapour from magma, mixed with groundwater and seawater ingress from above. Through this, magmatic fluids and gases (H<sub>2</sub>O, CO<sub>2</sub>, SO<sub>2</sub> (Sulfur dioxide), H<sub>2</sub>S (Hydrogen Sulfide), NH<sub>3</sub> (Ammonia)) are expressed from magmatic outgassing and captured in solution<sup>9</sup>. This results in very high concentrations of acids: predominantly Sulfuric (H<sub>2</sub>SO<sub>4</sub>) and Hydrochloric (HCl), but also Hydrofluoric (HF), Hydrobromic (HBr) and Hydroiodic (HI) acids in differing orders of magnitude. The pH of these fluids and the crater lake range from +1.5 to -1 depending on the flux of outgassing from the magma below<sup>10</sup>.

These fluids saturate the porous rock overlying the magma and are heated to several hundred degrees celsius. When new magma intrudes into the subterranean structure it acts to "prime" the system as it is pressurised from magmatic heating below and the weight of rock from above, then sealed by the deposition of silica and hydrothermal minerals. In the Whakaari system, this is additionally capped by a layer of molten sulphur that increases in viscosity with heating, further tightening the seal and raising the pressure. In this state, it is estimated the rock-brine system is heated and pressurised to 200-300°C/6.5 MPa at a relatively shallow depth<sup>11</sup>.

The eruptive event occurred when a small change allowed disruption of the upper seal, resulting in liquid water explosively phase transitioning into water vapor. The liquid can increase to 1700 times its original volume and this expansion is supersonic in speed, producing a high-pressure decompressive wavefront, followed by superheated steam. Rock saturated in the water fragments to ash and is ejected from the vent as high speed ballistics and tephra, which then falls back as a PDC. Eruptions such as this are considerably more violent than those driven simply by gas expansion<sup>11</sup>. During fluid vapourisation, the acidic solution dries on the surface of ash particles, forming a concentrated coating. Elemental sulphur, sulphate and sulphide minerals are common (3-5 wt%) within such hydrothermal ash, which readily oxidise to form a rich supply of H<sub>2</sub>SO<sub>4</sub><sup>12</sup>. Experimental studies suggest that ash and lapilli (smaller ballistics) are ejected at 208-221 m/s in the presence of steam flashing. This process repeats several times from the top downwards creating multiple eruptive "lobes" that feed the eruptive column and subsequent PDC. It has been estimated that 11 such lobes comprised the 2019 eruption<sup>13</sup>.

## MECHANISMS OF VOLCANIC TRAUMA

There are a number of potentially lethal hazards produced from volcanic eruptions. The mortality for those caught in close proximity (<5km) is very high, most commonly from PDC phenomena<sup>4</sup> but also from high velocity ballistic trauma, ash fall asphyxiation and gas inhalation. As the distance from the eruptive event climbs over 25 kilometres, tsunami and lahars become a more common mechanism of trauma.

PDCs are fast moving clouds of superheated volcanic gases and tephra (rock particles sized from ash to larger rock clasts) that spread rapidly outwards from the eruptive site either as dense ash-avalanches flowing down mountain sides under gravity or, as in the 2019 episode, a more dilute base surge projecting out from the vent. They can flow at speeds greater than 350 km/hr and achieve temperatures exceeding 400°C. PDCs were the primary cause of mortality at Pompeii and Herculaneum and have accounted for 70 per cent of direct volcanic

mortality in the past 400 years<sup>14</sup>. More detailed modern assessments of PDC events show a mortality rate of >90% due to thermal injury from the intense heat involved, ash asphyxiation due to inhaled particulate matter and direct toxicity from gas inhalation. Infrequently lightning strikes can cause death from static electricity generated in the ash cloud.

### Thermal energy of PDCs

The temperature of the 2019 Whakaari pyroclastic surge was at the lower end of described PDCs. The eruptive process occurred at ≥250°C and, as the PDC flowed outwards, it was cooled by entrained air. The three tourist groups present at the time would have experienced differing thermal loads based on their distance from the vent and their position within the surge as the density and therefore temperatures are not homogeneous. The exact temperature as it impacted individuals is difficult to determine. There was minimal melting of synthetic clothing, which begins to occur above 170-200°C<sup>15</sup>. However, survivors described hearing their hair singe, which is associated with temperatures of over 120°C<sup>16</sup>. Considering the average wood fire burns at approximately 600°C the temperature of this surge appears comparatively low, however a PDC is much more efficient at thermal transfer than most causes of burns encountered in clinical practice. Heat is thought to be transferred to the human body from a PDC predominantly via radiation and convection. Transfer via conduction is also possible through thin clothing and, more commonly, via ash when it is deposited on exposed skin or contact with hot ballistics. The degree of thermal injury is dependent on the total heat flux, duration of exposure and thickness and type of protective layering.

A basic equation for calculating total heat flux is shown below, with the first half describing the radiative component and the second reflecting the convective component<sup>6</sup>.

$$q = \varepsilon\sigma(T_i^4 - T_m^4) + h_c(T_i - T_m)/1000$$

q = Heat flux (kW/m<sup>2</sup>)

T<sub>i</sub> = Heat source temperature (°K)

T<sub>m</sub> = Material surface temperature (°K)

ε = Emissivity (0.05 for a gas to 1 for a black body)

σ = Stefan Boltzmann constant (5.6710<sup>-8</sup> Wm<sup>-2</sup>K<sup>-4</sup>)

h<sub>c</sub> = Convective heat transfer factor

Severe thermal injury can occur despite relatively "low" temperatures for a number of reasons. First, the radiative emissivity of a PDC is close to that of a black body and when engulfed, one is subject to a large surface area or "view factor" of exposure, which increases heat flux. Secondly, the convective heat transfer factor increases significantly due to the high velocity of the surge. Thirdly, ash has a very high heat capacity and a high water content, resulting in dramatic latent heat release when steam condenses on human tissue. Finally, a layer of adherent ash on skin provides conductive heat transfer causing ongoing thermal injury.

### Volcanic gases

An individual enveloped in a PDC is also subject to high concentrations of volcanic gases derived from the underlying magma. These are predominantly H<sub>2</sub>O, CO<sub>2</sub>, SO<sub>2</sub>, and H<sub>2</sub>S. Inhalation of these can be fatal, either through the anoxic environment created or; in the case of H<sub>2</sub>S, which is a physiological chemical messenger, direct inhibition of respiratory centres and interruption of cellular respiration. Levels of >30% CO<sub>2</sub> or 900ppm of H<sub>2</sub>S are considered to be rapidly fatal and as these gases are heavier than air, they can concentrate in low lying spaces<sup>4,17</sup>. It is noteworthy that some individuals who died on the island were found in low lying stream beds, which may indicate such gas asphyxiation.

### Acidic injury

This episode revealed an acidic component to burn injuries not previously described in volcanic burn trauma. As noted above, the eruption generates a transient pressure wave followed by a steam flow and then a mixed gas and ash PDC. The steam, gas and ash all carry acids in aqueous and gaseous form from the hydrothermal system and in the case of Whakaari, an additional component of molten elemental sulphur. These can be inhaled and deposited on to cutaneous tissues resulting in tissue trauma and metabolic derangements, discussed in further detail below.

## TOUR GROUP LOCATIONS AT THE TIME OF EVENT: IMPACT ON INJURIES

**Figure 1. Map of tour walking route and group locations relative to eruptive vent (adapted from Google satellite image). Diagram of Whakaari (inset)**

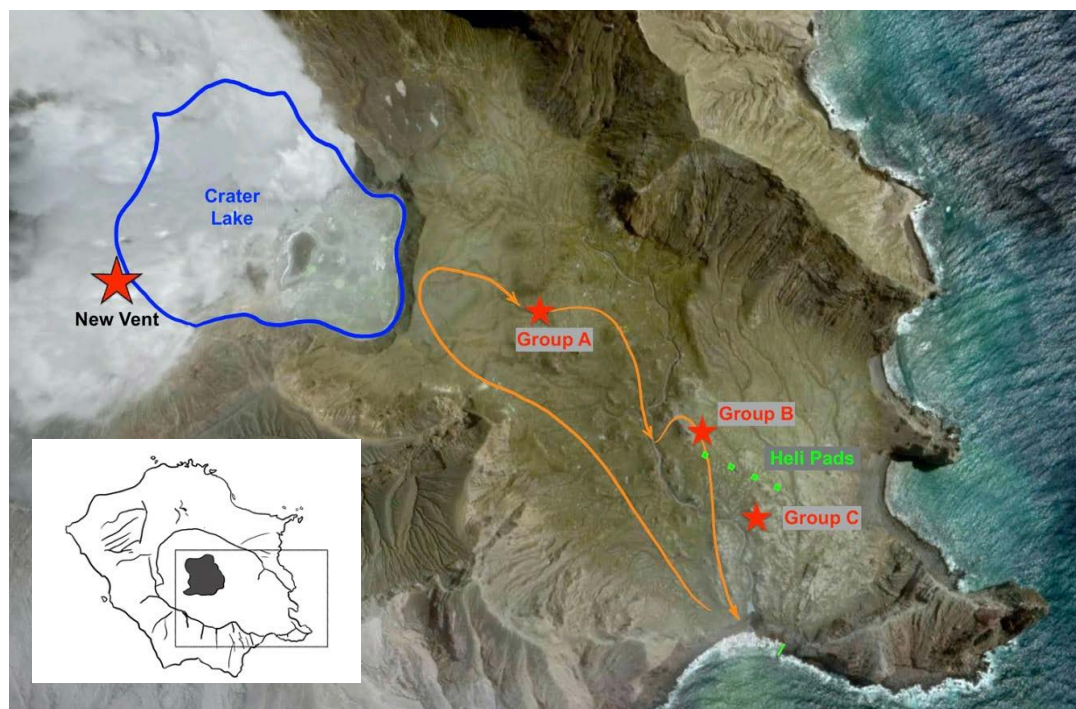

There were 47 individuals on the island at the time of the eruption. Two tour groups, each comprising 19 tourists with two guides (Groups A and B), as well as a heli-tour group of four tourists and one guide (Group C). All had been supplied with activated charcoal respirators to minimise airway irritation from fumarole gases. Most individuals were dressed lightly given the seasonal conditions. We hypothesise that the position of each group at the time of the eruption may have affected their outcomes.

Locations were able to be estimated from patient histories and geolocation metadata from phone camera images. The ability to gain cover from full exposure to the surge appeared to impact the severity of injury. As the PDC cloud travelled at approximately  $10\text{--}15\text{ms}^{-1}$ , the groups had varying amounts of time to gain cover depending on how far away from the vent they were and how visible the initial eruption was.

Group A was the closest to the vent at the time of the eruption, approximately 500 metres away in an exposed location between two low hills that acted to channel the surge as well as hide it from view until it was virtually upon them.

The severity of burn trauma in this group was much higher. Of the 21 people, eight died on the island and five died during transfer prior to being formally admitted to the hospital system. A further five died in hospital; three within 48 hours and two on days five and 32. Three patients survived from Group A for a group mortality rate of 86 per cent which, although high, is still considered to be the lower end of mortality described when caught in a PDC. Median initial burn Total Body Surface Area (TBSA) involvement of the group admitted to hospital was 67 per cent, although this will have increased considerably in the days following as the chemical component caused burn evolution.

Group B, also totalling 21 people, was approximately 700 metres from the vent and participants were instructed by their guides to take shelter behind a large rock mound 50 metres away. This rock outcrop protected them from the full force of the initial pressure and surge wave and likely diverted some of the pyroclastic flow around it. They also had variable exposure to heat flux depending on their particular placement within this group, with those near the centre experiencing less. All were successfully extricated by boat to the mainland. A wide distribution of burns was seen, with a median TBSA of 36 per cent (ranging from 9–80 per cent), depending on where exactly the people were located in the huddle behind the rock. Some who were unable to utilise the

respirators provided also developed significant inhalation injuries<sup>18</sup>. Three patients from Group B died on days six, 13 and 50 post-event for a total group mortality of 14 per cent. This is an order of magnitude lower than that described from previous PDC events and warrants further investigation as to the potential reasons. We postulate that this group was not exposed to the full force of the PDC, most likely due to their actions of taking shelter and the use of personal protective equipment such as respirators.

At approximately 1000 metres from the vent, close to the waterline, Group C was the furthest away when the PDC reached them, approximately 90 seconds after the eruption. Fortunately three of five of these people were able to submerge themselves where the surge, in common with other low density PDCs, continued to flow over the surface of the water. They managed to remain submerged for the duration of the PDC passing overhead, estimated to be 30 seconds. The two who were unable to reach the shoreline in the time available were caught by the PDC without cover and received burns of 48 per cent and 58 per cent TBSA. One of these patients died several months post-injury following repatriation.

## RESCUE AND PRE-HOSPITAL MANAGEMENT

Following the eruption, Group B was able to extract themselves back to the wharf through hot ash deposits. This was also the area Group C had moved to in an effort to get underwater. Group A by comparison had more people severely injured and incapacitated. It appears that one of the guides attempted to ensure respirators were in place on their group and then go for help with two others, however only one managed to make it to the wharf.

At the time of the eruption there were two Whakaari tour boats located just offshore. Group B and C were evacuated quickly onto one of these boats, which contained participants from a previous tour. The heli-tour group (Group C) was evacuated in this manner as their helicopter was destroyed by the PDC. En route to Whakatane, first aid was provided by the previous tour group, including some off-duty health professionals, a medical student, and later paramedics that intercepted the boat via the local coastguard. A chain of water was created from onboard tanks to the patients in an effort to cool and also decontaminate burn wounds. The boat trip normally takes on average 80 minutes to cover the 48 kilometre journey.

Of the 21 people in Group A, one who self-extricated to the wharf was evacuated by the second tour boat and 12 were evacuated by air within two hours of the eruption by the combined effort of three tour company helicopters. These casualties would have been lying in hot ash for a much longer time than groups B or C. The remaining eight people were either un-responsive when found by helicopter pilots or died before transport could occur. A co-ordinated recovery effort days after the eruption was able to retrieve the bodies of six of these victims.

The core tenants in burn first aid<sup>19</sup> of arresting the burn process and providing cooling to the burn wound were challenging to achieve in many patients due to the geographical isolation and limited resources available. Despite these difficulties, we hypothesise that decontamination with water by first responders on the boats likely attenuated the depth and severity of both thermal and chemical injuries.

## INITIAL MASS CASUALTY MANAGEMENT

A mass casualty incident locally and nationally was recognised within minutes of the eruption. Whakatane Hospital, the closest to Whakaari, is a small 96-bed regional centre with a modestly staffed 18-bed emergency department (inclusive of three resuscitation bays). The closest tertiary centre with a regional burn unit is Waikato Hospital, 188 kilometres away. Due to the large number of uninjured people from previous tour groups arriving by boat, operational stages were established at Whakatane Hospital, the local airfield and the wharf; the latter triaging almost 100 people. Seven patients at Whakatane wharf and one at the airfield required immediate airway management and were transferred directly to tertiary centres. The first evacuees arrived at Whakatane Hospital approximately two hours after the eruption. The Whakatane team, with the help of the local medical community and assistance from the national ambulance service, effectively triaged and stabilised 30 severely burn-injured patients prior to transfer. This was complicated and challenging not just because of the sudden demand on resources from multiple unwell patients but also the evolving physiological derangement seen far in excess of that typically found even with major burns. Many intubated patients required hand ventilation for a period of time as there were not enough ventilators. Institution of resuscitation measures and monitoring was difficult, as in many cases, the pelvic region and feet were the only non-burned areas.

There are three regional burn centres in New Zealand as well as one national centre located at Middlemore Hospital in Auckland. At the time of the eruption, the national burns unit was at 140 per cent capacity and had a full intensive care unit. To allow decanting of non-burn patients from the ICU, many patients from Whakatane were distributed evenly across regional burn centres in the country for initial management (as shown in Figure 2). At these regional centres, early primary debridements were conducted with temporary skin cover. Within the first



week post eruption, 13 patients were repatriated to Australian burns centres in New South Wales and Victoria, markedly reducing the load on the burns network in New Zealand.

Overall, of the 47 on the island at the time of the eruption, 39 survivors were found alive and evacuated. Five died en route or prior to formal hospital admission. Thirty-one were admitted to the national burns network, while three (from Group C) were treated for minor burns and discharged. Of the 31 admitted to tertiary burns centres nine patients (29%) subsequently died. This is depicted below in Figure 2.

**Figure 2. Diagram of patient distribution post-event (\* includes airstrip, hospital and wharf, and \*\* denotes regional burn centres)**

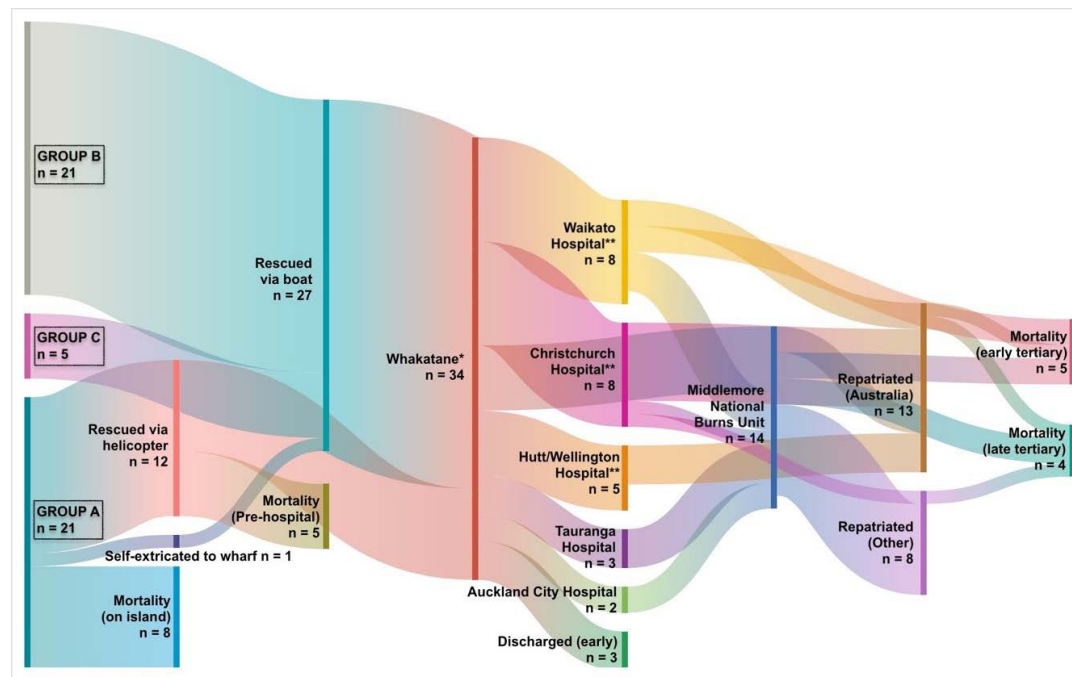

## TERTIARY MANAGEMENT

Upon arrival to specialist burn centres it quickly became clear that there was burn wound evolution and physiological impairment out of proportion to the surface area burned. The thermal component of the burn was enhanced significantly by the presence of strong acids within the ash; predominantly  $H_2SO_4$ , HCl, and HF. This resulted in rapid burn extension, severe metabolic derangement and later, inhalational involvement.

Volcanic ash is at essence microscopic glass shards and in this state also coated with acidic residue. First responders to the island immediately after the eruption described very challenging conditions, with ash irritating mucous membranes and exposed skin despite protective clothing. Even in tertiary centres, ash coating patients continued to be an irritant to the airways and contacted skin of medical personnel. As a consequence, N95 particulate-filtering respirators were worn by staff during initial care and debridement procedures. Staff in resus managing ash coated patients also found it necessary to change gloves on a regular basis as the nitrile was rapidly degraded by the abrasive and acidic ash.

### Physiological changes

Extreme metabolic derangement was seen, again unexpectedly severe in the context of initial TBSA assessments. Multiple patients were very acidaemic presenting with pH levels ranging from 6.9-7.1 and base excess levels below -15 mmol/L despite, in many cases, relatively preserved lactates and little haemoconcentration, indicating adequate fluid resuscitation. Acute renal failure requiring renal replacement therapy was common; high troponin levels (even in young patients) as well as hypocalcaemia in excess of that typically seen in burn injuries. Hypocalcaemia in particular became an issue in the initial 48 hours and required aggressive replacement.

This unusual metabolic milieu was presumed to be secondary to the effects of the strong acids coating the ash particles, which when brought into contact with patients' skin resulted in systemic absorption and a degree of toxicity, from HF,  $H_2SO_4$  and HCl in particular. Early ionic analysis of ash samples taken from four patients confirmed this with significant presence of sulphate, chloride, fluoride and bromide anions<sup>20</sup>.

Hydrofluoric acid (HF) is the inorganic acid of elemental fluorine and although HF burns are an unusual occurrence in clinical practice, they have been described in the industrial setting. Similar to other strong acids, corrosive tissue destruction can occur due to hydrogen ions, however, because of the low dissociation constant of HF the severity of injury through this mechanism is limited. The major mechanism of damage is through the effect of fluoride ions. HF is very lipophilic in nature allowing free fluoride ions to penetrate deeply into tissues and cause liquefactive necrosis<sup>21</sup>. This differentiates it from other strong acids, which tend to cause tissue destruction via coagulation necrosis. Evidence of such deep tissue liquefaction was found in at least one patient during primary debridement. The metabolic consequences of fluoride toxicity from HF are significant, with deaths reported from as little as 2 per cent TBSA burns with concentrated solution<sup>22</sup>. Fluoride ion liberation into deep tissues causes direct cellular toxicity and forms insoluble chelate salts with the major bivalent cations calcium and magnesium causing severe depletion if body stores cannot be mobilised fast enough. If the exposure is high, clinical manifestations are those of profound systemic hypocalcaemia and hypomagnesaemia and can include shock and cardiac arrhythmia.

Depletion of cellular calcium causes inhibition of the sodium-potassium ATPase pump resulting in increased cellular permeability<sup>23</sup>. Resultant localised hyperkalaemia along with other electrolyte shifts at nerve endings is thought to be the mechanism by which intense pain is experienced by those with HF burns<sup>24</sup>. For refractory hypocalcaemia and hypomagnesaemia, haemodialysis and early burn wound excision is suggested to be beneficial<sup>21</sup>.

Sulfuric acid ( $H_2SO_4$ ) is also thought to have contributed both to the systemic hypocalcaemia and extreme metabolic acidosis seen in multiple cases. With a pH ranging from 0.3-2.1,  $H_2SO_4$  has a high dissociation constant and undergoes a vigorous exothermic reaction when it contacts water in human tissue<sup>24</sup>. This results in rapid cellular dehydration and deep burns.

In patients with the most profound acid-base disorders, most were persistently vasoplegic despite high dose vasopressor and inotrope therapy. It was found that, early in the primary debridement phase, both metabolic and physiological instability steadily improved as the burn tissue was excised from these patients. This is contrary to the course normally seen with an aggressive primary debridement, where the surgery tends to contribute transiently to the global inflammatory state. Correspondingly, primary debridement was expedited for these cases, adding to the surge in workload for regional burn centres in the first two weeks.

### Inhalation injury and the effect of respirators

Inhalation injury is well known to increase the risk of mortality in burn trauma. Given the nature of this eruption and the extent of the burns sustained by those exposed to the PDC it would have been expected that thermal and chemical inhalation injury was a prominent finding. Surprisingly the severity of thermal inhalation injury appeared to be minimal, especially in the context of the cutaneous injuries seen. Very little volcanic ash or blistering of lower airways was seen on bronchoscopy of patients on day zero. Inhalational toxicity typically has a delayed presentation (>24 hours), which was seen at Middlemore Hospital in two of 14 patients who developed severe Acute Respiratory Distress Syndrome (ARDS) during the first week. The pathology in those with significant inhalation injury was thought to be caused mainly by aforementioned toxins in the PDC including elemental sulphur,  $SO_2$  and  $H_2S$ . It is likely that the hydrogen halide acids such as HCl and HF were also inhaled in appreciable amounts and these are known potent airway irritants<sup>25</sup>.

All people on the island had been issued with half face respirators<sup>26</sup> utilising activated charcoal filters<sup>27</sup> in order to mitigate irritation from fumarole gases. Indeed, individual accounts from survivors described it being very difficult to breathe during and after the surge without the respirators. It is not expected that these respirators would provide complete protection in the event of exposure to a PDC, however we believe that the ability to use them may have reduced the risk and severity of inhalation injury in survivors. From multiple accounts, the force of the surge displaced their respirators, which then had to be donned again where possible. It seems that many in Group A who were incapacitated were unable to replace these. At least one Group B patient who was unable to re-don their respirator, later went on to develop ARDS requiring a prolonged ICU course, out of keeping with their TBSA injury.

Unlike previous pyroclastic events such as Mount Saint Helens, USA and Unzen, Japan, where subjects captured in the flow were asphyxiated by ash clogging their tracheal and bronchial airways, there was little to no evidence of ash deposits in the airways past the larynx in patients from this event. This may have been due to respirator use and also clumping of fine ash particles in the steam rich surge, thus reducing the likelihood of inhalation.

## Ballistics

Ballistics are large ejected clasts and account for approximately 40 per cent of injuries (many carrying a high mortality) within a five-kilometre distance from eruptive vents<sup>4</sup>. Overall, there were relatively few ballistic injuries seen, particularly in Groups B and C, which may again reflect both distance from the vent and ability to gain shelter. In Group A patients managed at Middlemore Hospital, one presented with a scapula fracture and another with deep contusions presumed to be from ballistic injury. Information regarding ballistic injury in wider Group A fatalities and survivors is currently unavailable pending forensic findings.

## Prevention and management of infection

The tank water on board the tour boat that was used to cool and decontaminate patients was, although effective in mitigating the severity of burns in many cases, thought to be colonised with some unusual microorganisms. *Chryseobacterium Indologenes* and *Elizabethkingia miricola* were identified in the burn sites in at least three patients in Group B. Having originally been isolated in a condensation tank on the space station Mir<sup>29</sup>, *E. Miricola* is often found in fresh water tanks and both organisms have intrinsic resistance to a wide array of antibiotics<sup>29</sup>. Cases were managed in keeping with multi-resistant organism infection control precautions, necessitating occlusive personal protective equipment (PPE) cover for theatre team members whilst maintaining intraoperative working temperatures of 25–30°C to preserve patient normothermia. Operating theatres managing patients with evidence of these resistant bacteria consequently underwent hydrogen peroxide vapor decontamination in between cases. Daily consultation with infectious disease specialists was sought to gain up to date advice regarding both surgical prophylaxis and infection treatment options, which the authors believe was an important part in the prevention and mitigation of severe infection in this group of patients.

## Tertiary level organisation and resource demand

On the surface it would be reasonable to assume that 31 patients distributed among four specialist burn centres, with almost half being repatriated to Australia in the first week, would allow a manageable workload. However, the severity, complexity and relentless evolution of burn injuries made it more challenging than anticipated for these centres during the first month. To use the National Burns Unit at Middlemore Hospital as an example, intensive care patients were decanted to other Auckland units and major elective surgeries were deferred with even some acute procedures being diverted to local area hospitals. Normally this unit runs a burn list three times per week. Over the first two weeks at Middlemore, across three theatres, there were a total of 187 hours of operating. This did not include anaesthetic time, which was extensive initially in order to stabilise, transfer and establish invasive monitoring, clean lines and jejunal feeding tubes. One theatre was running constantly for the first 60 hours, due to the emerging necessity for early and aggressive debridement to mitigate burn evolution and physiological derangement. The human resource required to achieve and maintain this was enormous. If operating theatre minutes is used as a metric, this event was equivalent to six months of work over the space of three months, with the majority occurring in the first month.

## CONCLUSION

While it is very unfortunate that there was human presence on Whakaari at the time of this eruption, the overall mortality (47 per cent) and in particular the in-hospital mortality (29 per cent) was much lower than previously reported events. There are a number of potential factors contributing to this. The proximity of groups to the eruptive vent and more importantly the ability to gain shelter determined the heat flux experienced, with many individuals in Groups B and C suffering less severe trauma than those in Group A. The Whakaari tour guides were well trained and decisively instructed individuals to take cover and wear the provided respirators. We hypothesise that the use of respirators reduced the incidence and severity of inhalation injury.

Many patients rescued by boat received early cooling and decontamination, which anecdotally resulted in attenuation of the thermal and potentially chemical component of their burn injury. Early and effective application of severe burn management principles at Whakatane followed by expeditious transfer to burn centres was a strong positive contributor to the low mortality rates seen. At a tertiary level, early recognition and management of the metabolic sequelae unique to these burn injuries is thought to have had a positive effect on outcome and this has previously not been appreciated in the management of volcanic burn trauma.

From a geological perspective, this was a small eruption but unique with regard to the presence of people close to the vent. Even more unusual, individuals caught in a hot, fast moving pyroclastic surge were able to modify their exposure in a way that improved survivability in a manner not previously described. It is important to put this event into historical context. High temperature PDC events such as that at Herculaneum are unsurvivable, so there is little chance for reflection on the medical management of extreme cases. Nevertheless, there have been a number of recorded episodes where people on the periphery of a PDC have survived and learnings from Whakaari could improve this.

We sincerely hope that an event such as this never happens again, however it is likely that human contact with volcanic hazards will occur in the future. Worldwide, many human habitations are located on the fertile soils of volcanoes; volcanic trauma therefore continues to be an international risk. In New Zealand, particularly Auckland and the Taupō volcanic zone, there are many sites that are heavily populated or remain popular tourist and recreational destinations. Many of these volcanoes have similar potential for unheralded eruptions with fluoride-rich geochemistry. As has been seen in the Tarawera/Okataina eruption in recorded history, as well as Taupō and Reporoa prehistoric events, eruptive events of international significance have and will again occur in New Zealand.

## ACKNOWLEDGEMENTS

The better than expected survival rate from this event could not have been possible without the bravery and combined effort of everyone involved ranging from civilian first responders to pre-hospital and specialist centre staff. It is difficult to describe in the words of this article the remarkable effort by Whakatane Hospital and its community through a truly impressive mobilisation of stretched local resource. Having a reputation for such already, they showed incredible resilience as a team in the face of a very overwhelming situation. At the same time, it is important to acknowledge the psychological trauma that many people involved have and continue to experience.

Similar credit should be given to the actions of non-medical individuals on 9 December 2019. In the opinion of the authors, the leadership displayed by tour guides during the event, maximised the survivability of their clients. The actions of a variety of people on the boat back to the mainland allowed basic, yet very effective, first aid principles to be implemented. Too often we forget the significance of simple but timely interventions applied effectively at the earliest opportunity.

This event would have overwhelmed the resources of the New Zealand burn service if it were not for the collegiality displayed with our Australian colleagues, who again displayed our close alignment and willingness to support each other, despite their own local demands following the bush fires of 2019.

As deeply affected as health professionals were by this event, we recognise that this pales in comparison to the trauma experienced by patients and their families. Our thoughts are with them all.

The authors would like to thank the following individuals for their assistance in reviewing this manuscript:

- Professor Shane Cronin, Professor of Vulcanology, Faculty of Science, University of Auckland, NZ.
- Mr Paul Baker, Plastic, Reconstructive and Burns Surgeon, Middlemore Hospital, Auckland, NZ.
- Dr Francois Stapelberg, Specialist Anaesthetist, Middlemore Hospital and Chair, ANZBA Education Committee.

## REFERENCES

1. Witham C. Volcanic disasters and incidents: A new database. *Journal of Volcanology and Geothermal Research*; 2005. p. 191-233.
2. Eisele J. Deaths during the May 18, 1980, eruption of Mount St Helens. *New England Journal of Medicine*; 1981. p. 931-6.
3. Yamamoto T, Takarada S, Suto S. Pyroclastic flows from the 1991 eruption of Unzen Volcano, Japan. *Bulletin of Volcanology* 1993. p. 166-75.
4. Brown SK, Jenkins SF, Sparks RSJ, Odbert H, Auker MR. Volcanic fatalities database: Analysis of volcanic threat with distance and victim classification. *Journal of Applied Volcanology: Journal of Applied Volcanology*; 2017.
5. Baxter PJ, Gresham A. Deaths and injuries in the eruption of Galeras volcano, Colombia, 14 January 1993. *Journal of Volcanology and Geothermal Research*; 1997. p. 325-38.
6. Baxter PJ, Jenkins S, Seswandhana R, Komorowski JC, Dunn K, Purser D, et al. Human survival in volcanic eruptions: Thermal injuries in pyroclastic surges, their causes, prognosis and emergency management. *Burns: Elsevier Ltd and International Society of Burns Injuries*; 2017. p. 1051-69.
7. Letham-Brake M. Geological constraints on fluid flow at Whakaari volcano (White island); Masters degree thesis; University of Canterbury; 2013
8. Geonet. Volcanic alert levels [Internet]. Geological hazard information for New Zealand; Date unknown [cited 2021 Apr 30]. Available from: <https://www.geonet.org.nz/about/volcano/val>.
9. Werner C, Hurst T, Scott B, Sherburn S, Christenson BW, Britten K, et al. Variability of passive gas emissions, seismicity, and deformation during crater lake growth at White island volcano, New Zealand, 2002–2006. *Journal of Geophysical Research: Solid Earth*. 2008; 113(B1).
10. Christenson BW, White S, Britten K, Scott BJ. Hydrological evolution and chemical structure of a hyper-acidic spring-lake system on Whakaari/White island, NZ. *Journal of Volcanology and Geothermal Research*; 2017. p. 180-211.
11. Mayer K, Scheu B, Gilg HA, Heap MJ, Kennedy BM, Lavallée Y, et al. Experimental constraints on phreatic eruption processes at Whakaari (White island volcano). *Journal of Volcanology and Geothermal Research: The Authors*; 2015. p. 150-62.

12. Cronin SJ, Stewart C, Zernack AV, Brenna M, Procter JN, Pardo N, et al. Volcanic ash leachate compositions and assessment of health and agricultural hazards from 2012 hydrothermal eruptions, Tongariro, New Zealand. *Journal of Volcanology and Geothermal Research*; 2014. p. 233-47.
13. Cronin SJ. Personal communication.
14. Baxter PJ. Medical effects of volcanic eruptions. *Bulletin of Volcanology*; 1990. p. 532-44.
15. Wulff W, Zuber N, Alkidas A, Hess RW. Ignition of fabrics under radiative heating. *Combustion Science and Technology*; 1973. p. 321-34.
16. Rosenbaum JGaW, R.B., Jr. Summary of eyewitness accounts of the May 18 eruption. U S Geological Survey Professional Paper; 1981. p. 53-67.
17. Carfora A, Campobasso CP, Cassandro P, La Sala F, Maiellaro A, Perna A, et al. Fatal inhalation of volcanic gases in three tourists of a geothermal area. *Forensic Science International: Elsevier Ireland Ltd*; 2019. p. e1-e7.
18. Bergin CJ, Wilton S, Taylor MHG, Locke M. Thoracic manifestations of inhalational injury caused by the whakaari/white island eruption. *Journal of Medical Imaging and Radiation Oncology*; 2021. p. 1-8.
19. Hudspeth J, Rayatt S. Treatment of minor burns: Authors' reply. *Bmj*; 2004. p. 292.
20. ESR. Institute of environmental science and research ltd. Christchurch science centre, 27 Creyke Road, Ilam 8041, NZ.
21. Hatzifotis M, Williams A, Muller M, Pegg S. Hydrofluoric acid burns. *Burns*; 2004. p. 156-9.
22. Mckee D, Thoma A, Msc M, Bailey Md Msc K, Fish J, Phd M. A review of hydrofluoric acid burn management mechanism of injury. *Plast Surg*; 2014. p. 95-8.
23. Mclvor ME. Delayed fatal hyperkalemia in a patient with acute fluoride intoxication. *Annals of emergency medicine*; 1987. p. 1165-7.
24. Palao R, Monge I, Ruiz M, Barret JP. Chemical burns: Pathophysiology and treatment. *Burns: Elsevier Ltd and International Society of Burns Injuries*; 2010. p. 295-304.
25. Walker PF, Buehner MF, Wood LA, Boyer NL, Driscoll IR, Lundy JB, et al. Diagnosis and management of inhalation injury: An updated review. *Critical Care: Critical Care*; 2015. p. 1-12.
26. Blue Eagle, NP305 respirator®. Blue Eagle Safety, 282 Heping Second Rd, Kaohsiung 80651, Taiwan.
27. Blue Eagle, RC205 charcoal filters®. Blue Eagle Safety, 282 Heping Second Rd, Kaohsiung 80651, Taiwan.
28. Li Y, Kawamura Y, Fujiwara N, Naka T, Liu H, Huang X, et al. *Chryseobacterium miricola* sp. Nov., a novel species isolated from condensation water of space station mir. *Systematic and applied microbiology*; 2003. p. 523-8.
29. Opota O, Diene SM, Bertelli C, Prod'hom G, Eckert P, Greub G. Genome of the carbapenemase-producing clinical isolate *elizabethkingia miricola* em\_chuv and comparative genomics with *elizabethkingia meningoseptica* and *elizabethkingia anophelis*: Evidence for intrinsic multidrug resistance trait of emerging pathogens. *International Journal of Antimicrobial Agents*; 2017. p. 93-7.

## A beginner's guide to in-flight medical emergencies

### Gareth Jones, MBBCh, BSc

#### Anaesthesia Provisional Fellow, Middlemore Hospital, Auckland, New Zealand

Dr Gareth Jones graduated from Cardiff University and started anaesthesia training in South Wales before moving to New Zealand. He is currently undertaking a burns anaesthesia fellowship and has developing interests in trauma anaesthesia and medical education.

### Nicola Emslie, MBChB, MAvMed, FAFOEM

#### Occupational Physician, Auckland, New Zealand

Dr Nicole Emslie is an occupational physician with an interest in aviation medicine, having worked with a commercial airline for several years, and providing occupational health support to an Auckland-based rescue helicopter service. She is soon to take up an occupational medicine role at Middlemore Hospital in Auckland.

### Dean Bunbury, MSc Lond., MBBS Qld., BSc, FANZCA

#### Consultant Anaesthetist, Middlemore Hospital, Auckland, New Zealand

Dr Dean Bunbury is a consultant anaesthetist at Middlemore Hospital in Auckland. His clinical interests include paediatric anaesthesia, pre-hospital medicine and epigenetics. He is an honorary senior lecturer at the University of Auckland and current chair of the ACCUTE SIG.

## INTRODUCTION

Estimates from 2019 suggest that more than 4.3 billion passengers travel by air annually. This figure has increased every year since 2009<sup>1</sup>. It is inevitable that some of these passengers will suffer an in-flight medical event (IME).

The true incidence of IMEs is difficult to accurately measure because of the limitations in reporting systems<sup>2,3</sup>. Studies typically focus on individual airlines and tend to be retrospective. The best available estimates suggest rates between 16 to 130 IMEs per million passengers. This translates to between 68 000 and 59 000 IMEs worldwide annually. A recent retrospective review of a large Australian airline demonstrated one IME for every 40 flights<sup>4-7</sup>.

The International Air Transport Association (IATA) suggests that in the event of a serious injury or illness during flight, the second step, after calling ground based medical support (GBMS), should be to "solicit the aid of a volunteer such as a physician"<sup>8</sup>. Doctors are estimated to provide assistance to between 45-55 per cent of passengers experiencing an IME<sup>4,5,7,9</sup>. Providing medical assistance during flights can be a stressful experience, even for experienced physicians<sup>10</sup>. Ergonomic and human factor issues contribute to challenging patient management at 35,000 feet. Additional stressors include the logistical difficulties of treating a patient in a cramped airplane environment, the distance to any advanced ground based medical services, language barriers, fatigue, and uncertainty around the legal and ethical obligations of the physician volunteer<sup>10-12</sup>.

## PATHOPHYSIOLOGICAL IMPLICATIONS OF FLIGHT

Commercial planes operate at a cruising altitude of 30,000 to 40,000 feet, with cabins required to be pressurised to an altitude of between 5000 to 8000 feet<sup>11,13</sup>. According to Boyles law, the volume that a gas occupies is inversely proportional to its surrounding pressure. Thus, in a cabin pressurised to 8000 feet, there is a 30 per cent increase in gas volume within enclosed spaces, which can impact physiological and non-physiological gas-containing spaces within passengers<sup>14</sup>. In the healthy passenger this may result in abdominal or middle ear discomfort and occasionally tympanic perforation<sup>13</sup>. It is a more significant issue in those having had recent surgical procedures, or with air-filled medical devices in situ, such as cuffed tracheostomy tubes, urinary catheters and enteral feeding tubes. To prevent rupture secondary to expanding air, the cuffs should, if not contra-indicated, be filled with water during the flight<sup>13</sup>. Most commercial airlines have strict guidance for travel following surgery, and the British Civil Aviation Authority recommends delaying travel following ophthalmic, gastrointestinal and neurosurgical procedures (along with others) to avoid the risk of pathological gas expansion<sup>15,16</sup>. A history of recent pneumothorax, cystic lung disease or chronic pneumothorax puts the passenger at risk of flight-related pneumothorax<sup>17</sup>.

At a cabin pressure of 8000 feet there is a decrease in the arterial oxygen partial pressure from 95mmHg to 60mmHg, with a reduction in passengers mean arterial oxygen saturation from 97 per cent to 93 per cent<sup>18</sup>. While this is not likely to represent a significant issue in the healthy passenger, it could have a significant impact on the passenger with pre-existing cardio-pulmonary disease. Conditions such as chronic obstructive pulmonary disease

(COPD), pulmonary hypertension, valvular heart disease, coronary artery disease and sickle cell anaemia can all be exacerbated by systemic hypoxia. In patients with pre-existing cardiopulmonary disease The British Thoracic Society currently recommends a hypoxic challenge (FiO2 0.15 for 20 minutes followed by an arterial blood gas) as a screening tool for identifying patients who may require supplemental oxygen in-flight<sup>19</sup>.

There is a well-documented association between long-haul (more than eight-hour duration) air travel and venous thromboembolism (VTE)<sup>20</sup>. There is a strong link between prolonged immobility and the development of VTE, with passengers seated in aisle seats having a demonstrably lower risk than those in non-aisle seats<sup>21</sup>. Individual risk factors such as obesity, the oral contraceptive pill and hypercoagulable states also place an individual at elevated risk. VTE symptoms are usually experienced after the flight has completed. However, passengers on long flights, or those with multiple legs and short stop overs, are a risk of developing symptoms during the flight itself<sup>22,23</sup>.

The risk of communicable diseases on flights has been brought into sharp relief by the coronavirus pandemic. Close proximity to multiple individuals for a prolonged period of time potentially exposes individuals to infectious diseases of all natures. Outbreaks of tuberculosis, SARS and influenza have all been reported aboard aircraft<sup>13</sup>. There is limited evidence to quantify the risk of infectious disease transmission during commercial flights. Available data would suggest that the risk is greatest if the ventilation system becomes non-operational and if sitting within two rows of an infectious individual for more than eight hours<sup>24</sup>.

## ETHICAL AND LEGAL CONSIDERATIONS

The authors would argue that all doctors have an ethical duty to attend a request for medical assistance and render care that they are qualified to provide. The Medical Council of New Zealand (MCNZ) states that:

“If asked to attend a medical emergency . . . a doctor must respond. This is both an ethical and legal obligation . . . If a doctor chooses not to attend he or she may be required to defend that decision in the event of a charge of professional misconduct or criminal prosecution<sup>25</sup>.”

The Australian standpoint, outlined in clause 3.5 of “Good Medical Practice”, is slightly more ambiguous:

“Good medical practice involves offering assistance in an emergency that takes account of your own safety, your skills, the availability of other options and the impact on any other patients under your care . . .<sup>26</sup>”

The Good Samaritan Law in Australia ensures physicians who have volunteered their skills during an emergency are not liable. However, this does not exempt them if their interventions are proven to be demonstrably negligent, impaired or intentionally harmful<sup>27</sup>. The MCNZ also specifically acknowledges that “there are situations where a doctor . . . should not attend a medical emergency”. This includes having drunk alcohol, taken “substances to a level that may adversely influence the doctor’s level of competence” and “excessive fatigue”<sup>25</sup>.

The legalities surrounding the provision of medical services during an international flight are complex. Before offering assistance, a medical volunteer should consider if they are impaired in any way. A volunteer could be subject to the laws of the country that the plane is registered in, the country of destination and/or the country the plane was flying over at the time. However, to date there are no reports of individual physicians being found liable for assisting an unwell traveler<sup>28</sup>. Additionally, if an airline requests medical assistance it will normally accept liability associated with the request, and some airlines have a form that can be made available to treating physicians outlining the liability aspect<sup>28</sup>.

## RESOURCES AND LOGISTICS

A commercial plane can be considered an unfamiliar, isolated and resource scarce environment to the physician volunteer offering medical assistance. However, flight medical kits, aircrew training and the availability of ground based medical support (GBMS) provide options for support that can be utilised.

### Medical equipment and staff training

A doctor can request access to the on-board medical kit when attending an IME. Despite the lack of an international standard for commercial aircraft, the International Air Transport Association (IATA) has published a manifest of recommended medical equipment (in addition to a basic first aid kit) to be carried on board all passenger carrying flights (see Table 1)<sup>8</sup>. Most major carriers will have such a kit on board. Variations can be expected between airlines and with domestic and regional aircraft. The carriage of an automated external defibrillator (AED) is determined by each airline, but they are frequently available<sup>29,30</sup>. There will be emergency oxygen bottles on board, but amounts vary. They are usually limited to providing flows between 2-4 L/min<sup>11,31</sup>.

It is reasonable to expect cabin crew to be trained in basic first aid, cardio-pulmonary resuscitation (CPR) and the operation of any AED on board<sup>7</sup>. In New Zealand the flight attendants can link with GBMS and offer

further interventions including the administration of sublingual glyceryl trinitrate (GTN), inhaled salbutamol and epinephrine autoinjectors. Aircrew can also be used as translators and offer logistical advice, including identifying the best locations to treat an individual and how to move incapacitated passengers from their mid-row seats<sup>8</sup>.

**Table 1. IATA recommended equipment and drugs for a medical emergency kit<sup>8</sup>**

Equipment	Drugs
Sphygmomanometer	Epinephrine 1:1000
Stethoscope	Epinephrine 1:10,000
Oropharyngeal airways	Antihistamine (injectable)
Syringes and needles	Anti-psychotic drug
IV cannulae and giving set	Dextrose 50% 50 ml
Antiseptic wipes	Nitroglycerin (tablets or spray)
Tourniquet	Major analgesic (oral or injectable)
Sharps disposal box	Sedative anticonvulsants
Gloves, surgical mask	Bronchial dilator (inhaled)
Urinary catheter	Antiemetic (oral or injectable)
Tape and gauze	Atropine (injectable)
Emergency tracheal catheter	Adrenocortical steroid (oral or injectable)
Umbilical cord clamp	Diuretic (injectable)
Thermometer	Sodium Chloride 0.9% 1000ml
Torch	Aspirin (oral)
Bag-valve mask	Beta blocker (oral)

### Ground-based medical support

Most modern airlines are supported by a dedicated ground based medical support service<sup>11</sup>. The flight crew will often have contacted GBMS prior to asking for medical assistance<sup>8,11,31</sup>. They are third parties who specialise in the provision of advice for in-flight medical emergencies and will provide advice to the cabin crew, pilot and on-board volunteers. Should a conflict arise between the GBMS and the medical volunteer the crew will usually comply with the ground-based recommendation<sup>31</sup>.

### Logistics

Getting access to the patient may be a challenge, particularly if they are not in an aisle seat. Working as a team with the cabin crew and utilising their knowledge is key.

If the patient is conscious and in an aisle seat, then the safest approach would be to make the initial assessment in situ. Cabin crew assistance with moving other passengers to access patients in middle or window seats may be required. Were they to require further assessment, procedures or ongoing monitoring then it may be appropriate to find a seat with more space, in an exit row, a different class, or by moving to the galley.

In the case of the unconscious patient a rapid ABCD assessment will enable a decision as to the most appropriate action. In the case of a presumed syncopal episode, lying the passenger down on empty seats is possibly the most straightforward way of achieving a supine position. If further access is required for any reason, it is recommended that the person be moved to an exit aisle or the galley, even if that involves a distance of several metres<sup>32,33</sup>. Exactly how this is achieved will be context dependent and the expertise of the cabin crew can often be relied upon. Techniques used by the aircrew may be familiar to the volunteer anaesthetist. This could include the use of a blanket and bystander passengers acting as orderlies to carry the patient to a more ergonomic area.

An unconscious patient in a toilet provides another logistical challenge. Cabin crew will have protocols to access the patient and working with them to gain access to the patient is crucial. Assessment and treatment should proceed once the patient is outside of the toilet cubicle.

A paucity of guidance is available regarding the optimal management of an unconscious morbidly obese individual during an IME. The safety of the aircrew and the volunteers needs to be considered if moving the patient is attempted.

### Documentation

Documentation of IMEs has been shown to be highly variable across airlines<sup>34</sup>. The IATA recommends that events during IMEs are documented completely by cabin crew and any responding medical professional<sup>9</sup>. Complete documentation is not only part of good medical practice, but it will also aid any ground based medical services in making a thorough assessment and be important if there were to be any subsequent legal issues. It is recommended that the medical volunteer documents the whole event on the form provided by the airline and keeps their own copy<sup>28,34</sup>.

### DIVERSION

Diversion in this context describes changing the landing destination of the flight due to an IME. It requires consideration of both medical and operational issues and may be the cause of some stress to the volunteer physician.

From a physician's standpoint a plane is an unfamiliar environment in which to manage a medical emergency. The medical benefit of diversion needs to be assessed on the basis of the differential diagnoses, the patient's physiological status, the ability to stabilise the patient with the available resources, and the potential time savings gained by diverting to an alternative airport.

Operational issues, which are myriad, could rightfully be expected to be outside the knowledge of the medical volunteer. The weather, potential diversion destinations, the type of medical facilities available there, the distance to them and the time saved by diverting there, all demand consideration. Additionally, long-haul flights often carry more fuel at take-off than is safe to land with. Therefore, a diversion may require the dumping of significant amounts of fuel into the atmosphere, with financial and ecological implications. Other costs are also factored into the decision-making process. A single diversion has been estimated to cost an airline anywhere from \$US30,000-725,000<sup>11,35</sup>.

Diverting an aircraft for an IME is an uncommon occurrence. Epstein et al reports only 21 flight diversions out of 131,890 total flights, which corresponds to less than 1 per cent of all reported IMEs. Other large studies report slightly higher diversion rates of 2.8 per cent and 7.3 per cent<sup>5,7,35</sup>.

The ultimate decision to divert lies with the pilot in command of the aircraft. The medical volunteer's role is to provide advice, in conjunction with the GBMS, on the clinical state of the patient and the potential medical benefits of diverting. The pilot's responsibility is then to consider relevant issues, including plane and passenger safety, advice from GBMS and physician volunteers, and financial implications. There may be events which make the decision straightforward, such as a patient having return of spontaneous circulation (ROSC) following a VF cardiac arrest. However, the majority of IME cases are not as definitive as this, and even if the aircraft is diverted, there is a relatively low rate of subsequent patient transport and admission to hospital, 25 per cent and 8 per cent respectively<sup>5</sup>.

### SPECIFIC MEDICAL EMERGENCIES

Quantifying the overall incidence and nature of IMEs is difficult. The relevant studies are usually retrospective, with no centralised or standardised reporting system<sup>36</sup>. Diagnoses are often drawn from incomplete and highly variable documentation, or the reports of non-medically trained cabin crew<sup>34</sup>. Additionally, only a small number of all passengers are subsequently treated by ground based medical services, and even fewer are transported to hospital, compounding the difficulty in confirming specific diagnoses<sup>5,7</sup>. With these challenges in obtaining reliable diagnostic information, many IMEs are classified by symptomology rather than presumed causative pathology. Table 2 outlines the most common causes of an IME found by a retrospective review of more than 11,000 calls to a ground based medical service (GBMS) between 2008 and 2010<sup>5</sup>.

#### Syncope

Syncope is reported to be the cause of an IME in 37 per cent to 52 per cent of cases<sup>5,35,37</sup>. It can be benign or the result of serious underlying pathology. The patient is likely to initially look pale and clammy, be bradycardic with a thready pulse.

**Table 2. Top five In-flight medical emergencies by category and outcome<sup>5</sup>**

Category	Number (%)	Diversion (%)	Admitted to hospital (%)	Death (%)
All	11,920	875 (7.3)	901 (8.6)	36 (<0.1%)
Syncope or presyncope	4463 (37.4)	221 (5.0)	267 (6.5)	4
Respiratory	1447 (12.1)	81 (5.6)	141 (10.6)	1
Nausea or vomiting	1137 (9.5)	56 (4.9)	61 (6.1)	0
Cardiac	920 (7.7)	169 (18.4)	162 (21.0)	0
Seizures	689 (5.8)	83 (12.0)	75 (12.5)	0

Typical humidity levels in airliners are around 2 per cent and dehydration secondary to the recirculation of arid air is common<sup>13,20</sup>. This is likely to be compounded by the mildly hypoxic environment, long periods of immobility, alcohol consumption and fatigue<sup>18,38</sup>. Lying the syncopal patient down, either across seats or in the aisle, and elevating their legs, may be sufficient to improve the situation. Supplemental oxygen and oral or intravenous fluids may also be appropriate. Failure to rapidly improve should trigger consideration of other, potentially more serious causes<sup>38,39</sup>.

#### Neurological

Neurological symptoms are fortunately uncommon. Seizures, stroke and headache make up less than 9 per cent of all IMEs<sup>11</sup>. Self resolving seizures with rapid recovery will usually require no further intervention except simple monitoring. Any previous history should be sought and adherence to anti-seizure medications ascertained. It may be appropriate to administer the patient's own medication if they have missed a dose while travelling.

The management of someone who does not regain consciousness revolves around an initial airway, breathing and circulation assessment with provision of supplemental oxygen. A collateral history should be sought, as this may represent a post-ictal phase with recovery over time to be expected. Liaison with GBMS should be initiated early to consider options if consciousness does not recover. Multiple seizures, the development of status epilepticus or acute stroke symptoms and signs should prompt and rapid consideration of diversion as treatment options on a flight are extremely limited<sup>28</sup>.

Hypoglycaemia can present with a diverse range of symptoms including seizure. It can be easily excluded with a capillary glucometer, which may be present in the plane's medical kit. An alternative would be to ask other passengers for a glucometer that could be borrowed. Medical alert bracelets can be helpful in this scenario and should be looked for. Hypoglycaemia should be managed with oral or intravenous glucose as clinically appropriate<sup>38</sup>.

#### Cardiac

Chest pain could represent anything from simple indigestion to a myocardial infarction and is the cause of between 6-12 per cent of all IMEs<sup>11</sup>. A focused history, assessment of risk factors for significant coronary disease or pulmonary embolism and clinical examination is key. An ECG may be available in the medical kit and supplemental oxygen could be required to mitigate the hypoxia associated with altitude. ECG changes, persistent chest pain unrelieved by antacids, simple analgesics or nitrates and abnormal observations, may be a reason to recommend medical diversion, although subsequent hospital admission is uncommon<sup>5,11</sup>. Liaison with GBMS is key if significant ongoing cardiac pathology is suspected. If there are concerns regarding arrhythmia then in flight AEDs have been shown to be a safe option in-flight for monitoring cardiac rhythm and are straightforward to apply and use<sup>40</sup>.

#### Respiratory

The hypoxia associated with flying places patients with pre-existing cardiopulmonary conditions at risk of acute dyspnoea. <sup>20</sup> Approximately 12 per cent of all IMEs have been classified as having a respiratory basis. <sup>5</sup>

Consideration should be given to the underlying pathology. Provision of supplemental oxygen may be of benefit, but with the knowledge that the plane will only have a finite supply. Use of the lowest possible flow rate would be advisable and a calculation of the available oxygen supply may help to guide diversion decisions.

Bronchodilators are likely to be available in the medical kit if required. Decompression of a suspected pneumothorax would be indicated in the deteriorating patient and if within the clinician's competence level.

In extremis, and as a temporising measure, the medical volunteer could also request lowering of the flights altitude to reduce the impact of hypoxaemia<sup>38</sup>.

### Trauma

Blunt force trauma or scalds from hot beverages are not uncommon on commercial aircraft<sup>5,41</sup>. Most are amenable to treatment using the first aid kit aboard all aircraft although consideration should always be given to the nature of the injury and its effect on that particular passenger. Some incidents require a heightened level of concern, such as the elderly anticoagulated passenger who has had a heavy bag fall on their head. Frequent re-assessment, liaison with the cabin crew and consideration of a diversion may be appropriate if there were to be a clinical deterioration in such a case<sup>38</sup>.

### Psychiatric

Approximately 3 per cent of all IME reported are due to either psychiatric conditions or acute intoxication<sup>11,42</sup>. They can be difficult to manage, cause distress to other passengers and pose significant safety issues<sup>20,43</sup>. The responding physician should remain aware that organic pathology, such as hypoglycaemia or hypoxia, could be the cause of the symptoms. Conversely, acute severe anxiety, can also mimic a variety of physical symptoms such as chest pain and shortness of breath.

Anxiety can often be managed with simple calming measures and reassurance. Medical kits are unlikely to contain sedatives however administration of the patients own anxiolytic medications may be helpful. If simple de-escalation measures fail, then advice from GBMS to ensure the safety of the plane, crew and all passengers should be sought<sup>38</sup>.

### Obstetric

Obstetric emergencies in flight can be extremely distressing for everyone involved. The medical volunteer is unlikely to have significant training in this area of medicine and the parent(s) are likely to be extremely anxious. Fortunately, they only constitute approximately 0.7 per cent of all IMEs<sup>11</sup>. More than 60 per cent of cases involve pregnant women of less than 24 weeks gestation with signs of miscarriage<sup>5</sup>. Flying beyond 36 weeks' gestation for single pregnancies, or 32 weeks for multiple, is not recommended by airlines<sup>15</sup>. There is little that the responding medical volunteer can practically offer except monitoring of vital signs and providing reassurance. Any concerns from the responding medical volunteer should prompt a call to GBMS<sup>11</sup>.

### Allergic reaction

Two to four per cent of all IMEs are allergic reactions, but fortunately they are rarely serious<sup>11,44</sup>. A history of serious allergy or medical alert bracelet should prompt a request for the medical kit and identification and removal of the allergen from the area. Epinephrine should be available in the medical kit and cabin crew may be trained to administer intra-muscular doses via an autoinjector<sup>11</sup>.

### Paediatric

Paediatric cases contribute to between 9.15 to 15 per cent of all IMEs<sup>9,41,45-47</sup>. While they can suffer from any of the symptoms described for adults, the burden of significant pre-morbid conditions in children is significantly lower and the frequency of presenting complaints reflects that. A recent large retrospective study found that the most common IMEs in children were nausea and vomiting (33.9 per cent), fever or chills (22.2 per cent), allergic (5.5 per cent), abdominal pain, (4.7 per cent) gastroenteritis (4.5 per cent) and syncope (3.5 per cent)<sup>45</sup>. Seizure and dyspnoea are leading causes of medical diversion for paediatric medical events<sup>45</sup>. The physician's kit should be requested but obtaining a collateral history and administering the patient's own medication may be the most effective treatment available.

### Cardiac arrest

Cardiac arrest accounts for 0.3 per cent of all IMEs but 86 per cent of all in flight deaths<sup>5,38</sup>. Up to 31 per cent of in-flight cardiac arrests have VF or VT as the first recorded rhythm and appropriate early defibrillation has resulted in survival to hospital discharge rates of 50 per cent<sup>48</sup>. There have been no documented survivors if the rhythm is initially asystole or idioventricular<sup>32</sup>.

When attending a passenger in cardiac arrest, the medical volunteer should immediately request the AED, apply it as soon as possible and utilise standard basic life support (BLS) principles. If an AED is available, then you can expect at least one member of the cabin crew to be trained in its use<sup>28</sup>. It may be appropriate for the AED to be applied and utilised with the patient in their seat if there has been no opportunity to move them safely. Expert providers can utilise advanced resuscitation equipment and skills, remembering that early effective CPR and defibrillation of a shockable rhythm remain the only interventions proven to improve survival rates<sup>32</sup>.

Access to the patient may be difficult and the first priority should be to move them to a flat area with enough room to effectively provide CPR and attach an AED. Consensus guidelines produced in 2018 suggest that

the galley is the most appropriate place to perform CPR however, the aisle could be utilised, with cardiac compressions performed from overhead<sup>33</sup>.

Any decisions around the cessation of CPR should be made in co-operation with the medical volunteer, GBMS and the captain, who has the ultimate responsibility for the safety of the aircraft. It is likely that the captain will request a temporary cessation of resuscitation efforts during the very final phases of landing (for example, the final 1000 feet of descent until the aircraft vacates the runway), to ensure that cabin crew and any passengers assisting are safely restrained in their seats during this critical phase of flight.

International consensus guidelines suggest that if ROSC has not been achieved within 20-30 minutes, with no reversible causes identified, then it would be reasonable to cease resuscitation<sup>33</sup>. The IATA 2018 guidelines suggests that CPR should be continued until one of the following criteria are met:

1. Spontaneous breathing and circulation resume; or
2. It becomes unsafe to continue CPR (for example, moderate and severe turbulence and/or forecasted difficult landing after liaising with the flight crew); or
3. All rescuers are too exhausted to continue; or
4. The aircraft has landed and care is transferred to emergency medical services; or
5. The person is presumed dead: if CPR has been continued for 30 minutes or longer with no signs of life within this period, and no shocks advised by an on board Automated External Defibrillator (AED), the person may be presumed dead, and resuscitation ceased<sup>49</sup>.

What to do following cessation of resuscitation efforts depends on the airline's policy, and it is best to defer to cabin crew on this matter. Diversion once resuscitation efforts have ceased is not recommended<sup>32</sup>. It would potentially impact on crew and passenger safety, there is no medical benefit to be gained from landing sooner, and the deceased's body will potentially need to be repatriated to the original destination regardless. Table 3 outlines the suggestions from the IATA as to the next actions. Cabin crew should be aware of this protocol<sup>49</sup>.

**Table 3. Guidelines for management of a deceased passenger during flight**  
Adapted from IATA guidelines<sup>49</sup>.

Advise the captain immediately.
Put the deceased in a body bag (if available) or cover with a blanket up to the neck.
Move the deceased to a seat – if available, one with few other passengers nearby.
Restrain the deceased with seat belt or other equipment.
Request contact information from travelling companions.
Disembark other passengers first and make sure the family members stay with the body.
Do not disembark the body until the proper local authority has arrived.

Flight crew are unable to declare an individual deceased. A volunteer doctor could pronounce death however it is suggested that the volunteer leave formal pronouncement to attending ground crew on landing<sup>13,28</sup>.

There is no international law or consensus which details the applicability of a Do Not Resuscitate (DNR) order being presented to the cabin crew or medical volunteer by relatives or friends. The volunteer needs to make a decision they feel is in the best interests of the patient based on the information they have at the time. If they decline to perform CPR it is possible that cabin crew may disagree and attempt resuscitation, which may include calling for an alternative medical professional<sup>28</sup>.

## CONCLUSION

Flight places a number of unique physiological stresses upon the human body. As the number of people flying is increasing, so is the likelihood of one of the readers of this article being asked to attend an in-flight medical event. Table 4 outlines the steps a volunteer could take when responding to a request for assistance.

The majority of in-flight medical events will be of a non-serious nature or exacerbations of chronic conditions, which can be managed with the on-board medical kit, advice from ground-based medical services and without requiring diversion. Assuming you are not impaired, it could be considered an ethical obligation to render what medical aid you can if requested to do so.

The effective management of human factors has been well documented as being crucial to successfully negotiating an anaesthesia crisis<sup>12</sup>. Parallels can be drawn between the management of IMEs and emergencies in the operating room, making teamwork, communication and the maintenance of situational awareness, key to successful resolution of an IME. The role of the medical volunteer is to utilise expert knowledge, provide advice to the cabin crew and pilot, liaise with the GBMS, and to undertake interventions within their individual scope of practice.

An in depth understanding of physiology and the pathophysiological implications of altitude, advanced resuscitation skills and the awareness of the importance of human factors during crisis management mean the volunteer anaesthetist is well equipped to deal with medical emergencies on commercial flights.

#### Table 4. Suggested actions for attending an in-flight medical emergency

Adapted from *Medical Emergencies: Managing in-flight medical events*<sup>28</sup>.

Decide if you are in a condition (for example, not impaired) to respond to a medical emergency.
Identify yourself to cabin crew with proof of medical credentials if available.
You can ask to see the information on liability provided by the airline.
Ask a member of the cabin crew to stay while you assess the patient.
Introduce yourself to the patient and conduct a focused history and examination.
If the situation appears serious request the cabin crew contact GBMS, ask for the medical kit and the AED.
Where possible treat the passenger while seated.
If resuscitation is required arrange transport to the most appropriate area, usually the galley.
Consider the clinical need for a medical diversion and communicate that to cabin crew and GBMS.
Make accurate notes on the airlines documentation and keep a copy yourself.

## REFERENCES

1. Air transport, passengers carried | Data [Internet]. [cited 2021 May 4]. Available from: <https://data.worldbank.org/indicator/IS.AIR.PSGR?end=2019&start=1970&view=chart>
2. Goodwin T. In-flight medical emergencies: An overview. Vol. 321, British Medical Journal. BMJ Publishing Group; 2000. p. 1338–41.
3. Chandra A, Conry S. In-flight medical emergencies. Vol. 14, Western Journal of Emergency Medicine. 2013. p. 499–504.
4. Kesapli M, Akyol C, Gungor F, Akyol AJ, Guven DS, Kaya G. Inflight Emergencies during Eurasian Flights. Journal of Travel Medicine. 2015 Nov 1;22(6):361–7.
5. Peterson DC, Martin-Gill C, Guyette FX, Tobias AZ, McCarthy CE, Harrington ST, et al. Outcomes of Medical Emergencies on Commercial Airline Flights. New England Journal of Medicine. 2013 May 30;368(22):2075–83.
6. Kim JH, Choi-Kwon S, Park YH. Comparison of inflight first aid performed by cabin crew members and medical volunteers. Journal of travel medicine. 2017 Mar 1;24(2).
7. Epstein CR, Forbes JM, Futter CL, Hosegood IM, Brown RG, Zundert AA van. Frequency and clinical spectrum of in-flight medical incidents during domestic and international flights. Anaesthesia and Intensive Care. 2019;47(1):16–22.
8. Iata. Medical Manual Edition 12 [Internet]. Available from: [www.iata.org/covid-19](http://www.iata.org/covid-19)
9. Baltsezak S. Clinic in the air? A retrospective study of medical emergency calls from a major international airline. Journal of Travel Medicine. 2008 Nov;15(6):391–4.
10. Is there a doctor on board. Minnesota Medicine, Minnesota Medical Association [Internet]. 2011 [cited 2021 Jun 10];25–32. Available from: <http://pubs.royle.com/publication/?i=71643&view=issueBrowser>
11. Martin-Gill C, Doyle TJ, Yealy DM. In-Flight Medical Emergencies: A Review. Vol. 320, JAMA – Journal of the American Medical Association. American Medical Association; 2018. p. 2580–90.
12. Jones CPL, Fawker-Corbett J, Groom P, Morton B, Lister C, Mercer SJ. Human factors in preventing complications in anaesthesia: a systematic review. Vol. 73, Anaesthesia. Blackwell Publishing Ltd; 2018. p. 12–24.
13. Donner HJ. Is There a Doctor Onboard? Medical Emergencies at 40,000 Feet. Vol. 35, Emergency Medicine Clinics of North America. W.B. Saunders; 2017. p. 443–63.
14. Gendreau MA, DeJohn C. Responding to Medical Events during Commercial Airline Flights. New England Journal of Medicine. 2002 Apr 4;346(14):1067–73.
15. Travel Clearance Guidelines Qantas Group Medical Travel Clearance Guidelines.
16. Assessing fitness to fly | UK Civil Aviation Authority [Internet]. [cited 2021 May 11]. Available from: <https://www.caa.co.uk/Passengers/Before-you-fly/Am-I-fit-to-fly/Guidance-for-health-professionals/Assessing-fitness-to-fly/>
17. Hu X, Cowl CT, Baqir M, Ryu JH. Air travel and pneumothorax. Vol. 145, Chest. American College of Chest Physicians; 2014. p. 688–94.
18. Humphreys S, Deymond R, Bali I, Stevenson M, Fee JPH. The effect of high altitude commercial air travel on oxygen saturation. Anaesthesia. 2005 May;60(5):458–60.

19. Coker R. Managing passengers with respiratory disease planning air travel: British Thoracic Society recommendations: British Thoracic Society Standards of Care Committee. Vol. 57, Thorax. BMJ Publishing Group Ltd; 2002. p. 289–304.
20. Silverman D, Gendreau M. Medical issues associated with commercial flights. [www.thelancet.com](http://www.thelancet.com). 2009;373.
21. Cesarone MR, Belcaro G, Nicolaides AN, Incandela L, de Sanctis MT, Geroulakos G, et al. Venous thrombosis from air travel: The LONFLIT3 study: Prevention with aspirin vs low-molecular-weight heparin (LMWH) in high-risk subjects: A randomized trial. Angiology. 2002;53(1):1–6.
22. Aryal KR, Al-khaffaf H. Venous thromboembolic complications following air travel: What's the quantitative task? A literature review. Vol. 31, European Journal of Vascular and Endovascular Surgery. Elsevier; 2006. p. 187–99.
23. Kesteven PJL, Robinson BJ. Clinical risk factors for venous thrombosis associated with air travel. Aviation Space and Environmental Medicine. 2001;72(2):125–8.
24. Mangili A, Gendreau MA. Transmission of infectious diseases during commercial air travel. Vol. 365, Lancet. Elsevier B.V.; 2005. p. 989–96.
25. Medical Council of New Zealand [Internet]. [cited 2021 May 14]. Available from: [www.mcnz.org.nz](http://www.mcnz.org.nz),
26. Board M. Good medical practice: a code of conduct for doctors in Australia Good medical practice: a code of conduct for doctors in Australia Good medical practice: a code of conduct for doctors in Australia-October 2020. 2020.
27. Gulam H, Devereux J. A brief primer on Good Samaritan law for health care professionals. Australian health review : a publication of the Australian Hospital Association. 2007;31(3):478–82.
28. MEDICAL EMERGENCIES: MANAGING IN-FLIGHT MEDICAL EVENTS Guidance Document Medical Emergencies: Managing In-flight Medical Events (Guidance material for health professionals). 2016.
29. Hinkelbein J, Schmitz J, Kerkhoff S, Eifinger F, Truhlar A, Schick V, et al. On-board emergency medical equipment of European airlines. Travel Medicine and Infectious Disease. 2021 Mar 1;40.
30. Sand M, Gambichler T, Sand D, Thrandorf C, Altmeyer P, Bechara FG. Emergency medical kits on board commercial aircraft: A comparative study. Travel Medicine and Infectious Disease. 2010 Nov;8(6):388–94.
31. Riou B, Ruskin KJ, Hernandez KA, Barash PG. CLINICAL CONCEPTS AND COMMENTARY Management of In-flight Medical Emergencies. 2008.
32. Truhlar A, Deakin CD, Soar J, Khalifa GEA, Alfonso A, Bierens JJLM, et al. European Resuscitation Council Guidelines for Resuscitation 2015. Section 4. Cardiac arrest in special circumstances. Resuscitation. 2015 Oct 1;95:148–201.
33. Hinkelbein J, Böhm L, Braunecker S, Genzwürker H v., Kalina S, Cirillo F, et al. In-flight cardiac arrest and in-flight cardiopulmonary resuscitation during commercial air travel: Consensus statement and supplementary treatment guideline from the German Society of Aerospace Medicine (DGLRM). Internal and Emergency Medicine. 2018 Jan 1;13(8):1305–22.
34. Sand M, Morrosch S, Sand D, Altmeyer P, Bechara FG. Medical emergencies on board commercial airlines: Is documentation as expected? Critical Care. 2012 Mar 7;16(2).
35. Sand M, Bechara FG, Sand D, Mann B. Surgical and medical emergencies on board European aircraft: A retrospective study of 10189 cases. Critical Care. 2009 Jan 20;13(1).
36. Ruskin KJ. In-flight medical emergencies: Who, what, and how many? Vol. 47, Anaesthesia and Intensive Care. SAGE Publications Inc.; 2019. p. 10–2.
37. Mahony PH, Myers JA, Larsen PD, Powell DMC, Griffiths RF. Symptom-based categorization of in-flight passenger medical incidents. Aviation Space and Environmental Medicine. 2011 Dec;82(12):1131–7.
38. Nable J v., Tupe CL, Gehle BD, Brady WJ. In-Flight Medical Emergencies during Commercial Travel. New England Journal of Medicine. 2015 Sep 3;373(10):939–45.
39. Baker SP, Brady JE, Shanahan DF, Li G. Aviation-related injury morbidity and mortality: Data from U.S. Health Information Systems. Aviation Space and Environmental Medicine. 2009 Dec;80(12):1001–5.
40. Page RL, Joglar JA, Kowal RC, Zagrodzky JD, Nelson LL, Ramaswamy K, et al. Use of Automated External Defibrillators by a U.S. Airline. New England Journal of Medicine. 2000 Oct 26;343(17):1210–6.
41. Alves PM, Nerwich N, Rotta AT. In-Flight Injuries Involving Children on Commercial Airline Flights. 2016.
42. Matsumoto K, Goebert D. In-flight psychiatric emergencies. Aviation Space and Environmental Medicine. 2001 Oct 1;72(10):919–23.
43. DeHart RL. Health issues of air travel. Vol. 24, Annual Review of Public Health. Annu Rev Public Health; 2003. p. 133–51.
44. Sánchez-Borges M, Cardona V, Worm M, Lockey RF, Sheikh A, Greenberger PA, et al. In-flight allergic emergencies. Vol. 10, World Allergy Organization Journal. BioMed Central Ltd; 2017.
45. Rotta AT, Alves PM, Nerwich N, Shein SL. Characterization of In-Flight Medical Events Involving Children on Commercial Airline Flights. Annals of Emergency Medicine. 2020 Jan 1;75(1):66–74.
46. Rotta AT, Alves PM, Mason KE, Nerwich N, Speicher RH, Allareddy V, et al. Fatalities above 30,000 feet: Characterizing pediatric deaths on commercial airline flights worldwide. Pediatric Critical Care Medicine. 2014 Oct 10;15(8):e360–3.
47. Moore BR, Ping JM, Claypool DW. Pediatric Emergencies on a US-Based Commercial Airline. 2005.
48. Brown AM, Rittenberger JC, Ammon CM, Harrington S, Guyette FX. In-flight automated external defibrillator use and consultation patterns. Prehospital Emergency Care. 2010;14(2):235–9.
49. IATA. Death on board guidelines [Internet]. 2018 [cited 2021 May 13]. Available from: <https://www.iata.org/whatwedo/safety/health/Documents/death-on-board-guidelines.pdf>



# Education

**NetworkZ: A multi-disciplinary team training initiative aiming to reduce unintended harm from surgery**

Jennifer M Weller, Jennifer Long, Alan F Merry

---

**Teaching medical students during clinical anaesthesia placements**

Jeremy Rogers, Jeremy Carman, Andrew Gardner, Ross MacPherson

---



## NetworkZ: A multi-disciplinary team training initiative aiming to reduce unintended harm from surgery

### Jennifer M Weller MD, MBBS, MClEd, FRCA, FANZCA

#### University of Auckland

Professor Jennifer Weller is head of the Centre for Medical and Health Sciences Education at the University of Auckland, and a specialist anaesthetist at Auckland City Hospital. She is on the editorial board for the *British Journal of Anaesthesia*. Her research includes workplace-based assessment, simulation, teamwork and patient safety. She leads a national, government-funded program aimed at establishing multidisciplinary simulation-based team training for surgical staff. Her research in workplace-based assessment explores both the psychometric properties of assessment tools and qualitative analysis of how these assessments work in clinical practice. Professor Weller holds positions with the Australian and New Zealand College of Anaesthetists in various education and research committees, with a current focus on competency-based education.

### Jennifer Long, BSc(Hons), PhD

#### University of Auckland

Dr Jennifer Long has a PhD in psychology and is a research fellow at the Centre for Medical and Health Sciences Education at the University of Auckland.

### Alan F Merry, MBChB, FANZCA, FFPANZCA

#### University of Auckland

Professor Alan Merry works in the Department of Anaesthesiology, Faculty of Medical and Health Sciences, University of Auckland and in the Department of Anaesthesia, Auckland City Hospital, Auckland, New Zealand.

## INTRODUCTION

### Teamwork and professional training

Surgery is delivered by teams and safe surgery depends on teamwork. Almost any surgical operation requires individuals with different skills and different perspectives to work effectively together towards a shared goal. Major surgery requires a particularly high level of co-ordination and communication.

Suboptimal teamwork and communication contribute to a situation where patients are harmed by surgery that is intended to help them. Jha et al<sup>1</sup> estimate that unintended patient harm is the 14th leading cause of global morbidity and mortality, comparable to diseases such as tuberculosis and malaria<sup>2</sup>. Surgery contributes a substantial proportion to the overall burden of this patient harm<sup>2</sup>, often through failures in communication. Communication failures are estimated to affect about 30 per cent of team interactions in operating theatres<sup>3</sup>, and to contribute to 43 per cent of surgical errors<sup>4</sup>. On the positive side, good teamwork is associated with better outcomes for patients, and improved information sharing between team members has been linked to reduced patient mortality and morbidity<sup>5</sup>.

Research on teams suggests that teamwork is facilitated when team members have a shared mental model of the collective task, when they trust each other, and when they communicate clearly, for example through acknowledging requests and closing the loop when tasks are complete<sup>6</sup>. Good teamwork and communication strategies can help healthcare team members navigate potential misunderstandings, co-ordinate activities efficiently and identify and communicate safety risks.

### The case for interprofessional training

Most healthcare education occurs in professional silos – doctors train with doctors, nurses with nurses, and pharmacists with pharmacists. Even in simulation-based training for emergency response, ANZCA's Effective Management of Anaesthetic Crisis (EMAC)<sup>7</sup> course is fundamentally uni-professional, and anaesthetists act the role of surgeons or nurses in scenarios. There is value in uni-professional training, but it represents a missed opportunity to develop critical teamwork and crisis skills that are shared and understood by everyone who needs to work together. Consider, by contrast, the efforts that go into sports team development for highly successful teams such as the New Zealand All Blacks or the Boston Red Sox. While specific tasks can be practised in silos, these highly skilled individuals must practise as a whole to become an expert team. Uni-professional training can lead to different language or strategies among different members of the team. Crisis communications function best when all team members recognise and understand the purpose of communication strategies and know how to contribute.

A further risk of siloed training is negative learning – if one professional group acts the part of another then misrepresentation of roles, or even negative stereotyping may occur. This may in turn undermine the development of mutual trust and respect for other professional groups<sup>6</sup>. Thus, there is every reason for teams that work together to undertake team training together.

Innovative training programs have been created for operating theatre teams<sup>9-10</sup>. For example, the Centre for Medical Simulation in Boston has been a leader in training of multidisciplinary operating theatre teams in a simulation centre, by integrating surgical tasks into existing anaesthesia simulators using models made within the unit. Commercially available simulators have also been used to enable team training for caesarean section or vaginal deliveries<sup>11</sup>.

In New Zealand (NZ), an initiative called NetworkZ has taken this idea further by working with a producer of simulation appliances to create highly realistic bespoke surgical models, and implementing multidisciplinary team training in situ, in the usual workplace of clinical teams across publicly funded hospitals in New Zealand.

## THE NETWORKZ PROGRAM

### Overview

The NetworkZ program seeks to improve patient safety by improving teamwork and communication. The combination of multidisciplinary participation, realism and in-situ delivery is unique compared to other programs available in Australia and New Zealand (see more on this in the following sections).

Learning and reflection is promoted through challenging clinical simulations and accompanying debriefs and through communication skills workshops.

### Box 1. Outline of a NetworkZ course

#### A typical half-day NetworkZ course proceeds through the following steps:

1. Introductions.
2. Familiarisation with the manikin.
3. Scenario 1.
4. Group debrief.
5. Communication talk\*.
6. Scenario 2.
7. Group debrief.
8. Wrap up and evaluation.
9. Post course-report – lessons learnt to take back to practice (teamwork, process and systems issues).
  - Currently there are four teamwork talks to select from: Closed loop communication; ISBAR; Speaking up and actively listening; and, Structured recaps.

### Core features of NetworkZ

#### Multi-disciplinary continuing medical education

NetworkZ courses cross professional boundaries and are multi-disciplinary from the design of scenarios to course delivery and debriefing. Teams that normally work together are trained together in their own operating theatres.

Course participants are drawn from the breadth of operating room roles: consultant surgeons (13 per cent), consultant anaesthetists (14 per cent), surgical trainees (7 per cent), anaesthetic trainees (5 per cent), nurses (39 per cent), anaesthetic technicians (12 per cent) and other staff such as healthcare assistants (9 per cent). In contrast to uni-professional simulations, participants act in their usual role, performing their usual tasks. The multi-disciplinary debriefing following the simulated scenario provides a rare opportunity for staff from different disciplines to share with each other their personal reflections and perspectives on the experience, what they struggled with and ideas for improvements to practice in the future.

With challenging and realistic simulations, communications between the team members rapidly move beyond role play to real interactions with co-participants. At debriefing, trained facilitators guide an exploration by participants into the way the team members work together, including their roles, assumptions and

understanding of the simulated situation. Emphasis is placed on the unique knowledge that each of them have, both in relation to their different professional backgrounds, and to the case in question. To this end the scenario briefs typically provide slightly different information to each individual, reflecting the clinical reality that different team members may have different information about a patient of which others in the team are unaware. This triggers conversations about how and why information was shared, or not. Debriefing following the simulation provides an opportunity for every team member to share their perspectives and insights on teamwork during the case. The aim is to foster open communication, understanding and respect for each other's unique contributions and promote respectful, expert teamwork.

### In situ delivery

NetworkZ simulations are run in participants' own operating theatres to maximise the relevance and realism of the training. In situ delivery obviates the need for access to a stand-alone simulation facility making it accessible for hospitals that do not have a local simulation facility, but also has other advantages. The in situ approach tests local response systems, equipment and protocols<sup>12</sup> and may identify latent patient safety threats that, left uncorrected, may pose a risk to the safety of future patients<sup>13</sup>. An audit of the threats identified in NetworkZ simulations between 2017 and 2019 identified that courses commonly identified gaps in crisis skills, verbal communication processes, common understanding of protocols, absent or malfunctioning equipment, uneven task distribution between team members and failure to use cognitive aids<sup>14</sup>. In over half the courses, an issue with the design, availability or maintenance of equipment was identified. Four out of five courses identified at least one area of weakness in staff knowledge or skills. Often these knowledge gaps related to one or more key team member identifying they would benefit from additional training, for example in defibrillator use, crisis checklists or CPR. Such identification provides hospitals with an opportunity to identify and address threats that may otherwise pose a threat to future patients.

### Realism

Psychological fidelity describes the extent to which participants engage in simulations as they would performing the same tasks in a clinical setting<sup>15</sup>. Within NetworkZ surgeons can respond to bleeding, sepsis or trauma how they normally would, cutting, resecting, suturing or controlling bleeding in anatomical models realistic enough to trigger these responses. Anaesthetists can administer real IV medications and anaesthetic gases, and monitor the "patient" as they normally would, and nurses can work with the same instruments, manage asepsis, access the usual surgical equipment and record blood loss, as they would with a living patient. This helps participants engage with the scenario, undertake real clinical tasks in real time, and interact with their team as if they were managing an actual patient.

NetworkZ's bespoke surgical models are integrated with a computerised Laerdal 3G SimMan manikin (Laerdal Medical). A blood pump simulates haemorrhage. Examples of the surgical models include a ruptured appendix, a traumatic leg amputation, and a neck mass compromising the airway. Moulage and custom-built face masks add to the creation of a convincing "patient". Scenarios have been developed for the surgical specialties of general surgery, otorhinolaryngology, urology, orthopaedics, and plastic surgery. Each simulated scenario includes critical events such as airway complications, haemorrhage or shock.

Figure 1. Full body manikins fitted with moulage and interactive surgical models

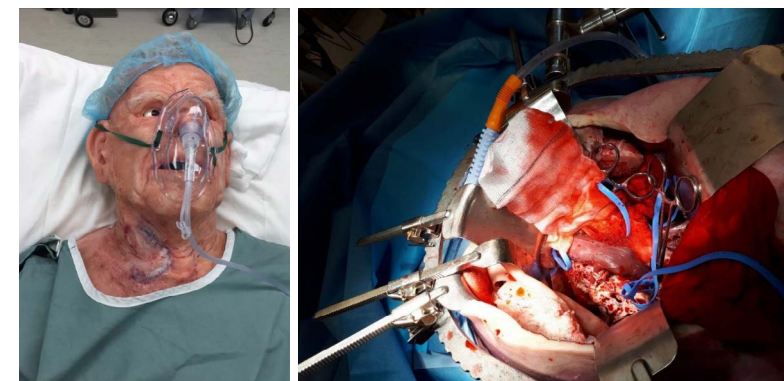

## NATIONAL ROLLOUT

NetworkZ had the ambitious goal of establishing team training as business as usual for operating theatre teams across New Zealand. The rollout to perioperative departments follows a stepped-wedge cluster-randomised study design<sup>15</sup>. Five to seven public hospitals were introduced to NetworkZ each year between 2017 and 2021.

The initial rollout was supported by an engagement strategy, a letter agreement with each hospital CEO to commit resources to the training in return for access to the program and a Laerdal 3G simulator. In all, 18 3G simulators were deployed around New Zealand. Each participating hospital established a local NetworkZ team to become trained as NetworkZ instructors and technicians, with support from the University of Auckland NetworkZ faculty. NetworkZ faculty visited each site to help local staff identify and manage risks associated with in-situ simulation and ensure a safe learning environment for participants. The faculty also work with staff from around NZ to develop new scenarios and models.

Each hospital has taken their own approach to program implementation and course frequency. Some hospitals have essentially “rostered” a team to in situ simulation training for the morning, others have utilised whole-of-theatre education afternoons to deliver the training.

Over the first four-and-a-half years of the perioperative program (2017 to June 2021), 2000 participants attended a course and 330 local staff began instructor training.

Ideally, such training needs to be repeated, regularly. Much as airline cockpit crews are required to undertake non-technical skills training at least once every two years<sup>16</sup>, there is a strong case that operating theatre teams participate in repeated simulation team training.

### Expansion into emergency department (ED) and post-anaesthetic care unit (PACU) settings

The establishment of simulation manikins and simulation expertise at each hospital has facilitated the development of similar programs in other departments. Concurrent programs of simulation have now been developed for ED and PACU settings, drawing on the popularity of the OR program. Similar to the NetworkZ course in operating theatres, the ED and PACU courses involve communication skills training, realistic in situ simulations followed by extensive team debriefing sessions.

Participants include all professions who work together in each setting. ED course participants may include paramedic, ICU specialists, anaesthetists, surgical specialists, ICU registrars, surgical registrars, nurses, orderlies, radiographers, and blood bank staff.

### Train-the-trainer model

A national program of this scale requires a “train the trainer” model, building capacity for local staff to deliver the program in their own hospitals.

Instructor training involves a two-day workshop, online modules and mentoring and feedback during delivery of initial courses. Instructors demonstrate competency in the Entrustable Professional Activities (EPAs) relevant to their role in NetworkZ in order to become an accredited NetworkZ instructor. The EPAs cover:

1. Effective teamwork fundamentals.
2. Safe learning environment.
3. Conduct a scenario.
4. Identify learning points for debriefing.
5. Conduct a debrief.
6. Evaluate teaching and learning.
7. Risk management.
8. Prepare the environment for simulation.
9. Operate the simulation equipment.
10. Maintain simulation resources.

Training local instructors may offer sustainable benefits beyond the delivery of simulation training by an external agency, including improved local capacity for addressing systems issues and for debriefing staff after real-life patient crises. Local staff can become experienced in setting up and running simulation events, opening the possibility for such training to become business as usual and to extend to similar training for other areas of the hospital. This hope has come to fruition, with application of NetworkZ principles to running safe, high quality simulations in other parts of the hospital, and movement of NetworkZ-trained instructors between hospital departments.

## EVALUATION

The New Zealand rollout of NetworkZ into perioperative settings is accompanied by a multi-faceted effectiveness evaluation that will examine whether NetworkZ achieves its aims of improving communication and teamwork skills in the operating theatre, and if so whether this translates to improvements in patient outcome. An earlier “efficacy” pilot indicates that the intervention delivered by expert instructors in simulation centres improves real-world communication and teamwork<sup>17</sup>.

The staged national roll-out of the NetworkZ program allows for a stepped-wedge cluster study design over a four-year time period. This design is an option for quality improvement designs, where random assignment at the level of the individual is not possible<sup>18</sup>.

The primary outcome measure for this evaluation is Days Alive and Out of Hospital at 90 days (DAOH<sub>90</sub>)<sup>19,20</sup>. DAOH<sub>90</sub> is an holistic measure of patient outcomes, where optimal care is assumed to lead to fewer days in hospital and lower mortality. This measure calculates how many days were spent alive and out of hospital over the 90 days following surgery. Any complication that increases length of stay or requires readmission within 90 days will reduce DAOH<sub>90</sub>. In NZ DAOH<sub>90</sub> can be calculated from a national database of routinely collected patient admission data. Risk adjustment can be undertaken to supplement the stepped wedge design in mitigating confounding factors. Rates of particular complications, and process measures of teamwork and communication will also be examined<sup>15</sup>. This is real world research, and the results will reflect the complexities of real-world implementation of a major quality improvement initiative.

Teamwork outcome measures include in theatre observations of teamwork, and surveys of teamwork perceptions and surgical safety culture. Interim analysis of these measures indicate small but significant improvements across measures. An analysis of more than 100 post-course reports found that potential patient safety threats are often identified during courses<sup>14</sup>. Identifying and addressing these threats is another way that the NetworkZ courses may contribute to improved patient safety.

Post-course feedback suggests near-universal support from participants: more than 98 per cent of staff who participated in a local NetworkZ course or NetworkZ instructor course report satisfaction with the quality of the course. Interviews with those involved in delivering or setting up the training suggest that there is a strong interest in maintaining this initiative in New Zealand<sup>21,22</sup>. Interviewees have also described improvements in teamwork and communication following the training, such as better sharing of information, greater awareness of each other's roles and less siloed teamwork<sup>21</sup>.

## RESOURCING AND SUSTAINABILITY

Initial development, oversight and rollout of NetworkZ to perioperative departments in New Zealand was funded by the country's national accident insurer, the Accident Compensation Corporation (ACC) as part of their prevention strategy for injury caused by treatment. This funding provided deployment of 3G simulators around the country, development of surgical models for the simulations (accessed through a central booking system), staffing to develop and run the program, and travel. Participating hospitals contributed by supporting staff to attend instructor training and in situ courses, admin time and on occasions, simulation technician time, and providing a theatre for in situ training, either instead of running a scheduled list or during half or full day education shut down days. The Health Quality and Safety Commission have contributed at the governance level and promoting the course through their website and communications.

Each local course requires a minimum of four local instructors or support staff to be available for the course duration (four hours) and at least an hour to set up and an hour to pack up. One instructor will also support course scheduling and share information with participants prior to the course.

Operating theatres (or other clinical environments) need to be released from routine clinical work from time to time for the training. The use of operating theatres represents an opportunity cost, which may manifest as a reduction in patients treated and (in some systems) as a direct loss of revenue.

However Jabbour and Snyderman<sup>23</sup> argue that hospital systems, malpractice insurance companies and health insurance companies may be appropriate funders of simulation as these bodies all have potential for cost savings<sup>23</sup>. Cost savings from reduced complications may be large. Dimick<sup>24</sup> estimated that a single major complication cost a hospital around \$US11,626.

### Future outlook for multidisciplinary training

We believe that this type of training should be business as usual for operating theatre staff and other acute healthcare teams, in the same way that simulation training is for airline pilots.

Typically, case reviews, departmental meetings and continuous professional development are all undertaken in professional silos. Embracing multi-professional training requires commitment from management to schedule time when multi-professional groups can get together other than in the direct care of patients. While the timetabling may be challenging, almost every public hospital in New Zealand has found a solution that enables staff from every role within the operating theatre to come together to participate in a NetworkZ course.

While each of the professional colleges (RACS, ANZCA, Nursing) has endorsed NetworkZ and participants may claim CME, without an overarching multi-professional body, implementing courses that span professional groups presents difficulties not encountered by the more traditional courses such as EMAC, Early Management of Severe Trauma (EMST) and the RACS course, Operating with Respect. Mandating some form of multi-professional team training for CPD either at a college level, or through the Medical Council, could provide a clearer pathway for courses such as NetworkZ.

## CONCLUSION

Simulation-based team training is not new, but the combination of three elements of NetworkZ; integrated surgical and anaesthesia simulator, in situ delivery and multidisciplinary participation are relatively novel. Initiatives such as NetworkZ can start the process of building expert teams from expert healthcare professionals, and thereby help to solve the problem of unintended harm to patients undergoing surgery.

## REFERENCES

- Jha AK, Larizgoitia I, Audera-Lopez C, Prasopa-Plaizier N, Waters H, Bates DW. The global burden of unsafe medical care: Analytic modelling of observational studies. *BMJ Qual Saf.* 2013; 22(10):809-15.
- Sunshine JE, Meo N, Kassebaum NJ, Collison ML, Mokdad AH, Naghavi M. Association of adverse effects of medical treatment with mortality in the united states: A secondary analysis of the global burden of diseases, injuries, and risk factors study. *JAMA Netw Open.* 2019; 2(1):e187041-e.
- Lingard L, Espin S, Whyte S, Regehr G, Baker GR, Reznick R, et al. Communication failures in the operating room: An observational classification of recurrent types and effects. *Qual Saf Health Care.* 2004; 13(5):330-4.
- Gawande AA, Zinner MJ, Studdert DM, Brennan TA. Analysis of errors reported by surgeons at three teaching hospitals. *Surgery.* 2003; 133(6):614-21.
- Mazzocco K, Petitti DB, Fong KT, Bonacum D, Brookey J, Graham S, et al. Surgical team behaviours and patient outcomes. *Am J Surg.* 2009; 197(5):678-85.
- Salas E, Sims DE, Burke CS. Is there a "big five" in teamwork? *Small Group Res.* 2005; 36(5):555-99.
- Weller J, Morris R, Watterson L, Garden A, Flanagan B, Robinson B, et al. Effective management of anaesthetic crises: Development and evaluation of a college-accredited simulation-based course for anaesthesia education in Australia and New Zealand. *Simul Healthc.* 2006; 1(4):209-14.
- Cumin D, Boyd MJ, Webster CS, Weller JM. A systematic review of simulation for multidisciplinary team training in operating rooms. *Simul Healthc.* 2013; 8(3):171-9.
- Neily J, Mills PD, Young-Xu Y, Carney BTC, West P, Berger DH, et al. Association between implementation of a medical team training program and surgical mortality. *JAMA.* 2010; 304(15):1693-700.
- Arriaga AF, Gawande AA, Raemer DB, Jones DB, Smink DS, Weinstock P, et al. Pilot testing of a model for insurer-driven, large-scale multicenter simulation training for operating room teams. *Ann Surg.* 2014; 259(3):403-10.
- Deering S, Rowland J. Obstetric emergency simulation. *Semin Perinatol* 2013;37(3):179-88.
- Patterson MD, Geis GL, Falcone RA, LeMaster T, Wears RL. In situ simulation: Detection of safety threats and teamwork training in a high risk emergency department. *BMJ Qual Saf.* 2013; 22(6):468-77.
- Sørensen JL, Østergaard D, LeBlanc V, Ottesen B, Konge L, Dieckmann P, et al. Design of simulation-based medical education and advantages and disadvantages of in situ simulation versus off-site simulation. *BMC Med Educ.* 2017; 17(1):20.
- Long JA, Webster CS, Holliday T, Torrie J, Weller JM. Latent safety threats and countermeasures in the operating theater: A national in situ simulation-based observational study. *Simul Healthc.* 2021; (Advance online publication).
- Weller JM, Long JA, Beaver P, Cumin D, Frampton C, Garden A, L, et al. Evaluation of the effect of multidisciplinary simulation-based team training on patients, staff and organisations: Protocol for a stepped-wedge cluster mixed methods study of a national, insurer-funded initiative for surgical teams in New Zealand public hospitals. *BMJ Open.* 2020; 10:e032997.
- Civil Aviation Authority of New Zealand. Ac121-4: The training and assessment of human factors and crew resource management 2013 (Wellington).
- Weller JM, Cumin D, Civil I, Torrie J, Garden A, MacCormick A, et al. Improved scores for observed teamwork in the clinical environment following a multidisciplinary operating room simulation intervention. *N Z Med J.* 2016; 129(1439).
- Webster CS. Evidence and efficacy: Time to think beyond the traditional randomised controlled trial in patient safety studies. *Br J Anaesth.* 2019; (122):723-5.
- Myles PS, Shulman MA, Heritier S, Wallace S, McLroy DR, McCluskey S, et al. Validation of days at home as an outcome measure after surgery: A prospective cohort study in Australia. *BMJ Open.* 2017; 7(8):e015828.
- Jerath A, Austin PC, Wijeyesundera DN. Days alive and out of hospital: Validation of a patient-centered outcome for perioperative medicine. *Anesthesiology.* 2019; 131 84-93.
- Long JA, Jowsey T, Henderson K, Merry AF, Weller JM. Sustaining multidisciplinary team training in New Zealand hospitals: A qualitative study of a national simulation-based initiative. *N Z Med J.* 2020; 133(1516):10-21.
- Jowsey T, Beaver P, Long J, Civil I, Garden A, Henderson K, et al. Towards a safer culture: Implementing multidisciplinary simulation-based team training in New Zealand operating theatres, a framework analysis. *BMJ Open.* 2019; (9):e027122.
- Jabbour N, Snyderman CH. The economics of surgical simulation. *Otolaryngol Clin North Am.* 2017; 50(5):1029-36.
- Dimick JB, Chen SL, Taheri PA, Henderson WG, Khuri SF, Campbell DA. Hospital costs associated with surgical complications: A report from the private-sector national surgical quality improvement program. *J Am Coll Surg.* 2004; 199(4):531-7.

## Teaching medical students during clinical anaesthesia placements

### Jeremy Rogers BSc, MD, MPH

**Emergency Department Registrar, Sir Charles Gairdner Hospital, Nedlands, WA**

Dr Jeremy Rogers is an emergency medicine trainee with a keen interest in critical care medicine. He regards research and evidence-based medicine as a vital cornerstone of modern medical practice, and has a passion for further improving medical education and the teaching provided in hospitals.

### Jeremy Carman BPhysio, MD

**Resident Medical Officer, Royal Perth Hospital, Perth, WA**

Dr Jeremy Carman is a junior medical officer with an interest in anaesthesia, paediatric and regional and remote medicine. His career aspirations were inspired by time spent in both Perth metropolitan hospitals and the Kimberley as a medical student.

### Andrew Gardner MB BS, PGDipEcho, FANZCA, AMusA, ARCO

**Department of Anaesthesia, Sir Charles Gairdner Hospital, Nedlands, WA**

Dr Andrew Gardner is a senior staff specialist anaesthetist with an interest in cardiothoracic and liver transplant anaesthesia, whose interest in anaesthesia as a career was fostered by an excellent placement and teaching in anaesthesia during his undergraduate medical degree. He is a past chair of the ANZCA primary examination.

### Ross MacPherson BPharm, MSc, DHP (Syd), BMed (Hons), PhD, FANZCA

**Department of Anaesthesia and Pain Management, Royal North Shore Hospital, St Leonards, NSW**

Dr Ross MacPherson is a senior staff specialist anaesthetist who until recently has overseen the anaesthesia teaching program at his hospital. He is also clinical professor at the Northern Clinical School, University of Sydney, and a past chair of the ANZCA primary examination.

## INTRODUCTION

The number of medical graduates from Australian and New Zealand universities has increased from approximately 1275 in 1992 to an expected number of 4138 in 2021. In addition to the establishment of new public university medical schools, there has also been the establishment of private university medical schools, such that there are now 23 universities across Australia and New Zealand producing medical graduates. There is a roughly equal split between undergraduate and graduate courses. The increased presence of medical students within private hospitals and the creation of rural clinical schools has seen medical students undertake clinical anaesthesia rotations outside of major metropolitan teaching hospitals. It is therefore extremely unlikely that any consultant anaesthetist or registrar, whether in public or private, or metropolitan or rural practice, will not be involved in the practical teaching of medical students within their workplace. Although this chapter may provide guides and ideas for established departments and individuals, it may be more relevant to those newly involved in medical student teaching. The general concepts are relevant to all departments where teaching occurs.

An anaesthesia placement is a relatively unique opportunity for medical students, where students often experience one-on-one clinical teaching from a consultant anaesthetist or registrar. These placements are not only an opportunity for students to learn anaesthesia, but also an opportunity to showcase anaesthesia as a specialty. It may be their only exposure to the specialty and encourage students to pursue it in the future. Interpersonal variables in the doctor-student relationship are not only important in promoting the specialty, but also account for a significant variability in the effectiveness of teaching. An effective clinical teacher has been described as a virtuous clinician; being knowledgeable, competent, caring and professional<sup>1</sup>. However, an effective clinical teacher also organises and adapts their teaching, provides mentoring and support, and adopts a supervisor and feedback role. Given the increasing exposure of most anaesthetists to the teaching environment, it is increasingly necessary for anaesthetists to have an understanding of basic educational principles.

Students express preference for teaching sessions that avoid didactic “lecture-style” teaching and instead prefer sessions where they are actively and practically involved. The “flipped classroom” approach to teaching is increasingly being adopted by medical curricula to promote adult learning principles and active learning strategies. In this approach, students are first exposed to educational content via readings, videos or other e-learning techniques before their knowledge is reinforced in the subsequent teaching session. Anaesthesia teaching is perfectly suited to a flipped classroom approach, where students receive their formal teaching first, and can then reinforce concepts in a one-on-one setting<sup>2</sup>.

In being exposed to anaesthesia as a medical specialty, it is important for medical students to realise that anaesthesia is more than a mere service provider. It is also intimately involved in perioperative care, with the potential to influence outcomes such as progression to chronic pain, and continues to make important contribution to improvements in safety and quality in healthcare.

## CHANGES IN MEDICAL SCHOOL ENTRY AND CURRICULUM

In Australia and New Zealand, not only is there a mix of undergraduate and graduate medical schools, there also exists a wide variety of entry pathways into medical schools. Similarly, there are differences in the curricula of the various medical schools. The days when a medical student on an anaesthesia placement could be confidently expected to have a significant and in-depth understanding of the basic sciences as applied to clinical medicine are in the past. For those in graduate medical schools, undergraduate degrees may range widely from a degree in biomedical science to degrees in law or music performance. In the pre-clinical years of medical degrees, areas that were previously taught in detail to all medical students may now only be further developed in elective units, such as detailed anatomy or pharmacology. This is important for clinical teachers in having appropriate expectations of previously acquired knowledge before clinical rotations.

## REALISTIC EXPECTATIONS OF TEACHING GOALS FOR A CLINICAL PLACEMENT IN ANAESTHESIA

The competing interests of multiple clinical subject areas of current medical courses precludes overly detailed or excessively broad teaching of anaesthesia. Anaesthesia placements for medical students are necessarily shorter than other medical disciplines. Short clinical placements necessitate learning outcomes that are clear, concisely defined, and relevant. Not unsurprisingly, anaesthetists and students may have different expectations regarding the outcomes of their clinical placements.

It is important that anaesthetists have realistic expectations of the skills and knowledge in which a student will be required to have demonstrated competency at the end of a placement. At the end of a six-week general surgical placement, it would not be expected that a medical student would be able to perform an appendicectomy; similarly, at the end of a cardiology term to manage a patient with complex valvular heart disease. It is therefore unrealistic to expect that at the end of a short anaesthesia placement, a medical student should be able to give an unsupervised anaesthetic and have detailed knowledge of anaesthetic pharmacology. Regardless of the long-term career aspirations of medical students, as junior doctors they will all be required to manage patients undergoing procedures perioperatively, manage acute pain and nausea and vomiting, and respond to rapidly deteriorating patients on the ward. A clinical placement in anaesthesia not only provides the opportunity to discuss the physiology and pharmacology of anaesthesia and the teaching of certain skills relating to airway management and cannulation, but also the investigation and management of perioperative patients generally.

Hopefully, the expectations of students for the goals and expected teaching in an anaesthesia term would generally align with the expectations of anaesthetists. Many students comment that anaesthetists not only have specific anaesthesia knowledge, but also an excellent working knowledge of the broader areas of medicine, surgery and pharmacology that interact with their daily work – an often-untapped source of good clinical information. Students on an anaesthesia placement can expect to gain exposure to both airway management and vascular access, but also comprehensive perioperative management and often simulation teaching.

Medical students want teaching provided to them that does not oversimplify or condescend, but also teaching that does not expect inappropriately advanced knowledge<sup>1</sup>. Many students undertaking critical care rotations are also generally in the more senior years of their course and will appreciate practical approaches to managing acute pain and other perioperative issues for their future work. However, this may not always be the case and it is critical that departmental staff appreciate where the anaesthesia rotation is placed within the degree course. The other expectation from medical students is ensuring examination readiness.

University learning guidelines for medical students have definitive broad learning objectives. These may contain more specific topics. Within a short anaesthesia placement, it is important to ensure adequate practical experience, whilst still imparting important theoretical knowledge. Often the breadth of these learning outlines is impossible to cover within the short time span of an anaesthesia placement, and requires the student to independently seek further knowledge through self-directed learning.

## FACILITATING TEACHING AND LEARNING AT A DEPARTMENTAL LEVEL

Each hospital has a different clinical load and organisational structure. There are relatively few academic anaesthetists employed by university departments, and many placements will be undertaken in departments without a formal university presence. Although these suggestions may be more suitable for a larger hospital department than a smaller or rural hospital, they provide the basic organisational structure to enable successful teaching within the clinical placement. Some of these suggestions are simple, but essential:

1. There needs to be a designated staff member to facilitate the rotation and be a contact point for students. Similarly, there needs to be an identified contact within the university who is available for clinical teachers to discuss rotations and students.
2. It is important to make sure that the students feel part of a team. Advanced rostering to theatre lists and notification of this ensures that not only the students are aware of what is expected of them, it also gives early notice to the clinician that they will be having a student. On the day allocation to lists may occasionally be necessitated by clinical circumstances, but it is likely to lead to a less fulfilling theatre list for both the teacher and the student, and is likely to give an unfavourable impression of anaesthetists' commitment to medical students and teaching. Simple things such as ensuring that students have access to library spaces, locker access in change rooms, and wi-fi passwords also encourages them to feel part of a team, and not a burden.
3. An anaesthesia rotation should involve more than just spending time in the operating theatre. It is important that students are aware of the many roles that anaesthetists play within the hospital. If it is discovered that a student has only spent time in theatre, consideration should be given to arranging other clinical experience such as attendance at a pre-admission clinic, acute pain service rounds, or a session at a chronic pain clinic. If the hospital clinical practice includes obstetric and paediatric anaesthesia services, these should be made available to students if feasible.
4. Although they may go by various names and be either physical or electronic, students should have a workbook or handbook from their medical school outlining the learning outcomes and expected clinical skills to be learned during their anaesthesia rotation. These should be available to all clinical teachers, and copies readily available in departmental libraries (see note at the end of this chapter). Prior knowledge of what is expected from a rotation removes pressure from both the clinical teacher and the student.
5. Enabling timely feedback to students is important in both identifying and remediating poorly performing students. In addition, encouraging student feedback provides clinicians (and the broader teaching/ anaesthesia department) an opportunity for quality improvement, and a means of improving teaching and the overall usefulness of the term to students.

## TEACHING ACTIVITIES

Individual anaesthetists have a wide range of different clinical practices with differing expertise and skills in both clinical and non-clinical aspects of anaesthesia. The areas listed below of possible teaching topics is extensive, and it is not expected that each individual anaesthetist will necessarily be familiar with all areas and can teach these topics. However, the list provides ideas about teaching which anaesthetists may wish to consider utilising with their students. Some of them are basic, but it may be the only opportunity that a student receives clinical exposure in that area.

### Core practical clinical skills

1. Airway and ventilation skills

Although students may receive teaching in airways skills in other placements, the nature of an anaesthesia placement allows for consolidation of these skills. With the introduction of supraglottic airways into the management of emergency and resuscitation situations, the days when successful placement of an endotracheal tube was considered the goal of an anaesthesia placement have been superseded by prioritising a different set of clinical proficiencies. More important to a junior doctor are the tasks of bag/mask ventilation, the placement of supraglottic airways, and the recognition of the obstructed airway and identification of failure to ventilate. In particular, teaching these skills and concepts in the clinical context of their use in advance life care algorithms will further reinforce this learning. This will be directly translatable for junior doctors in clinical scenarios such as responding to clinical deterioration on the wards or working in emergency medicine.

## 2. Intravenous cannulation

Often this is a major focus for medical students, and anaesthesia placements provide an ideal opportunity for the placement of peripheral inserted intravenous cannulas in a controlled learning environment. Perioperative cannula placement allows students to refine their technique, with direct access to experienced clinicians guiding them. However, it should be emphasised to the student that while this skill is important to a junior doctor, it should not be prioritised to the exclusion of other teaching opportunities which may be restricted on an anaesthesia rotation. Students will have opportunities to insert cannulae in future placements due to the universal need for intravenous access in the hospital setting.

## 3. Basic ultrasound skills

The role of ultrasound is ever increasing in clinical medicine, and ultrasound machines are frequently used not only in the operating theatre, but often in emergency and ward patient management. While it is unreasonable to expect medical students to have the anatomical knowledge and technique to perform nerve blocks, it is not unreasonable to teach basic ultrasound skills. With the proviso of patient consent, such basic skills such as the identification of veins in patients with difficult venous access, identification of arteries, identification of normal lung markings and identification of air and fluid within the chest cavity may be taught.

## 4. Oxygen delivery systems.

Many medical students are surprised to find that oxygen is a drug which requires a prescription. Theatre placement provides an ideal situation for the benefits, limitations and contraindications to different modes of oxygen delivery including low and high flow nasal prongs, re-breathing and non re-breathing masks to be discussed while allowing the student to place the device.

## 5. Principles of monitoring

While pulse oximetry has long been a mainstay of ward patient assessment, the increasing use of capnography in the setting of ward medical emergency management has necessitated teaching in this area. The anaesthesia rotation allows for thorough discussion and teaching of the use, benefits and limitations of these monitors.

### Practical perioperative patient management

#### 1. Perioperative medicine

With increasing frequency, patients are admitted on the day of elective surgery and many patients are not reviewed by anaesthetists before hospital admission. Thus, there is an increasing need for junior doctors to be aware of perioperative issues that may be of concern to anaesthetists. It is not necessary for students to have a detailed understanding of the management of complicated medical conditions and treatments, but it is important that they are able to identify areas that have clinical significance for anaesthetists and know to seek further advice regarding the management of these areas. Examples of topics for discussion may include the management of anticoagulation in patients with atrial fibrillation or mechanical valve replacement, the management of type 1 and type 2 diabetic medications, and the complexities of chronic pain.

#### 2. Acute pain management and the management of nausea and vomiting

Depending on the clinical school curriculum and the timing of the anaesthesia rotation, there is likely to be a wide variety in the depth of pharmacological knowledge related to these topics before the rotation. The operating theatre setting provides not only the opportunity for students to learn or reinforce the pharmacology of these drugs, but also to see the action of the drugs clinically.

#### 3. Intravenous fluids

Despite being a core skill in clinical practice, the prescription of intravenous fluids is often taught in a haphazard fashion within various medical disciplines. The anaesthesia term allows for consolidated teaching on this topic.

#### 4. Recognising and responding to the deteriorating patient

The Australian Commission on Safety and Quality in Health Care has instituted a standard entitled *Recognising and Responding to Acute Deterioration*<sup>3</sup>. This has been developed in response to the increasing evidence of the importance of recognising clinical deterioration and initiating responses to prevent serious patient morbidity and mortality. Topics for discussion could include normal values for vital signs and normal examination findings, expected intraoperative and postoperative changes, and the perioperative factors that may influence changes in vital signs and examination findings.

### Non-technical skills

#### 1. Principles of human factors and patient safety

As a medical specialty, anaesthesia has been at the forefront of improving patient safety and outcomes. Numerous reports have identified human factors as being responsible for near misses and adverse outcomes in anaesthesia<sup>3</sup>. The principles by which anaesthetists undertake safety and quality reporting, such as reporting of critical incidents, clinical indicators for anaesthesia, and WebAIRS can be explained and further developed in the theatre setting. Similarly, discussion of the use of protocols in anaesthesia crises such as anaphylaxis and suspected malignant hyperthermia, and the use of simulation in managing anaesthesia crises allows medical students to understand methods for reducing the influence of human factors. Permitting students to lead the "Team Time Out" not only allows them to become involved with protocols for improving patient safety, but also engages them regarding the use of deep venous thrombosis and antibiotic prophylaxis.

#### 2. Teamwork and communication

Despite these being core clinical skills, students generally have few opportunities to see healthcare teams in action. This is multi factorial, with fewer rotations being conducted within tertiary hospitals where multidisciplinary patient care is more common, and increasing external commitments reducing time spent with direct patient contact. In addition, surgical patients may be managed at different sites to where the treatment regimen was planned. This placement allows students to understand the concept of shared care, not only between the anaesthetists and other medical practitioners such as surgeons and intensive care physicians, but also between the members of multidisciplinary teams in the theatre setting, including medical staff, nursing staff, anaesthesia assistants, and orderlies. Watching handover processes between anaesthesia and recovery staff as the patient passes from one part of the theatre complex to another, and encouraging students to participate in handovers, can be particularly instructive in terms of demonstrating the process of continuity of care. Students should be made aware of the importance of both clear communication and the delineation of roles in the safe management of the anaesthetised patient.

### RESOURCES FOR INDIVIDUAL ANAESTHETISTS TO INCREASE AND IMPROVE TEACHING SKILL

For many anaesthetists who are not regularly involved in teaching, the idea of having to teach may be daunting. For those who wish to improve their teaching abilities, there are several resources available:

#### 1. General teaching resources

Since 2000, the delivery of *Teaching on the Run* courses has become widespread in Australia and New Zealand. This course provides strong foundations for clinical teaching in the operating theatre. Commencing in April 2004, the *Medical Journal of Australia* published a series of articles based on this course, and the complete set is available for purchase as a book<sup>1,5</sup>.

#### 2. Teaching courses

In addition to *Teaching on the Run* courses, ANZCA has developed the ANZCA Educators Program which offers different modules which range from planning effective teaching and learning to the use of technology in teaching and learning. Although developed primarily for the teaching of anaesthesia trainees, the modules are also relevant to teaching medical students.

#### 3. Prepare a teaching portfolio

Prepared either paper-based or electronically, a portfolio containing interesting ECGs, ABGs, airway CT scans, and other investigations, as well as thought-provoking clinical scenarios, provides opportunities for discussion and learning. These can be best utilised in the absence of discussion points with the patient being managed in theatre. A wide variety of investigations and images are easily found on the internet.

Clinical scenarios provide an opportunity for learning during long cases. The scenarios do not need to be complicated – even the simplest scenarios provide opportunity for discussion and learning. Not only do clinical scenarios allow for teaching and preparedness for clinical practice, their format and interaction with the anaesthetist mimic many assessment formats enabling exam preparedness. Examples of clinical scenarios are given in the box below.

## CONCLUSION

Many clinicians will remember the outstanding teachers of their clinical years in medical school, some of whom may have been the inspiration to choose current career paths. While not every clinician finds clinical teaching easy, it is important that medical students undergoing their anaesthesia rotation are able to complete the learning outcomes within the speciality such that they will be safe junior doctors in the future and be inspired to undertake further self-motivated learning.

It is important to realise that not every theatre list will be an ideal opportunity for teaching. A list with a particularly complicated patient having a high expected perioperative mortality, or those patients in whom unexpected complications occur, are such examples. We believe that students will still learn by watching the management of these complicated clinical situations. A simple communication explaining that there may be limited formal teaching but still much to learn may be appreciated by the student, and likely to maintain their interest.

One ANZCA competency in the current training program is that of scholar, and within that competency the role in practice of being able to teach others. For those who have been awarded the FANZCA diploma in recent times, assessment of this competency will have occurred throughout training. For those who are obtaining specialist recognition before this time, the skills of education may have been less thoroughly taught and assessed. We hope that this brief chapter may provide some resources for those who continue to find teaching daunting.

*(Note: Ross MacPherson is happy to provide a copy of the anaesthesia workbook used by medical students at The University of Sydney, which can be used as a template for your own. He can be contacted at ross.macpherson@health.nsw.gov.au).*

### Examples of clinical scenarios

A 65-year-old man with a previous mechanical valve replacement on warfarin presents for a colectomy. How would you manage his anticoagulation perioperatively?

The ward contacts you regarding a 24-year-old female patient who has had a laparoscopic appendicectomy, and is continuing to vomit. How would you manage this patient?

A 52-year-old female presents for laparoscopic procedure for a malignant gynaecological condition which is expected to last for four hours. What risk factors may predispose this patient to developing a deep venous thrombosis? What are the strategies used to reduce the incidence of deep venous thrombosis in the perioperative period?

You are the junior medical officer in the preadmission clinic and clerking a patient in preparation for a left hemicolectomy. The patient is a type 2 diabetic on metformin, empagliflozin, and insulin glargine. What arrangements would you make for this patient perioperatively?

You are the junior medical officer in the preadmission clinic and clerking a patient in preparation for a shoulder arthroscopy as a day case who will meet the anaesthetist on the day of surgery. The patient is a type 1 diabetic on a short acting insulin three times daily, and a longer acting insulin in the evening. How would you manage this patient's diabetic medications?

A 45-year-old patient has returned to the ward 12 hours ago after undergoing a laparoscopic cholecystectomy. You are called to review the patient because the patient is complaining of severe pain despite oral oxycodone. How would you manage this situation?

You are asked to review a 72-year-old six hours after a revision hip replacement. He has a history of ischaemic heart disease and takes ramipril and metoprolol. His pulse rate is 56 beat per minute, and blood pressure 95/65 mmHg. His preoperative blood pressure was 140/80 mmHg. How would you assess and manage this patient?

## REFERENCES

1. Lake FR. Teaching on the run tips: doctors as teachers. *Med J Aust.* 2004;180(8):415-6.
2. Ramnanan CJ, Pound LD. Advances in medical education and practice: student perceptions of the flipped classroom. *Adv Med Educ Pract.* 2017;8:63-73.
3. The National Safety and Quality Health Service Standards: Recognising and Responding to Acute Deterioration Standard. Sydney: Australian Commission on Safety and Quality in Health Care; 2017 [cited 15 April 2021] Available from: <https://www.safetyandquality.gov.au/standards/nsqhs-standards/recognising-and-responding-acute-deterioration-standard>
4. Jones CPL, Fawker-Corbett J, Groom P, Morton B, Lister C, Mercer SJ. Human factors in preventing complications in anaesthesia: a systematic review. *Anaesthesia.* 2018;73 Suppl 1:12-24
5. Lake FR, Ryan G. Teaching on the run: teaching tips for clinicians. Strawberry Hills (NSW): Australasian Medical Publishing Company Proprietary Limited; 2006.





# Management and legal

## **Clinical leadership in uncertain times**

Nicole Sheridan, Candida Marane

---

## **Realising the potential of anaesthesia technicians: The Royal Perth Hospital experience**

Peter Mulrooney, Laura Prates Vitoria

---

## **Socrates, Plato and the healthcare worker's duty to serve**

Elizabeth Hessian, Julian Savulescu

---

## **Medicolegal insights into anaesthesia**

Chris Bolton

---

## **Media moments for anaesthetists**

Simon Hendel, Jonathan (Joff) Lacey

---

## Clinical leadership in uncertain times

### Dr Nicole Sheridan, MBBS, FANZCA, MMed

Deputy Director, Department of Anaesthesia Pain and Perioperative Medicine, Western Health, Footscray, Victoria, Australia

Dr Sheridan has an interest in obstetric anaesthesia and sustainability. She assisted with developing operating theatre flows and processes during Melbourne's COVID-19 outbreaks.

### Dr Candida Marane, BSc, MBBS, Grad Cert Clin Ed, FANZCA

Head of Simulation and Emergency Response Training, Acting Deputy Director, Department of Anaesthesia Pain and Perioperative Medicine, Western Health, Footscray, Victoria, Australia

Dr Marane has an interest in medical education, simulation and multidisciplinary team training. She assisted with Western Health's response to Melbourne's COVID-19 outbreaks in multiple areas including education, training and the development of a Critical Care Outreach Team.

## INTRODUCTION

The COVID-19 pandemic has caused unprecedented disruption to our work and lives where constant ongoing and unpredictable change has become the new normal. There have been recent unimaginable shifts in the ways we live our lives and function within our workplace. Increasingly the robustness of the healthcare system is related to the health of our workforce and, more broadly, that of society and the planet.

The term "VUCA" is used widely in business and organisation management to describe conditions that are characterised by volatility, uncertainty, complexity, and ambiguity<sup>1</sup>. Prior to the COVID-19 pandemic, healthcare systems were becoming an increasingly VUCA world with the convergence of several factors. Increasing costs, economic concerns, growth and aging of population all presenting imperatives to find answers to sustain our system. The expectations of patients and families are continually evolving with increasing consumer expectations and the democratisation of medicine. Innovations, new technologies and advanced analytics are also being developed at an exponential rate. At local levels in the face of external factors, departments are facing challenges around mental health of doctors, training and work environments, workplace culture, co-ordination, and data and information.

Western Health is a large health service comprising three acute public hospitals and serving a community of approximately 800,000 people in the western region of Melbourne, Australia. Western Health was in a unique position during 2020. Two of Western Health's campuses, Footscray and Sunshine hospitals, were surrounded by the COVID-19 hotspots of metropolitan Melbourne in 2020. Western Health cared for more than 400 COVID-19 positive patients<sup>2</sup>. This is significantly more than most Australian hospitals, but thankfully is nowhere near the numbers seen by our colleagues overseas. As well as caring for COVID-19 positive patients many of our staff also lived in these COVID-19 hotspots.

Subsequent challenges that have faced us since the beginning of 2020 have included occupational health and safety and wellbeing of staff, trauma and burnout, urgency driven delivery services, shortages of equipment and drugs for delivery of care, teams fractured in to remote and virtual groups and rapid evolution of technology and digitalisation. We have been forced to adapt quickly and identify creative ways to operate. This has required a distinct set of leadership skills.

## WHAT IS CLINICAL LEADERSHIP?

Leadership is both the position or fact of being the leader and a set of characteristics that make a good leader<sup>3</sup>. Clinical leadership is a process of influencing point-of-care innovation and improvement in both organisational processes and individual care practices to achieve quality and safety of care outcomes<sup>4</sup>. As anaesthetists, we are well trained in the principles of crisis resource management (CRM). CRM has its origins in the aviation industry where it was found that human error contributed to more than 70 per cent of aviation accidents<sup>5</sup>. The majority of these errors were related to teamwork failures. Anaesthesia was the first healthcare speciality to adopt CRM. In the 1980s it was recognised that there were sufficient parallels between the work of anaesthetists and airline pilots to justify the adoption of aviation's Crew Resource Management principles<sup>6</sup>. CRM can be summarised as principles of individual and team behaviour in ordinary and crisis situations that focuses on skills of dynamic decision-making, interpersonal behaviour, and team management. Evidence shows training in CRM improves performance and reduces errors<sup>7</sup> and it is a fundamental component of the Australian and New Zealand College of Anaesthetist's (ANZCA) training program and continuing professional development. CRM is a key component of simulation training within our department for anaesthesia consultants, trainees and nurses.

## LEADING IN TIMES OF CRISIS

In medicine a crisis usually refers to a situation that requires multiple issues to be addressed simultaneously, has a time pressure in which these issues must be addressed and has a catastrophic outcome if the issues are not addressed<sup>8</sup>. These elements are all present in the COVID-19 pandemic and it would be appropriate to refer to it as a crisis. CRM is a key component of our clinical work, but it therefore also provides sound principles on which to base leadership during uncertain times such as a global pandemic.

Effective leadership in current disruptive environments needs to utilise a range of different styles. Increasingly, the term multimodal leadership is being coined. This term refers to instituting leadership at an individual, team, and organisational level. These roles have been described as a conductor, coach and champion<sup>9</sup>. While the CRM model serves us well, it does not address other aspects of managing a crisis including workplace culture, team and individual resilience, and individual wellbeing. The multimodal leadership model recognises the value of tiered leadership addressing the needs of individual team members, the team, and health service. Adapting and applying the core principles of CRM at the departmental level, utilising multimodal leadership styles, helped our team remain agile and provided a road map for navigating the chaos caused by the pandemic.

**Table 1. Multimodal leadership<sup>9</sup>**

Leadership level	Descriptor	Role in leadership
<b>Individual</b>	<b>Coach</b> Focusing on helping individuals achieve full potential while building trust and focusing on their wellbeing and professional development.	Aligning individuals interests and strengths with requirements of the department. Recognising successes. Ensuring mutual monitoring.
<b>Team</b>	<b>Conductor</b> Ensures that plans, decisions, information, and accomplishments are shared to coordinate and motivate team members.  Stimulate collaboration, creativity and innovation, creates a shared positive culture.	Creating shared leadership and goals. Designating and ensuring role clarity. Facilitating participative decision making. Creating resilient work models. Ensuring culture of psychological safety.
<b>Organisation/External</b>	<b>Champion</b> Allocate and secure team resources, tap into essential information sources, build trust with peers and other key stakeholders both in person and virtually.	Advocating for your team and managing resources. Providing positive role modelling, acting with integrity.

## PROVIDE EFFECTIVE LEADERSHIP AND ENSURE ROLE CLARITY

The CRM model requires effective leaders to designate leadership roles and maintain role clarity. Clinical leaders should ensure that the team has a shared mental model understanding what the team is working towards. A shared mental model is a team's shared, accurate, and complementary understanding of their purview, which enables teams to adapt and co-ordinate together. This can be accomplished through regular huddles and debriefings where roles and priorities can be clarified, and it can be determined who has the most expertise to take on a given need.

Shared leadership is encouraged by many organisations and is proven as an approach to meet increased complexity, such as that faced during the pandemic. Shared leadership is associated with improved team performance<sup>10,11</sup> and is most effective when done in a planned manner. It is imperative to avoid duplication and confusion so leaders must trust each other, have a common vision of goals and communicate effectively. With the shared leadership model there can still be one single person with ultimate responsibility, but leadership tasks can be shared. Encouraging participative decision making creates a culture where team members feel valued and have a sense of ownership regarding decisions that can ultimately affect their safety and wellbeing while at work.

During the COVID-19 pandemic some of the biggest challenges that we faced were related to the rapidly changing environment and changing directives from the government and organisation. This required dynamic situational awareness. To manage this challenge, we expanded the leadership roles within our department in a shared leadership model. We organised designated leaders to manage the most dynamic needs. Some of these areas included critical care outreach services, personal protective equipment (PPE), theatre workflows, equipment, rostering and telehealth. These leaders communicated frequently using video conference to integrate work and create a global situational awareness. This is an innovation that we have continued to remain connected on a daily basis and overcome some of the challenges created by our multicampus model.

Positive leadership results in teams possessing a belief that their team can succeed in current conditions, improving team performance. Positive leadership can be achieved by recognising the successes of the team which indicates signs of progress. Equally, recognising obstacles overcome and upcoming obstacles helps the team retain a sense of efficacy<sup>12</sup>. Within our department and organisation, during the COVID-19 pandemic, successes and barriers were recognised both formally and informally at many levels. Daily check ins with team members provided opportunities to acknowledge progress and hurdles. This enabled positive reinforcement of progress and problem solving as a team. The organisation commonly recognised achievements through electronic updates, video conferences, awards and use of social media.

## KNOW YOUR ENVIRONMENT

Knowing your environment helps maintain situational awareness, understand internal and external capabilities, and recognise strengths and vulnerabilities of the team and the surrounding environment.

Leaders need to monitor and understand both the internal and external environment, particularly in times of uncertainty. Sharing information with colleagues within your health network and externally, locally and internationally, using modern technological aids (videoconferencing, group information sharing apps) can assist in monitoring and gathering up-to-date information. We found this particularly useful with the rapidly changing environments and accelerated learnings during the COVID-19 pandemic.

To be able to adapt in times of change it is key to understand the internal capabilities of your team and recognising opportunities within the team to develop team members and coach them. Clinical leaders need to recognise where they can mobilise further resources as required. The redundancy created by cancelling elective surgery allowed us to create more resilient roster processes. We increased staff availability after hours to support the increased demands and cognitive load, we had staff allocated to cover sick leave and furloughed staff and created critical care outreach services to support surges in other departments.

Pre-existing relationships within the organisation and health service were crucial to our response during the pandemic. They allowed us to collectively recognise strengths and vulnerabilities across the organisation. The pandemic provided an opportunity to build on and improve these relationships, particularly with other critical care areas that we worked closely with in our organisation. Knowing the strengths and functioning of these departments allowed us to work together to provide dynamic solutions.

## COMMUNICATE EFFECTIVELY

Effective communication is essential for a resilient workplace. Communication of directives has been shown to be the number one organisational protective factor preventing symptoms of mental distress during the coronavirus outbreaks in healthcare staff<sup>13</sup>. As people struggle with evolving uncertainty, they will seek out information and analysis.

Good communication is required for a team to sustain a shared mental model, or in other terms, a shared cognition. This is an understanding of how the team will work together to safely accomplish their goals. The more overlap between individual mental models the greater the likelihood that team members will predict, adapt and co-ordinate with another successfully, even under stressful and novel conditions.

Communication needs to be regular, while recognising that time is often limited. It can be in the form of team huddles, handovers and pre-briefs and debriefs. These communications should cover current priorities, individual and team responsibilities and relay new and important information. As leaders we facilitated advocacy and allowed colleagues to ask questions and raise concerns. This must be encouraged so there is no fear or reluctance to speak up. We promoted a shared perspective because often when one team member has a query, others will also have the same query. The ability for team members to communicate feedback and questions was vital and allowed us to continue to tailor our response.

With rapidly evolving environments we have become better at communicating virtually through the use of video calling and conferencing. Recognising which tasks are better done in person and which can be done virtually is

important. Co-ordination of a team can often be done virtually, for example establishing goals, monitoring progress, information sharing and keeping colleagues connected. Tasks that involve collaboration are better done in a face-to-face environment for example fostering deep learning (simulation training, PPE training) and developing team culture. Virtual touch points were incredibly useful during the changing environment of the pandemic. We utilised them to check in daily, monitor resources, share information and create a team connection.

## ANTICIPATE, SHARE AND REVIEW YOUR PLAN

Through periods of rapid change, it is important to have a strong sense of mission and purpose directed by organisational and individual guiding principles. This provides stability and our core values can guide us towards clear decisions even in the face of uncertainty and ambiguity. For example, the mission and purpose may be providing the most appropriate and best possible care to your patients and to support your colleagues and ensure their wellbeing. Guiding principles might include being accessible, supportive and proactive, and willing to listen while being flexible and adaptable. In times of uncertainty, we gravitate to those whose purpose reflects our own personal values and beliefs.

Organisational culture is best described as the “way we do things here”. Where individuals or groups’ personal values and beliefs differ from the organisational culture, this can lead to lack of engagement and burnout. This can certainly be very challenging, particularly when individuals are concerned with personal or patient safety which they may see as not aligning with an organisation’s responses. Leaders need to listen to their team and acknowledge these differences and use them as an opportunity for deeper understanding and creativity finding areas of overlap between personal/group and organisation values and opportunities to align these guided by an overarching purpose. Leaders are required to be an intermediary between the organisation and individual team members, acknowledging concerns, providing background and honest responses and empowering individuals by including them in planning and decision making.

While it is important to share and review your plan, it is equally important that planning is a participatory process. Creating an environment where colleagues are able to speak up and contribute ideas and concerns in a respectful culture allows individual empowerment. It has been shown to be protective to the psychological health of the team and support collaborative problem solving<sup>13</sup>. We allocated senior and junior medical staff into teams to manage the areas mentioned above, reporting back to that area’s particular leader. This allowed team members to participate in decision making regarding their own workplace and safety. We know that team members actively taking part in making decisions and by determining the results of decisions, gain a sense of control of their lives during rapidly changing environments, particularly when there is a threat to one’s own wellbeing<sup>11</sup>.

Anticipating and planning for all contingencies was an important element of our response. Planning for the worst allowed team members to utilise all available resources in developing strategies and ensuring they were implemented and communicated to staff in advance of being required.

As leaders we represented our department to our organisation’s executive and external groups. In representing the entire group, it was essential that we displayed integrity and appropriate standards. We advocated for our department, colleagues and patients.

## DISTRIBUTE THE WORKLOAD – MONITOR AND SUPPORT TEAM MEMBERS

Given the rapid and evolving nature of the pandemic it was essential to our response to ensure the workload was distributed among our members. This allowed for efficient and effective solutions as new problems arose. It also meant we could harness the particular strengths that different team members possess. We ensured we had senior medical staff, junior medical staff and perioperative nurses working together to provide their different perspectives and skill sets.

During a crisis and uncertain times, it is imperative for a leader to ensure continued psychological safety of team members and colleagues. Psychological safety within a team is one of the strongest predictors of team effectiveness, and people need to feel safe and supported to be productive. It is the degree to which team members perceive that they can take interpersonal risks such as speaking up, admitting a mistake, acknowledging confusion, and offering a dissenting opinion without undue risk of being punished or rejected<sup>4</sup>. Psychological safety can be attained by having a culture of mutual respect for all team members, role modelling and inclusive behaviours. These have been shown to create an environment of trust.

As a department, we promoted psychological safety by empowering team members to speak up, lead within their own areas and independently make decisions when required. Firstly, we provided regular platforms where staff were encouraged to ask questions and voice concerns. This united us and often produced group decision making and solutions to complex problems. Secondly, we encouraged anaesthetists in theatre to make logistical

and safety decisions regarding the theatre team and patient. Our anaesthetists were aware that they were supported by the leadership team and that we were accessible at any time to be contacted.

Mutual team monitoring (MTM) is where individuals monitor the welfare of other team members. In times of crisis, it is inevitable that one’s attention is narrowed to that of their own job and wellbeing. MTM creates an effective team that can monitor the situation itself, team performance, and each of the teammates<sup>13</sup>. In our department, we created a “buddy system”, this was an extension of our existing mentor system. It necessitated more frequent communication between peers and the objective was to assess mood and provide support. Being paired with peers facing similar challenges and often similar feelings and reactions allowed for more open discussion. Paired team members would check in with each other several times a week, scoring how they felt from one (worst day at work, no desire to come to work) to 10 (best day at work, excited to come to work). This allowed opportunities to self-reflect, provide support, and debrief. Each member of the department was aware of additional supports for themselves and their “buddy” if required and the leadership group was always accessible when there were concerns regarding welfare of department members. This was vitally important as a department because we had lost our shared staff spaces where we would typically connect, share stories and create solidarity. We also found other ways of coming together, including lunchtime quizzes via videoconference, an online quiz night and producing a dance video.

As leaders we shared our vulnerability and showed empathy. We acknowledged that we too were affected by fear, the uncertainty and the unprecedented situation. Sharing struggles is not a sign of weakness but a powerful way to build trust. We acknowledged that leaders could make mistakes, and that there is no room for ego when leading a team. It is important to learn from mistakes and move on. Honest communication creates credibility.

## CONCLUSION

While there was no specific script for an event of this scale, our departmental leadership team created an organisational framework drawing from core CRM skills utilising multimodal styles. This served our department, organisation and patients well. While our responses were not always perfect, we adapted and learned. In the continuing pandemic environment and aftermath of the increased burden of patient and staff infections, reflecting on what we did well and carrying learnings forward has helped our department heal and continue to function in the current day stresses of an ongoing global pandemic, continuing with large projects and providing catch up surgery for our patients.

## REFERENCES

- Bennett N, Lemoine J. What VUCA really means for you. Harvard business review [Internet]. 2014 Jan [cited 2021 March 15]. Available from: <https://hbr.org/2014/01/what-vuca-really-means-for-you>
- Western Health Foundation. A Focus on Western Health’s ICU Response during COVID-19 webinar [Internet]. Melbourne: Western Health; 2020 [cited 2021 April 20]. Available from: <https://www.youtube.com/watch?v=nKrp46gTXLQ>
- Cambridge University. Cambridge Online Dictionary 2019 [Internet]. Cambridge (UK); 2019 [cited 2021 April 20]. Available from: <https://dictionary.cambridge.org/dictionary/>
- Australian College of Nurses. Nurse Leadership [Internet]. Canberra (ACT); 2017 [cited 2021 March 25]. Available from: [https://www.acn.edu.au/wp-content/uploads/2017/10/acn\\_nurse\\_leadership\\_white\\_paper\\_reprint\\_2017\\_web.pdf](https://www.acn.edu.au/wp-content/uploads/2017/10/acn_nurse_leadership_white_paper_reprint_2017_web.pdf)
- Helmreich, R. Does CRM training work? Air Line Pilot. 1991 May;60(5):17-20.
- Gaba D. Crisis resource management and teamwork training in anaesthesia. British Journal of Anaesthesia, 2010 July;105(1):3-6
- Higham H, Baxendale B. To err is human: use of simulation to enhance training and patient safety in anaesthesia. British Journal of Anaesthesia, 2017 Dec; (119, suppl 1): i106–i114. Available from: <https://doi.org/10.1093/bja/aex302>
- St.Pierre M, Hofinger G, Buerschaper C, Simon R. Crisis Management in Acute Care Settings: Human Factors and Team Psychology in A High Stakes Environment. 2Berlin Springer-Verlag 2007. Chapter 2; The challenge of acute healthcare [cited 2021 March 15]
- Hooijberg R, Watkins M. The future of team leadership is multimodal. MIT Sloane Management Review [Internet]. Cambridge, Massachusetts; 2021 [cited 2021 March 8]. Available from: <https://sloanreview.mit.edu/article/the-future-of-team-leadership-is-multimodal/>
- Nicolaidis VC, LaPort KA, Chen TR, et al. The shared leadership of teams: A meta-analysis of proximal, distal, and moderating relationships. The Leadership Quarterly 2014;25(5):923-42.
- Wang D, Waldman DA, Zhang Z. A meta-analysis of shared leadership and team effectiveness. Journal of Applied Psychology 2014;99(2):181-98.
- Frazier ML, Fainshmidt S, Klinger RL, Pezeshkan A, Vracheva V. Psychological safety: a meta-analytic review and extension. Pers Psychol 2017;70:113–65.
- De Brier N, Stroobants S, Vandekerckhove P, De Buck E. Factors affecting mental health of health care workers during coronavirus disease outbreaks (SARS, MERS & COVID-19): A rapid systematic review. Plos One [Internet]. 2021 Dec [cited 2021 March 11]. Available from: <https://doi.org/10.1371/journal.pone.0244052>
- Stajkovic AD, Lee D, Nyberg AJ. Collective efficacy, group potency, and group performance: meta-analyses of their relationships, and test of a mediation model. J Appl Psychol 2009;94:814–28. doi:10.1037/a0015659

## Realising the potential of anaesthesia technicians: The Royal Perth Hospital experience

### Peter Mulrooney, MB ChB, FRCA

Department of Anaesthesia and Pain Medicine, Royal Perth Hospital, Perth, WA

Dr Peter Mulrooney is a consultant anaesthetist and is the clinical manager of the Royal Perth Bentley Group Anaesthesia Technicians. He has extensive experience in managing departments of anaesthesia having previously been chair of the anaesthetic department at the University Hospitals Coventry and Warwickshire for eight years. In addition, he was co-clinical director of surgery and oncology and chair of the Senior Hospital Medical Staff Committee at the same hospital. Prior to that he was a senior specialist anaesthetist in the Royal Air Force. He has a long-standing interest in governance-based management coupled to patient and staff safety.

### Laura Prates Vitoria, MD, FANZCA

Department of Anaesthesia and Pain Medicine, Royal Perth Hospital, Perth, WA

Dr Laura Prates Vitoria is a consultant anaesthetist who holds the role of deputy clinical manager of the Royal Perth Bentley Group Anaesthesia Technicians. She completed her specialist training in Brazil and has worked in Australia for more than six years. In addition to her clinical interests, she invests heavily in teaching and staff support. She has developed an interest in the application of clinical governance in advancing patient and staff safety.

## INTRODUCTION

The anaesthesia department is the largest clinical department in metropolitan hospitals. The United Kingdom (UK) Audit Commission reported that anaesthetists are directly involved with two-thirds of hospital patients and are key to generating a remarkable proportion of hospital income at a pay cost equivalent to 3 per cent of this sum<sup>1</sup>. The anaesthesia department has also been in the forefront of advances in patient safety and clinical governance. None of this would be possible without the support of highly trained assistants.

A 1999 incident monitoring study<sup>2</sup> found "inadequate assistance" as a contributing factor to significant anaesthesia incidents identified in 187 reports (3.2 per cent), while suggesting that "skilled assistance" minimised the incident in 808 cases (18.8 per cent) – although the latter is difficult to prove retrospectively. Adverse outcomes in the report included prolonged stay, awareness and Intensive Care Unit (ICU) admission. Incidents were related to equipment, communication and inadequate staffing levels (number and/or skill mix). The impact on patient survival, quality of life and health system burden implicit in these figures argues for investment in a high quality well-functioning technician service.

Anaesthesia assistants fall broadly into two categories, technicians and nurses. In the Royal Perth Hospital (RPH) Department of Anaesthesia and Pain Medicine the vast majority of the anaesthesia assistants are technicians and in order to avoid confusion they are collectively referred to as anaesthesia technicians (AT).

The purpose of this article is to illustrate how a thorough review of the RPH anaesthesia technician service was undertaken and how subsequent developments were underpinned throughout by concentrating on clinical governance and the Australian and New Zealand College of Anaesthetists (ANZCA) standards.

## HISTORY OF RPH ANAESTHETIC TECHNICIAN SERVICE

The RPH is a tertiary level centre and serves as the adult trauma centre for Perth, Western Australia. It forms part of the Royal Perth Bentley Group (RPBG) of hospitals along with the smaller Bentley Hospital (BH). Between them, they have a total of 700 beds, 500 at RPH and 200 at BH. There are some 24 anaesthesia service locations (operating theatres and other sites), 20 at RPH and four at BH.

Historically, the technician manager had been directly answerable to the head of the Department (HOD) of Anaesthesia but was in reality largely left to operate independently. The structure of that service involved a management "group" comprising of the manager and two senior technicians (who acted as the daytime co-ordinators). The lines of communication were fluid in that there was an assumption of effective communication and dissemination if any of these individuals were approached. Managerial communications were largely issued without formal record. Over a number of years, it became apparent that this amorphous, informal and semi-detached model benefited neither the anaesthetists, the technicians nor, ultimately, the patients.

The increasing recognition of the importance of several aspects directly resulted in overwhelming pressure on the HOD. These aspects included: clinical governance, clinical developments, new equipment, new techniques

and practices, changing hospital priorities, the increasing impact of employment and occupational health regulations affecting both the anaesthetists and the technicians. By way of illustration, currently at RPH the consultant anaesthetic full-time equivalent (FTE) is 55, the trainee FTE is approximately 50 and the technician FTE is 43. The question that logically arose was whether the anaesthesia technicians should form a group to be considered as a discrete separate department in their own right or whether they should be integrated more fully within the Department of Anaesthesia (or potentially elsewhere). The anaesthesia departmental opinion was overwhelmingly that, given the commonality of purpose and the supportive skill profile, the anaesthesia technicians should remain as a discrete group within the Department of Anaesthesia.

In order to transition the technicians into a more governance-based entity, a senior managerially experienced consultant anaesthetist was identified to provide advice and liaise between the technician manager and the HOD. Within a short period, it became apparent that this model was insufficiently robust. As a consequence, a new executive post was formally established, that of clinical manager of the anaesthesia technicians.

## DEPARTMENTAL REVIEW

A number of governance-based audits and reviews were undertaken. These highlighted a lack of uniformity in drug and equipment provision throughout the anaesthesia areas along with out-of-date drugs being stored and equipment being utilised beyond identified service dates. It also became apparent that there was no detailed description of the technician's day-to-day duties, the job description form (JDF) being anodyne and lacking specificity. There was no plan to address fatigue management and safe working hours. There was no record of overtime worked. There were no records of continuing professional development (CPD) for individual technicians. There were no recorded quality assurance audits. Substantive support roles such as educators and administrative staff also did not exist.

Following this process, a strategy was put in place to address the identified problems.

### Departmental structure

A new technician manager was appointed, and a new management structure put in place. The technician manager now works under the direct supervision of the clinical manager (consultant anaesthetist). This provides a close level of support for the technician manager, strengthens strategic planning and facilitates an early warning system for potential problems. The technician manager is now supported by two assistants who interchangeably cover the RPH and BH sites. They are 0.5 FTE managerial and 0.5 FTE technician. This ensures that either one can step into the manager role as required while maintaining their technical skills. To ensure a verifiable audit trail, all communications are directed to the manager and confirmed in writing as appropriate. The daytime co-ordinator role is now shared between a cohort of six experienced technicians ensuring depth of resource, individual investment in the department and the development of organisational skills.

Two new 0.5 FTE educator/0.5 FTE technician positions have been created. These posts have a more senior designation but have no managerial role or responsibilities. They report directly to the technician manager. These posts were designed to both maintain technical skills and to minimise the complete loss of educator support when one or other is absent.

An administrative clerk position was also created, funded and filled.

This structure (see Figure 1) deliberately centralises all management activities in order to minimise miscommunication.

Figure 1. Flowchart outlining anaesthetic technicians line of management

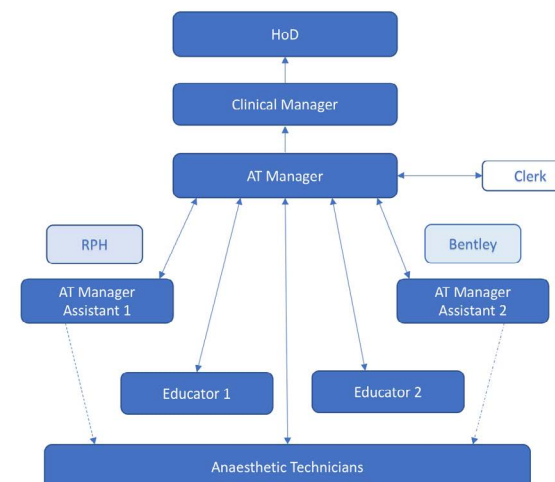

### Staffing numbers

Staffing here refers to staff who fulfil the ANZCA PS08<sup>4</sup> standard and who have successfully completed the RPH competency-based induction process. PS08 also stipulates that the hospital must ensure that staff numbers and rostering practices result in the allocation of a competent technician for every case where anaesthesia is administered. This number must allow for:

1. Annual leave.
2. Long service leave.
3. Personal leave (sick leave, carers leave, maternity leave, and so on).

At RPH, it was determined that the minimum staffing numbers for a shift would be based on the N+1 principle, where N equates to the number of tasks requiring attendance by technicians. The “+1” concept ensured that as a minimum there was at least one extra individual available for unexpected episodes. The +1 element is the shift co-ordinator who is responsible for dealing with the daily operational issues. The technician manager, the assistant to the manager and the educator are separate to these numbers.

A review of unexpected technician absences (most commonly due to sickness) revealed that at RPH there was a daily average shortfall of two technicians. This is unlikely to be unique. In addition, given the trauma and tertiary role of RPH, unplanned additional activity frequently occurs; therefore, there are two additional staff members rostered to the daytime shift over and above N+1.

In the event that N+1 is not achievable a formal escalation process is followed. Potential service failure must be identified at the earliest possible moment in order to prioritise services. The co-ordinator generates a report providing the staffing information in a standard format that is then provided to the duty anaesthetist. The co-ordinator will also seek to recruit off-duty or agency technicians (where possible, agency technicians familiar with the hospital are preferred). In the event of a life or limb threatening event the manager, assistant to the manager or the educator could step in, but this would be a rare interim measure while awaiting replacement staff. However, covering shortfalls with these individuals as a routine merely papers over the cracks rather than addressing underlying staffing deficiencies.

## DRUGS AND EQUIPMENT

Consultation was undertaken with the responsible consultant anaesthetist within the department as to what drugs, and in what quantity, were required to be available in the anaesthesia trolley in the operating theatre. The layout of the two relevant drawers was agreed and the conclusions implemented. A strict policy of checking and audit thereof was put in place.

The disposable equipment in the trolley was also reviewed and standardised. The same process was undertaken for the anaesthesia room attached to the operating theatre. These too are subject to the same audit process.

The “hard” equipment such as anaesthesia machines, syringe drivers, cell savers, infusion pumps and so on were listed in a register and the next service date noted. Close liaison with the service department was undertaken to ensure that the required service dates were logged, and the service appropriately undertaken in a planned and timely fashion. Checking the next service date forms part of the daily checklist. This is also subject to audit. Figure 2 illustrates examples of the setup standards required by the Department of Anaesthesia.

**Figure 2. Anaesthesia trolley, first drawer of the anaesthesia trolley, anaesthesia room**

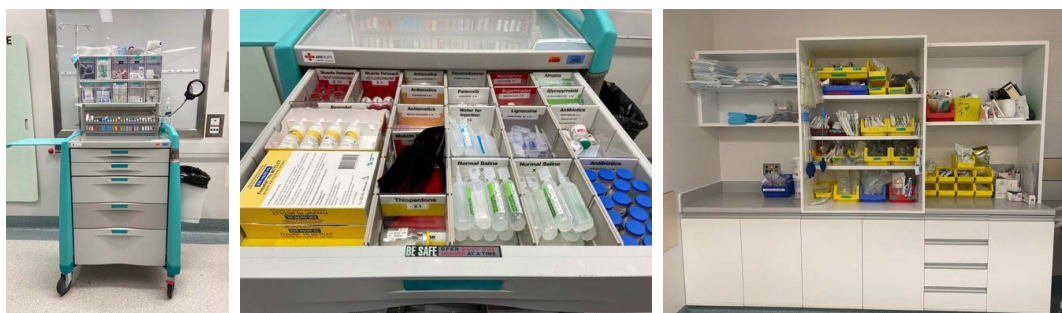

The audits undertaken are formally registered with the RPH Governance Evidence Knowledge Outcomes (GEKO) processes. Discrepancies are reviewed and managed as appropriate.

## SCOPE OF PRACTICE

Given the lack of a detailed job description for the technicians, managing inadequate performance was difficult since adequate performance had not actually been defined. A metric was needed. There was also a desire to create a more cohesive and engaged group identity. It was decided that these elements could be addressed by means of creating an overarching approach that would encompass both the generic departmental ethos and the specific activities of each member of the technician service.

Accordingly, two documents were created. The first document described the ethos of the department and the professional standards expected including objectives, processes and outcomes. It also referred to potential future developments.

The second document described in detail the duties and responsibilities of each technician role within the department. The document includes detailed requirements under the following headings:

1. Check/maintain the anaesthetic machine/ANZCA Level 2 check.
2. Prepare for the operating list.
3. Maintain stock levels in theatre.
4. Maintain stock levels in anaesthesia room.
5. Ensure drugs within the expiry dates.
6. Ensure compliance with S4/S4(R) drug protocol.
7. Ensure equipment prepared/maintained (service dates)/cleaned.
8. Standard skill set.
9. Advanced skill set.
10. Optional skill set and maintenance of CPD.

Every technician is required to acknowledge their understanding and acceptance of their role by signing this document. Addenda were also created to address the additional roles of the manager, assistant managers and educators.

The two documents were amalgamated into a definitive professional standards and scope of practice manual (see Figure 3).

**Figure 3. Anaesthesia Technicians Professional Standards and Scope of Practice booklet, front-page and index**

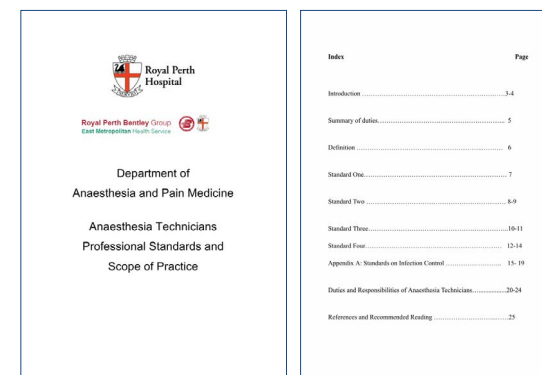

## FATIGUE MANAGEMENT

Proactive fatigue management is now a core process at RPBG. Clinical governance implicitly requires this. An all-too-often theme has been that the operating list must go on no matter what. This is a service-centric view. It does not prioritise patient or staff safety. The anaesthesia technician is a key member of the team and is integral to the safety strategies protecting the patient. If the technician is fatigued and pressured into continuing to work, then patient safety is compromised.

In the event of a shortage of staff, it is tempting to ask individuals to do double shifts, for example doing a morning session after a night shift. This is a dangerous practice. It has been shown that working 17 hours has the same performance deterioration as an alcohol level of 0.05. This is an issue not just for work performance, but also for homeward travel<sup>9</sup>. There is now a strict policy preventing double shifts for technicians at RPBG. In addition, adequate rest periods between duties, including call outs, are enforced. Overtime is also actively monitored to prevent excessive hours. If governance standards are threatened, operating lists are cancelled. This has led to the hospital investing in the technician FTE.

A further issue that affects fatigue is the on-call commitment. The RPH technicians have two staff members permanently sharing the single night shift with day staff rotating into night shifts to accommodate the shortfalls. On top of this there is a requirement for on call staff at night, on weekends and on public holidays. The pool of available staff is affected by the distance from the individual's home in that they must be able to reach the hospital within 30 minutes. A map with anaesthetic technicians out-of-hours travel time to Royal Perth Hospital was created to show their disposition and potential availability to be included in the on-call roster (see Figure 4). There is also the concept of a “biological contract” whereby once an individual reaches a certain age, they should be considered for opting out of the on-call roster. Currently the on-call frequency is approximately twice per month.

**Figure 4. Illustration of anaesthetic technicians travel times to Royal Perth Hospital**

Each icon represents one individual.

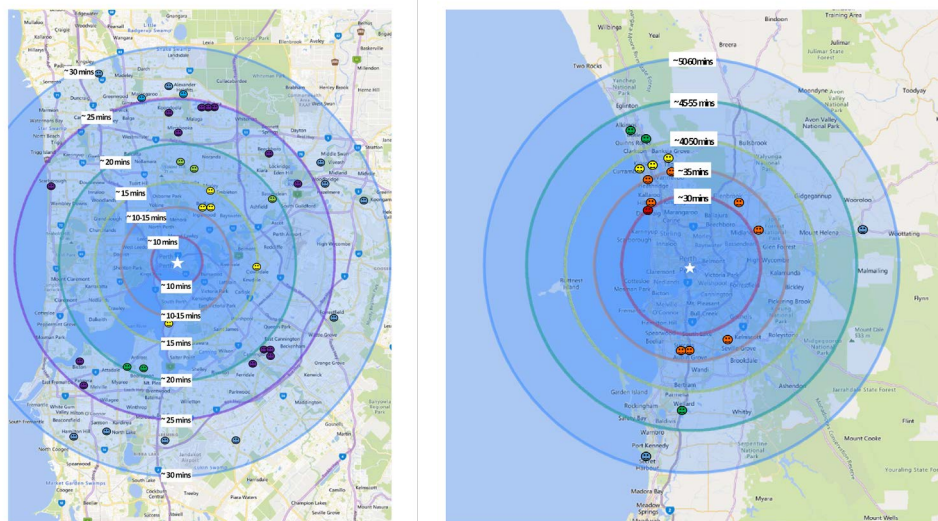

## TRAINING

Throughout Australia, the degree of training and experience of the anaesthesia assistant can vary from no formal qualification through to completion of a formally recognised course. Technician training at RPH commenced in an ad hoc fashion in 1966. Almost 30 years later in 1995, an accredited competency based RPH training program was registered in Western Australia (WA). In 2000 this transitioned to a technical and further education (TAFE)<sup>5</sup> administered WA program and finally to a national standard in 2004. In 2013 the training program was fully transferred to the Central Institute of Technology (CIT) located in Perth. The qualification awarded was the Certificate IV of Anaesthetic Technology. In 2016 CIT became part of North Metropolitan TAFE. This qualification has now evolved to become the Diploma of Anaesthetic Technology (HLT57915)<sup>6</sup>. PS08 provides guidance on what standards the course should encompass.

The diploma course is part-time and includes practical, hands-on activities in a classroom format as well as in a well-designed simulated anaesthesia technology laboratory. It also includes vital clinical placements in multiple hospitals in the Perth metropolitan area organised by the TAFE. It is suggested that the course equips those qualified to be industry ready after a two-year course. Unfortunately, the course falls short of compliance with PS08 in that the period of supervised clinical training is far less than 12 months. The total number of hours required to comply is calculated by RPH to be 1748 (38 hours per week for 46 weeks). The current total number of hours of supervised practice in the TAFE course is approximately 400, that is, the equivalent of 10.5 weeks.

The RPH Department of Anaesthesia and Pain Medicine recognised the training shortfalls and has, as a consequence, formalised a standard whereby the anaesthetic assistant, whether nurse or technician, must be trained to the diploma or equivalent level and conform to PS08.

The importance of the 12-month clinical supervision period is emphasised by the identification that the development of cognitive non-technical skills by the technician is an essential component in contributing to the safe practice of anaesthesia<sup>7</sup>. At a basic level this means that the technician accumulates the skill to understand at an early stage when something is going wrong during a procedure and is thus able to anticipate what may be required to mitigate the danger, that is, situational awareness. This is only possible after sufficient clinical exposure and supervision. As a consequence, new appointees have their supervised clinical exposure during training reviewed and any shortfall of the 12-month supervised training standard is made up before consideration is made to allow the appointee to operate “solo”. In addition, a formal competency-based induction process is undertaken for all newly appointed technicians regardless of their experience, when they receive an Orientation and Induction booklet to familiarise themselves and keep record of the process (see Figure 5). Each competency must be signed off by both the supervisor and the new technician. This ensures that this is not simply a “box ticking” exercise.

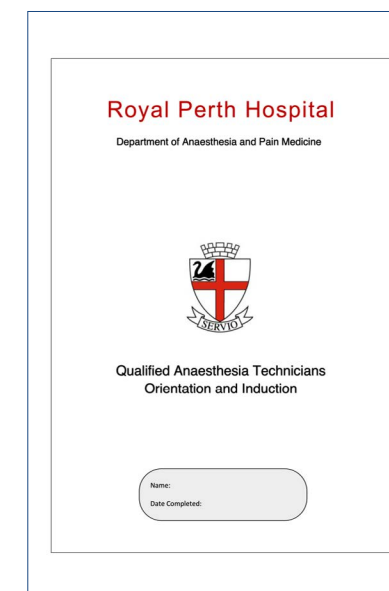
**Figure 5. Anaesthetic technicians' orientation and induction booklet front page**

Making up the shortfall in supervised training and the competency-based induction has significant cost implications for the hospital; therefore, a business case was put forward to appoint two trainee technicians at RPH from the cohort attending TAFE at a lower salary scale than that of a qualified technician. They would in effect undergo paid supervised training and induction as part of their normal activities. This was successful and two trainee posts have been maintained since. Of the trainees who have undertaken these positions to date, six (66 per cent) have been appointed to full-time posts at RPH.

## EDUCATORS

Having identified both the technician training shortfall and the lack of formalised training support within this skill group, a successful business case was put forward to appoint two 0.5 FTE educators.

The educator must possess the Certificate IV Training and Assessment (TAE40116) qualification or its equivalent. Their technician role is maintained by ensuring a 50:50 educator/technician balance.

The educators oversee the TAFE trainee attachments and ensure that their exposure to the clinical environment is appropriate. They also administer the RPH induction program for new appointees.

As per PS08, anaesthetic technicians must maintain and upgrade their knowledge and skills with regular education activities. At RPH this is underwritten by weekly one-hour education sessions. In addition, the technicians have mandatory hospital updates. They are also encouraged to undertake individual online learning activities. When new techniques or equipment are proposed, the educators are responsible for designing, implementing and recording their safe introduction. An important role of the educators is to organise and facilitate all these activities and to ensure each technician has an up-to-date continuing professional development (CPD) portfolio.

## HEALTH AND DEMOGRAPHICS

The impact of staff health episodes is significant since the practice model is based on the expectation of solo practice. It cannot be assumed that help is immediately available. At RPH, a standard approach for all technician health issues was instituted, unless minor in nature, in that a formal review is required by the occupational health department. The conclusion of that review had to be that there are no limitations to activities before the individual can be considered as fit to return to solo technician duties. To assist in this process, the Professional Standards and Scope of Practice document was supplied to the occupational physician. However, the final decision remains that of the clinical manager.



In addition, it is vital to assess the age demographic. This is by no means an exact science, but the higher the proportion of older staff, the higher the risk of absences through sickness, prolonged recovery periods and potential retirements.

## COMMUNICATION AND RECORDS

The scope of technology to enhance interpersonal communications is wide. That said, no department can operate in a fashion to accommodate each technician's personal preferences. Accordingly, it is vital that a standardised method of communication is established and promulgated. Hence, at RPH, the only accepted forms of official communication are the global email address, an officially sanctioned app group or personally addressed mail. This approach guarantees an audit trail and provides protection for both the employer and the individual employee.

## ROLE OF THE CONSULTANT ANAESTHETIST

While standards and expectations can be set by the managers, the anaesthetist (whether consultant or trainee) is the team leader and is responsible for maintaining those standards in the clinical setting. If a technician underperforms, the anaesthetist should identify this to the technician and if the issue persists or if the issue is serious, this should be formally brought to the attention of the manager. Problems can only be addressed if highlighted and the anaesthetist has a duty to identify such problems.

## CONCLUSION

Anaesthesia technician "functionality" is not an end in itself, it is just the beginning. The question that arises is whether there is an enhanced role for the technicians and whether that can be achieved on a basis that leads to professional registration. The advantage of this step is that national standards would transcend local control and thus strengthen governance, hospital standards and hence patient safety both in the metropolitan and country environments.

## REFERENCES

1. Audit Commission: Anaesthesia under examination. The efficiency and effectiveness of anaesthesia and pain relief services in England and Wales (national report), 1997 Dec. Report No.: ISBN 1 86240 060 1
2. Kluger M, Bukofzer M, Bullock M. Anaesthetic Assistants: Their Role in the Development and Resolution of Anaesthetic Incidents. *Anaesthesia and Intensive Care*. 1999 June; 27(3): 269-274.
3. Transport for New South Wales. Fatigue. 2021. Available from: <https://roadsafety.transport.nsw.gov.au/stayingsafe/fatigue/index.html>
4. Australian and New Zealand College of Anaesthetists. PS08 Statement on the assistant for the anaesthetist [internet]. 2016. Available from: <https://www.anzca.edu.au/getattachment/473f7e0d-b14a-4939-aad1-034c0474c603/PS08-Statement-on-the-assistant-for-the-anaesthetist>
5. Olivia Blazevic. What is TAFE (Technical and Further Education) and How Can it Benefit You [internet]. Australia: TAFE courses; 2018 [cited 2018 Feb 25]. Available from [https://www.tafecourses.com.au/resources/what-is-tafe/?ab=1&utm\\_referrer=https%3A%2F%2Fwww.google.com](https://www.tafecourses.com.au/resources/what-is-tafe/?ab=1&utm_referrer=https%3A%2F%2Fwww.google.com)
6. TAFE. Diploma of Anaesthetic Technology [internet]. Western Australia: North Metropolitan TAFE. 2021. Available from: <https://www.northmetrotafe.wa.edu.au/print-pdf/node/2162>
7. Rutherford JS, Flin R, Mitchell L. "They seem to be able to read your mind." An interview study to identify the cognitive non-technical skills of anaesthetic assistants. *J Periop Pract*. 2015 September; 25(9): 155-159.

## Socrates, Plato and the healthcare worker's duty to serve

### Elizabeth Hessian MBBS MPH FANZCA

Western Health, Victoria, Australia

Dr Liz Hessian is an anaesthetist, deputy director of the Department of Anaesthesia, Pain and Perioperative Medicine at Western Health, and honorary clinical fellow in the Department of Critical Care, University of Melbourne. She has an interest in organisational improvement facilitating well-being of healthcare workers and high-quality patient care.

### Julian Savulescu FAHMS

University of Oxford, Oxford, United Kingdom

Professor Julian Savulescu is an Australian philosopher and bioethicist. He is Uehiro chair in practical ethics at the University of Oxford, director of the Oxford Uehiro Centre for Practical Ethics, co-director of the Wellcome Centre for Ethics and Humanities, visiting professorial fellow at the Murdoch Children's Research Institute and Distinguished International Visiting Professor in Law, University of Melbourne.

## INTRODUCTION

*Non nobis solum nati sumus*

*Not for Ourselves Alone are We Born*

— Marcus Tullius Cicero

Throughout the centuries, societies have looked to the caring professions in times of health crisis, and in response, healthcare workers can boast a long history of serving their patients regardless of the hazards. In recent times, the culture of duty to serve has become eroded by an increasing emphasis on self-determination and a transactional approach within the healthcare worker (HCW)/patient relationship. We examine the tension between duty to serve and personal autonomy, and place the four traditional medical ethical principles of beneficence, non-maleficence, justice and autonomy within a layered framework that takes account of societal context and values. These issues are teased out in a hypothetical discourse between two moral philosophers Socrates and Plato, who use a process of reflective equilibrium to resolve the following question: Should healthcare organisations ethically be able to compel healthcare workers to serve during a pandemic, regardless of unavoidable personal risk?

## THE DUTY TO SERVE

From ancient times, civilisations have feared contagion. The renowned physician Galen was infamous for running from the Roman smallpox epidemic in 166 AD<sup>1</sup>. Middle Ages writings point to the contagious nature of "the pest" with many physicians urging flight to remote locations.

Those infected seeking help faced varying responses<sup>2</sup>. "For every account of a... physician hiding in terror... there are descriptions of... physicians trying desperately to help their patients, and priests administering the sacraments to the dying<sup>3</sup>." It is difficult to know the scale of physician flight, but Amundsen concludes a general condemnatory attitude towards doctors who abandoned their plague patients to protect their own safety.

Changing attitudes more recently are captured by the evolution of the American Medical Association (AMA) Code of Ethics. In 1847, the code was explicit as to physician responsibility: "when pestilence prevails, it is [physicians'] duty to face the danger and to continue their labors for the alleviation of suffering, even at the jeopardy of their own lives<sup>4,5</sup>." By the 1950s, in response to diminishing physician autonomy and increasingly powerful insurers, the code only required physicians to assist in emergencies<sup>4</sup>. The softened wording might also have reflected increasing complacency given advancements in medical care.

This complacency was abruptly interrupted in the 1980s by the emergence of HIV/AIDS<sup>6</sup>. HCWs, who for decades had enjoyed a high level of workplace safety, were faced with a contagious illness that led inevitably to a debilitating and early death. The disease was initially most prevalent in two widely vilified groups, homosexual men and those who injected recreational drugs. Discriminatory attitudes and limited knowledge of HIV transmission saw HCWs refusing to treat infected patients<sup>7</sup>, including in 1992, in 40 per cent of Japanese hospitals<sup>8</sup>.

The AMA responded initially with a widely ridiculed statement that treating HIV positive patients was only required if physicians were "emotionally able<sup>4</sup>". Today it takes a middle ground acknowledging duty balanced with personal risk management:

“Because of their commitment to care for the sick and injured, individual physicians have an obligation to provide urgent medical care during disasters... [P]hysicians also have an obligation to evaluate the risks of providing care to individual patients versus the need to be available to provide care in the future<sup>9,10</sup>”

The evolving AMA code illustrates the profession grappling to reconcile established moral principles with competing societal influences. An Australian study by Seale and colleagues in 2009 found that 83 per cent of HCWs would continue to work during a pandemic<sup>7</sup>. The authors noted the varying results across similar international surveys, including in the US where studies showed only around half of all HCWs would continue working<sup>11,12</sup>.

The Severe Acute Respiratory Syndrome (SARS) and other disease outbreaks offer further insights. In the 2003 SARS pandemic many facilities faced staff shortages, and martyrs to the cause experienced disproportionately higher exposure to risk when covering for absent colleagues<sup>10</sup>. This was evidenced again in the 2009 H1N1 pandemic where absenteeism was seen in 30 per cent of HCW in the US, 40 per cent in Argentina, and in New Zealand it created temporary stresses in hospitals<sup>13</sup>. Factors contributing to absenteeism were fear of the unknown, shortages of personal protective equipment (PPE), as well as what some researchers have termed “weakly conceptualised or poorly understood duty of care<sup>13,14</sup>”. In relation to the SARS outbreak Singer and colleagues “could not reach consensus on the issue of duty to serve, particularly regarding the extent to which healthcare workers are obligated to risk their lives in delivering clinical care”. To answer this question, they urged “urgent attention from researchers, regulatory bodies, and the public<sup>15</sup>”. Unfortunately answers were not available when the latest pandemic hit.

In January 2020, news filtered out from China of a novel human coronavirus, SARS-CoV-2 causing COVID-19. Since that time, the pandemic has circled the globe, overwhelming healthcare systems in many countries.

Healthcare workers standing on the frontline risked contracting the disease, sometimes with dire consequences. Early data estimated the risk of HCWs contracting COVID-19 at one in 200, with 15 per cent of those experiencing severe illness and one in 1000 dying<sup>16</sup>. In addition, many HCWs faced the moral distress that came from denying scarce resources to those who would normally receive a full suite of treatments – intensive care unit (ICU) beds, ventilators, or even oxygen<sup>17-19</sup>.

At a time when hospitals desperately need their most valuable asset – experienced, trained staff – those staff are questioning how much they could, or should contribute in the face of personal risk.

Such tensions indicate that organisations cannot necessarily rely on HCWs to serve under all circumstances during a pandemic. We therefore need to understand the drivers that lead HCWs to step up during adversity, and the spectrum along which the answers lie as to whether HCWs can be compelled to work.

At one extreme HCWs have an absolute duty to work during a pandemic, always placing patient need above personal concerns. This position of martyrdom compels the troops to scramble over the trenches thinking only of duty. It could be represented as a “calling”, a position articulated by one spiritual leader in a study of community views: “[T]hey undertake a particular calling—whether it’s in medicine or leading a faith community or as a soldier... who have chosen that as a vocation<sup>20</sup>”.

The polar opposite emphasises HCW self-determination, with a “transactional” relationship between parties where the vendor is free to choose hours worked, fees charged, and choice of risk undertaken. This position was encapsulated following the emergence of HIV:

[H]ealthcare has been largely a product of the free market, carrying with it no obligations binding physicians to treat those needing medical attention<sup>21,22</sup>.

The medical care system is steeped in individualism and autonomy... Medical care operates on the free market system and physicians are its free agents<sup>21</sup>.

A middle ground achieved through reflective equilibrium may be possible. To do this we have created a hypothetical dialogue between two philosophers – Socrates and Plato. Socrates’ original position supports the “calling” approach: HCWs have a moral duty to provide care during a pandemic. Plato argues for healthcare being transactional: that as autonomous persons, HCWs can choose to absent themselves during a pandemic. Through their dialogue, the philosophers move to a middle ground: a moral position supporting HCWs compelled to work only when organisations account for individual circumstances, mitigate risk by strict mutual obligation, and are subject to relevant societal contextual factors<sup>23</sup>.

To reach consensus, the philosophers engage in a process of reflective equilibrium, described by John Rawls, where decisions are “negotiated in a ‘process of mutual adjustment of principles and considered judgements,’”<sup>24,25</sup> in order to bring principles and judgements into equilibrium.

Reflective equilibrium is a philosophical method seeking a goal of fairness exemplified by society being “‘a cooperative venture for mutual advantage’, produc[ing] by its collaborative effort a net surplus of advantages and benefits<sup>25,26</sup>”.

In order to reach the “ideal society” position from “behind the veil of ignorance<sup>25,27</sup>”, the philosophers will need to consider multiple perspectives: HCWs, patients, healthcare organisations, and society as a whole, as well as the four pillars of medical ethics (beneficence, non-maleficence, justice, autonomy) and build a model that embeds these principles within the complexity of societal context.

## THE PHILOSOPHERS MEET

Our meeting of Socrates and Plato begins with them reviewing the four key medical ethical principles.

### Beneficence

Socrates starts by invoking the principle of beneficence. “In modern health care... the principle of beneficence constitutes a foundational principle of the patient-provider relationship<sup>10,28</sup>”.

HCWs are expected to deliver compassionate care, and in return, they are accorded respect, remuneration and often subsidised training. They therefore have both a moral duty and an implied societal contract to continue to serve regardless of a changing risk environment<sup>23</sup>.

Plato responds that this is a simplistic view of the relationship between beneficence and a duty to care. What if by plunging into the conflagration, a HCW becomes fatigued, mentally or physically unwell, causing suboptimal performance, risk of spreading further infection, requirement to step down or diversion of health resources towards her own care? Plato paraphrases Aristotle: “Courage unmatched by wisdom often leads to rashness... to behaviour that undermines optimal effectiveness, improves nothing, and may even cause greater general harm than good<sup>24</sup>”.

Socrates suggests that HCWs should expect of themselves a baseline level of beneficence, a “moral minimum”. Thomson wrote of a duty to assist in the case of the stabbing murder of Kitty Genovese whose plight was witnessed by no less than 38 people, none of whom tried to assist or even call the police<sup>24,29</sup>. Simon et al developed this argument into one of a “moral minimum” to assist in times of “critical human need”<sup>24,30</sup>.

Socrates agrees with Plato, in only that beneficence should be considered broadly. Beyond duty to patients lies a duty to hospital, colleagues and profession, to the loved ones of patients, and a responsibility to maintain a robust body of scientific knowledge<sup>23</sup>. These broader duties are encompassed by the term “professionalism”.

This sense of obligation towards one’s colleagues was movingly expressed by Ear, Nose and Throat (ENT) residents in New York volunteering to set up a COVID-19 surge ICU:

Before we began, we reflected on our privilege. How lucky were we to have the opportunity, the choice, to volunteer in contrast to some of our colleagues? We, as otolaryngologists, as subspecialists, were in this moment not special, but physicians like everyone else. It was our duty to help lighten the load of our colleagues<sup>31</sup>.

As Socrates and Plato continue to talk, it becomes apparent that although the principle of beneficence could either support or negate a compelled duty to serve, a “sum of vectors” approach appears more supportive of Socrates’ position. This approach is further developed later as they develop their solution model.

### Non-maleficence

Perhaps the most important argument for the principle of non-maleficence supporting a duty to work, Socrates claims, relates to the loss of public trust should HCWs abandon their posts.

Population surveys rate nurses the most trustworthy of all professions; doctors and other HCWs scoring only slightly lower<sup>32</sup>. A perception that HCWs are stepping back during times of danger runs the risk of destroying hard-won trust in the caring professions<sup>23</sup>. Lost trust may result in patients who are less motivated to present, follow advice, and even miss the beneficial placebo effect that may arise from the therapeutic relationship.

In order to prevent reputational harm to the caring professions, Socrates argues that non-maleficence – to their professions’ reputation – should guide HCWs to remain steadfast in the face of danger.

Additionally, Socrates points to the high levels of training of HCWs. Non-maleficence should be just as applicable to professional colleagues as to patients, and there is risk to less experienced HCWs who cover those who have left<sup>4,10</sup>. “[T]raining not only increases the value of the aid, it may also reduce the risk associated with providing it<sup>24</sup>”.

Plato counters by extending non-maleficence further to healthcare organisation obligation to avoid harm to its staff. If knowing that, for example, an older male anaesthetist has a higher baseline risk than others, how can that organisation ethically require him to work? And what of risk to HCW emotional wellbeing in working beyond their usual scope of practice? “For the first time, many of us were truly scared to go to work, to hurt the patients, to not be able to emotionally manage what we were seeing. We were not trained in critical care<sup>31</sup>.” Plato then describes further harms to the profession: surveyed HCWs abhor punitive measures to compel working that may deter new members from joining the profession and encourage existing members to leave<sup>18</sup>.

Socrates counters stating that organisations can impose such obligations, but only if they have maximised measures to reduce workforce risk. The philosophers start to shift their absolute positions to consider risk mitigation by mutual obligation<sup>23</sup>.

Socrates draws on Singer in considering this question.

The value of reciprocity requires healthcare institutions to support and protect healthcare workers, to help them cope with very stressful situations, to acknowledge their work in dangerous and difficult conditions, and to have workable plans for emergency situations<sup>13</sup>.

Studies of essential workers indicate that although a high proportion are willing to step up during a pandemic, they may be prevented from doing so by personal circumstances<sup>33</sup>. Organisations can support HCWs by providing reciprocal incentives such as care of children, pets or older frail relatives, commute and accommodation alternatives, and flexible work hours.

The philosophers start to consider how reciprocity also supports the next ethical pillar, that of justice.

### Justice

Justice requires that patients are treated fairly, particularly when resources are limited. Justice also applies to the obligations by organisations, governments and society towards HCWs with respect to mutual obligation and reciprocity<sup>23</sup>.

How can reciprocal obligations of healthcare organisations help support a just approach? Surveys show HCWs prefer their drivers to be carrots rather than sticks, favouring an approach that “creates a supportive environment for personal decision-making,” that respects “individualised circumstantial limits”<sup>11</sup>.

Increased remuneration is a potentially attractive incentive. During SARS, HCWs treating infectious patients received additional financial reward with Vietnam paying up to five times usual salaries<sup>34</sup>. However, care is required to ensure that financial incentives achieve their desired outcome. Some Toronto hospitals created pay discrepancies between hospitals in close geographical proximity; aggrieved nurses complained that they were not receiving similar benefits to their colleagues. Organisations need to fully consider less tangible impacts such as undermining a key motivator to work – loyalty to colleagues<sup>23</sup>.

The carrot approach *can* be tailored to provide benefit to both HCWs and their employers. Ensuring early access for HCWs to vaccines and therapeutics, especially in scenarios of limited supply, would be popular and also advantageous to organisations with an eye to maintaining good workforce health. Such approaches also shift the incentive beyond the purely monetary to that of improved health and wellbeing. This approach speaks to equity, providing an incentive that is just as valuable to the wealthy as it is to the poor<sup>34</sup>.

### Autonomy

Plato now moves to arguably the most prized of the medical ethical principles, that of autonomy. Autonomy allows HCWs to determine their own course by evaluating personal risks and benefits<sup>23</sup>. Our older male anaesthetist has his own health at stake, and Plato argues he has the right to protect himself.

By allowing HCWs autonomy, Plato argues they will make the appropriate personal choices to maintain health and wellbeing, thus ensuring a sustainable and high-quality service to their patients.

Socrates counters saying that HCWs will not necessarily weigh risks accurately. Some HCWs will inevitably stray too close to the precipice, failing to self-protect sufficiently, others may overweight their personal risk in calculating the equation. “[T]he limits may be institutionally imposed... [recognising] the problems of [the agent] making such value judgments<sup>35</sup>.”

But to ensure a humane society, Plato insists we should always place autonomy at the pinnacle of medical ethics lest we travel the slippery slope taken by the Nazi regime. Michael Kirby has eloquently described the stain left on our history from the regime’s barbarism.

There will always be memories of the Holocaust. Even when every distorted mind that conceived and executed the oppression is dead, there will be memories. They are written into the consciousness of humanity forever. Human beings everywhere will continue to recall the pitch-black moments of human history that came together in the Holocaust<sup>36,37</sup>.

At the Nuremberg trials, Nazi doctors justified their inhumane experimentation on non-consenting prisoners by claiming research was necessary for national security and the greater good<sup>37</sup>.

Their argument that societal need trumped individual autonomy was roundly rejected by the trial judges. From these trials emerged the Nuremberg Code, whose first principle was that “the voluntary consent of the human subject is absolutely essential<sup>37</sup>”. “[L]ack of respect for autonomy became lack of respect for human life and indifference to the infliction of pain and murder<sup>37</sup>” – surely a path that healthcare organisations should avoid at all costs.

Socrates agrees that the principle of autonomy is paramount to ensuring a humane society. But, he says, HCWs have full autonomy, having consented to joining professions with known occupational risk<sup>38</sup>. HCWs experience occupational violence at the hands of angry or delirious patients, incur needle-stick injuries causing chronic infectious diseases, suffer higher rates of mental illness and suicide, and, are on the frontline to respond during pandemics<sup>10</sup>.

Plato counters, saying that the HCW may not have been aware of the *particular* risk in serving during a pandemic, especially given there were many decades in the 20<sup>th</sup> century that were mercifully free of widespread contagion<sup>35</sup>. The influenza outbreaks that occurred during the middle of the 20<sup>th</sup> century, H2N2 (“The Asian Flu”, 1957-8) and H3N2 (“The Hong Kong Flu”, 1968-70), although widespread, lacked the societal punch of the earlier Spanish flu pandemic<sup>39</sup>. Have HCWs really consented if they were unaware they would need to contribute during an outbreak of a serious communicable disease?

Socrates concedes that the risks have varied over time but argues that there has been sufficient temporal proximity to infectious disease outbreaks during the entirety of the 20<sup>th</sup> century for HCWs to be at least aware of the impacts on their profession, even if individuals had not been personally affected<sup>10</sup>.

Plato argues that compelling HCWs to work against their will during a pandemic is comparable to other states of involuntary servitude such as military conscription<sup>34</sup>.

Socrates concedes this point, but muses that military analogies might provide useful examples of how informed consent *and* reward for those who choose additional risk could benefit HCWs. Malm et al developed this idea:

[T]raditionally epidemics have not been met with the expectation that all doctors serve equally, but with the financing of cadres of “plague doctors” or with the exploitation of existing pools of military medical personnel... who are habituated to following orders and accepting risk<sup>35,40</sup>.

Structures allowing rapid deployment of fully consented HCWs include corps of compensated or volunteer individuals, specifically trained in infectious diseases management. The National Guard is cited as an example of such cadres, but perhaps models more relevant to the Australian setting include Surf Lifesaving Australia and the volunteer Country Fire Authority.

Socrates and Plato have arrived at an impasse but have nonetheless created a foundation supported by the four medical ethical pillars. They decide to consider their arguments as a “sum of vectors” before adding further dimensions in a layered model that will move them closer to an answer.

### Sum of vectors analysis

One original way to make progress in practical ethics is the “sum of vectors” approach. On one view of ethics, ethics is about weighing reasons. Reasons are like forces in physics. They have a direction and a strength. In physics, we discover the overall force (which way the ball should roll) by summing these different vectors. In ethics, we must also “sum the reasons” to discover what we have overall most reason to do.

It is important to recognise that different factual circumstances (context) may affect the strength but not the direction of a single vector. Thus, under conditions of abundant resources, the vector of distributive justice is much weaker than when resources are scarce. This may change what we have overall most reason to do in different contexts, even though the same vectors are operative.

The philosophers’ arguments are summarised in Table 1 and Figure 1 illustrating a vector analysis of the four ethical principles, and a total sum of vectors. A value of zero on the Y axis indicates a state of equipoise for the question, and an arbitrary value of 1 and -1 has been assigned to factors supporting a “calling” and “transactional” approach respectively.

**Table 1. The philosophers' arguments**

	Argument	"Calling" (1) "Transactional" (-1)
<b>Beneficence</b>	Senseless martyrdom	-1
	Complexity of competing duties	-1
	Care of patients	1
	Societal contract	1
	A HCW moral minimum	1
	Obligation to care for profession	1
<b>Non-maleficence</b>	Obligation of organisation to protect HCWs	-1
	Loss of HCWs from professions	-1
	Reputational harm to profession	1
	Harm to less experienced HCWs	1
<b>Autonomy</b>	Autonomy ensures a humane society	-1
	Consent ensures autonomy	1
	Autonomous decisions may be biased	1
	Consent not fully informed	-1
	Ignorance of risk not a defence	1
	Involuntary servitude	-1
	Preparation can ensure consent	1
<b>Justice</b>	Fairness to HCWs by organisations	-1
	Fairness to patients by HCWs	1
	Utilitarian argument	1
	Mitigation of risk by organisational reciprocity	1

HCW = healthcare worker

**Figure 1. "Sum of vectors" analysis**

This figure shows the "sum of vectors" analysis for the data in Table 1.

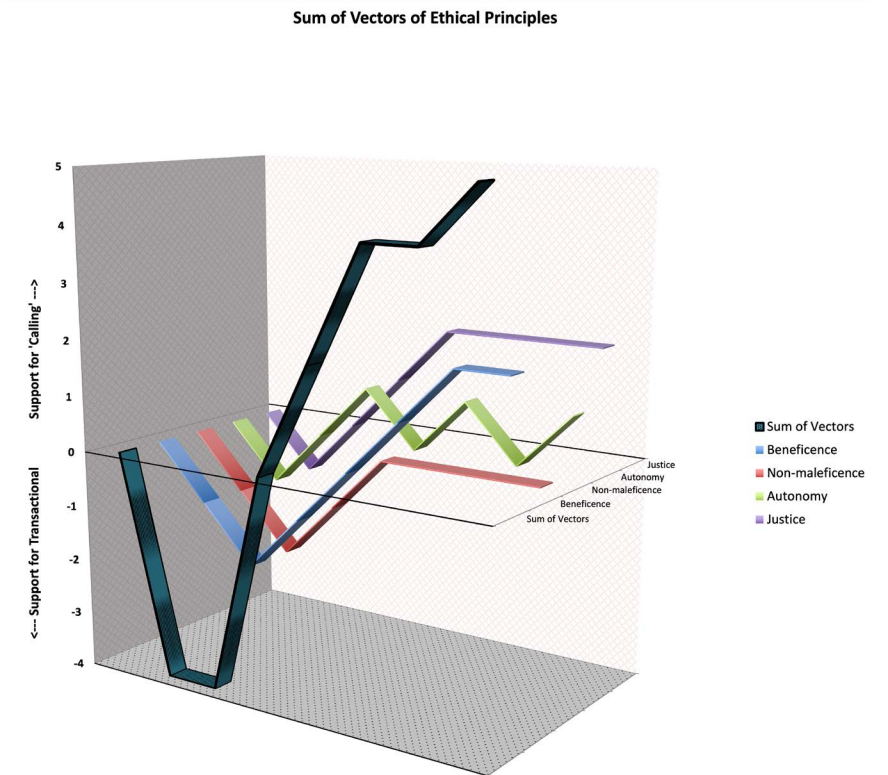

Although Socrates' position is stronger using this somewhat blunt instrument, Plato also has significant points on the board. Both agree that the fundamental principles should not be discarded, as the arguments for each side using these principles appear well-founded and coherent. Rather, their initial starting judgements of answer extremes will need to be adjusted to ensure equilibrium with these foundational principles.

These adjustments include weighting risk for both HCWs and actions and considering how different societal contexts could shift their model along the axes.

#### Personal risk, risk of an act

Socrates and Plato agree on one point: that duty and a sense of vocation are key ingredients for the caring professions. They also agree that during times of unprecedented disruption, every person in society has obligations beyond the usual. The point on which they disagree is how extreme a risk should be taken to fulfil those obligations. And should all comers contribute equally?

Ethicists consider acts of service as either reasonable duty or supererogatory. Urmson described this distinction as dividing

“the good that we expect of one another (our duties) and the good that one may hope for or aspire to or admire in others but that is above and beyond the call of duty and outside the realm of ordinary socially-enforced obligations, i.e. the supererogatory<sup>41-43</sup>.”

Another description of supererogatory acts relates to others' expectations: “acts that go beyond our duty... are ones we are praised for doing and are not blamed for not doing<sup>35</sup>.” Finally, somewhat poetically: “Supererogatory acts arise from a movement of the soul toward generosity beyond previously known boundaries for that person<sup>44</sup>.”

An example of supererogatory act would be rushing into a cardiac arrest of a COVID-19 positive patient without first donning PPE. Such an act is considered to be beyond the call of duty, despite measurable harm to patients of delayed resuscitation.

Authors have expanded the binary notion of duty versus supererogatory acts into more gradated levels. Clark invokes the biblical story of the good Samaritan who stopped to check an injured Jew by the side of the road, bound his wounds, transported him to a nearby town, and provided for his ongoing care. Not only a service of great compassion, but all the more telling because of the historical enmity between the Samaritans and the Jews. Ruderman ponders “whether the acceptable standard of professional engagement should occur at the level of ‘[splendid]’, ‘good’, or ‘merely decent’ Samaritan<sup>10,29</sup>”

The philosophers shift from the *what* of the duty to the *who*. Are all equal with respect to obligation?

A radiologist, who exclusively works remotely interpreting images sent to her home office, could justifiably argue that she had made a choice to accept relative professional isolation for the benefit of reduced occupational risk. Shifting to activities beyond her usual practice – perhaps manning a COVID-19 testing station – could be seen as an act of at least a “good” Samaritan.

Furthermore, we must consider inequalities between the professions. Should not the doctors sitting at the privileged pinnacle of the system be required to contribute more during times of emergency, in recognition of benefits of higher remuneration, autonomy and societal deference they enjoy during times of prosperity? Nurses may incur greater risks given extended contact with patients, and will have enjoyed fewer professional tangible benefits<sup>35</sup>. Healthcare organisations should carefully consider these inequalities and determine a reasonable expectation of each HCW.

When assessing human research, regulators risk stratify both research interventions and participants. In particular, vulnerable groups such as children, pregnant women and Indigenous research participants are identified for special consideration<sup>45</sup>.

Drawing on this paradigm, Socrates proposes that both the activities and the personal risk inherent in HCW age, experience and health, could be better matched. Clark describes a sliding scale, where “as individual risk increases, the responsibility to render aid diminishes<sup>24</sup>”. This approach was applied by Reid with respect to HIV: “According to the framework of the HIV/AIDS debate, obligation sinks with rising levels of risk and there is a level of risk at which the duty to serve no longer holds<sup>42</sup>”.

Socrates is therefore moving away from his original judgement of an absolute duty to serve towards a more nuanced position where the healthcare organisation is responsible for understanding individual HCW and clinical activity risk and deploying staff accordingly.

With good human resource management, our older male anaesthetist could be redirected from the intubation service to the preadmission clinic now operating by telehealth. Here he could optimise patients awaiting critical surgery, freeing up his younger, fitter colleagues to provide care in the riskier clinical environments.

The philosophers now add a third dimension to their model – that of societal context.

## THE CHANGING CONTEXT OF THE HEALTHCARE WORKER/PATIENT RELATIONSHIP

What time in history, what country, what health resources, but probably most importantly, what societal attitudes and expectations of HCWs can guide further nuanced movements within our model?

[T]he limits to the duty to care [serve] cannot be left simply to personal choice or an appeal to morality that emerges from an individualized notion of caring... duty to care ought to be weaved within the fabric of society in order to provide HCPs with the conditions and resources necessary to satisfy their duty, rather than based on an ethic derived entirely from individual obligations<sup>20</sup>.

In articulating this position, Bensimon et al are suggesting that societal attitudes can relieve HCWs of the bulk of the decision-making burden regarding duty to serve<sup>46</sup>.

What is it that societies expect of their caring professions? Attitudes have fluctuated with respect to what makes for a profession, shifting from “an occupation that is characterised by high moral standards, including a strong commitment to the well-being of others, mastery of a body of knowledge and skills, and a high level of autonomy” to one that is increasingly influenced by commercialism, consumerism, bureaucratisation, and instances of unchecked unprofessional behaviour<sup>47</sup>.

Levels of duty that society can reasonably expect will depend on local cultural values – how rigidly is hierarchical structure adhered to, how are doctors and nurses regarded, and how immovably adamant are individuals regarding their right to self-determination and individual choice.

One example of differing expectations of the professions relates to the differences (albeit sometimes grossly generalised) between Eastern and Western values. One author writing in the aftermath of SARS concluded

it would be unlikely that Americans would have complied with the same public health measures employed in Asian or more socialist leaning countries.

Many of the Asian countries are well known for their communitarian culture, and Canada is also known for its commitment to social solidarity as evidenced by its health care system. By contrast, the United States is a heterogeneous society with a strong tradition of individualism and scepticism about government<sup>19</sup>.

Those words seem almost prophetic. Almost 20 years after they were written, the United States and the United Kingdom saw unmasked protesting crowds jostling in close proximity decrying loss of individual freedoms. While those countries saw their COVID-19 numbers skyrocket, countries like South Korea and Vietnam that enacted society-based containment have successfully controlled COVID-19.

Every society must decide ahead of crises where their moral minimum lies. Visualising this question graphically, this setpoint will establish the equipoise value for each society's model. In different societies, the location of the moral minimum on the Y axis will lie at different points between the two extremes of a “calling” and “transactional” approach to duty.

Societies must then determine how best to support and scaffold the safest and most consistent approach for their healthcare workforces to operate around that pre-determined set-point. Ahead of disaster, they must decide which actions to praise and incentivise, which to apply deterrent measures, and what reasonable mutual obligation frameworks can be established. Crucially, each society may answer these questions differently. But in proactively planning, organisations can be explicit and HCWs informed, allowing both to enter the crisis with a unified and clearly understood path.

## AN INJECTION OF POSITIVITY

The arguments presented are all couched around pandemic duty being gruelling, emotionally taxing and dangerous. An important qualification is that service may not necessarily be universally negative.

Many HCWs have entered the caring professions motivated by altruism. Rewarding moments of human connection are described here:

In a moment of compassion we are afforded a rare human experience, and for a short while, our absorbcency with the self is extinguished. We are able to cease the grinding striving for the primacy of our own existence and our own welfare and are momentarily relieved from the burden of individuality. This relief is not unlike the selflessness that comes when absorbed in great works of art. Examples of extinguishing the self can also be found in certain great lives, like that of the Buddha, where a preoccupation with self is superseded by a concern for others, and we move toward an annihilation of individuality<sup>44</sup>.

Increasing empathy, pride in a job well done in the face of great adversity, as well as the inevitable camaraderie that arises when one is inextricably linked within and dependent upon a team are some other benefits.

Being in this medical apocalypse bound us together, as a team, as brothers and sisters. We reached out to each other, checked up on each other, and took care of each other... [W]e have learned greater lessons on empathy and teamwork than we ever could have without this experience. We are better physicians than we ever could have been and can be proud of what we have done<sup>31</sup>.

The philosophers smile as they alight on this important caveat, realising that the somewhat grim analysis of their model is lightened by these more positive overlays.

## CONCLUSION

The philosophers have arrived a mutually satisfactory position on the question of HCW duty to serve during a pandemic. Neither an absolute duty to serve, nor a complete abrogation of a HCW's right to make choice is morally justifiable.

Instead, the responsibility for ensuring a sustainable workforce during a health crisis lies collectively with the professions, healthcare organisations, and society. Without this responsibility HCWs lives are put at risk and in many cases HCWs have died (Figure 2). HCWs must nurture a culture of professionalism, vocation, selflessness and collegiality, and be aware of where their individual moral minimum lies. This approach must be balanced against their need to self-care and consider competing duties such as to family.

Healthcare organisations must have a detailed understanding of their individual staff members' experience, abilities, health risk and pre-existing enjoyment of the benefits of working within healthcare. They must be agile in mobilising reciprocal supports, innovating and communicating with HCWs to ensure best protection of the vulnerable while maximising utilisation of the expertise and motivation of highly trained staff.

Societies must reflect on their individual values within ethical frameworks, and if they afford absolute autonomous rights to their populations, must be internally consistent and assume similar rights for HCWs. They must then provide the scaffolding of practical resources and cultural supports, allowing those stationed at the final garrison to safely deliver consistent and high-level care to those seeking sanctuary.

The philosophers have reached a position eloquently expressed by Reid writing in the aftermath of SARS:

Duty to care... arises from social reflection on what response to an epidemic would be consistent with our values and our needs, recognizing our shared vulnerability to disease and death. Such reflection underwrites a strong duty of care, but one not to be borne solely by the altruism and heroism of individual healthcare workers<sup>42</sup>.

Not for ourselves alone are we born, but rather, we exist as individual threads within the complex fabric of society; as we weave together creating its strength, so it scaffolds and enfolds us supporting our endeavours.

**Figure 2. This image is composed of 191 healthcare workers who died of COVID-19 in Mexico**

Permission obtained to publish from Arturo Black Fonseca.



## REFERENCES

- Nutton, V. Logic, Learning, and Experimental Medicine. *Science* 295, 800 (2002).
- Schuklenk, U. What Healthcare Professionals Owe Us: Why Their Duty to Treat During a Pandemic is Contingent on Personal Protective Equipment (PPE). *J Med Ethics* 46, 432–435 (2020).
- Amundsen, D. W. Medical Deontology and Pestilential Disease in the Late Middle Ages. *J Hist Med Allied Sci* 32, 403–421 (1977).
- Huber, S. & Wynia, M. When Pestilence Prevails ... Physician Responsibilities in Epidemics. *American Journal of Bioethics* 4, 5 (2004).
- Baker, R., Caplan, A., Emanuel, L. & Latham, S. *The American Medical Ethics Revolution*. (Johns Hopkins University Press, 1999).
- Arras, J. The fragile web of responsibility: AIDS and the duty to treat. *The Hastings Center Report* 18, S10 (1988).
- Seale, H., Leask, J., Po, K. & MacIntyre, C. R. 'Will They Just Pack Up and Leave?' – Attitudes and Intended Behaviour of Hospital Health Care Workers During an Influenza Pandemic. *BMC Health Serv Res* 9, 30 (2009).
- Hsin, D. & Macer, D. Heroes of SARS: Professional Roles and Ethics of Health Care Workers. *Journal of Infection* 49, 210–215 (2004).
- American Medical Association. Physicians' Responsibilities in Disaster Response & Preparedness. <https://www.ama-assn.org/delivering-care/ethics/physicians-responsibilities-disaster-response-preparedness> (2020).
- Ruderman, C. et al. On Pandemics and the Duty to Care: Whose Duty? Who Cares? *BMC Med Ethics* 7, 5 (2006).
- Rossow, C., Ivanitskaya, L. V., Fulton, L. & Fales, W. Healthcare Providers: Will They Come to Work During an Influenza Pandemic? in 133–147 (2013). doi:10.2495/DMAN130131.
- Alexander, G. C. & Wynia, M. K. Ready and Willing? Physicians' Sense of Preparedness for Bioterrorism. *Health Affairs* 22, 189–197 (2003).
- Van der Weijden, C. P., Bredenoord, A. L. & Van Delden, J. J. M. The Duty to Treat in the Context of an Influenza Pandemic. *Vaccine* 28, 5260–5264 (2010).
- Altman, L. K. Asian Medics Stay Home, Imperiling Respiratory Patients. *The New York Times* (2003).
- Singer, P. A. et al. Ethics and SARS: Lessons from Toronto. *BMJ* 327, 1342–1344 (2003).
- McConnell, D. Balancing the Duty to Treat with the Duty to Family in the Context of the COVID-19 Pandemic. *J Med Ethics* 46, 360 (2020).
- Mouk, Y. Coronavirus: Extraordinary Decisions for Italian Doctors. *The Atlantic* <https://www.theatlantic.com/ideas/archive/2020/03/who-gets-hospital-bed/607807/> (2020).
- Rothstein, M. et al. Quarantine and Isolation: Lessons Learned from SARS. A Report to the Centers for Disease Control and Prevention. [https://biotech.law.lsu.edu/blaw/cdc/SARS\\_REPORT.pdf](https://biotech.law.lsu.edu/blaw/cdc/SARS_REPORT.pdf) (2003).
- Vergano, M. et al. Clinical Ethics Recommendations for the Allocation of Intensive Care Treatments in Exceptional, Resource-Limited Circumstances. 8 <http://www.siaarti.it/SiteAssets/News/COVID-19%20-%20documenti%20SIAARTI/SIAARTI%20-%20Covid-19%20-%20Clinical%20Ethics%20Reccomendazioni.pdf> (2020).
- Bensimon, C. M., Tracy, C. S., Bernstein, M., Shaul, R. Z. & Upshur, R. E. G. A Qualitative Study of the Duty to Care in Communicable Disease Outbreaks. *Social Science & Medicine* 65, 2566–2575 (2007).
- Godley, J. Not in My Job Description. *American Journal of Bioethics* 8, 25 (2008).
- Tegtmeier, J. W. Ethics and AIDS: A Summary of the Law and a Critical Analysis of the Individual Physician's Ethical Duty to Treat. *Am J Law Med* 16, 249–265 (1990).
- Simonds, A. K. & Sokol, D. K. Lives on the Line? Ethics and Practicalities of Duty of Care in Pandemics and Disasters. *European Respiratory Journal* 34, 303–309 (2009).
- Clark, C. C. In Harm's Way: AMA Physicians and the Duty to Treat. *The Journal of Medicine and Philosophy* 30, 65–87 (2005).
- Rawls, J. *A Theory of Justice*. (Harvard University Press, 1971).
- Mikhail, J. Rawls' Concept of Reflective Equilibrium and its Original Function in a Theory of Justice. *Washington University Jurisprudence Review* 3, (2010).
- Kerridge, I., Lowe, M. & McPhee, J. *Ethics and Law for the Health Professions*. (The Federation Press, 2005).
- Enralgo, P., Bloom, S. & Putilo, R. Professional-Patient Relationship. in *Encyclopaedia of Bioethics* (Simon and Schuster, 1995).
- Thomson, J. A Defence of Abortion. *Philosophy and Public Affairs* 1, 47 (1971).
- Simon, J., Powers, C. & Gunnerman, J. The Responsibilities of Corporations and Their Owners. in *Ethical Theory and Business* (Prentice Hall, 1997).
- Badhey, A. K. & Laitman, B. M. If Not Us, Who? And If Not Now, When?: Perspective From a COVID-19 Intensive Care Unit Run by Otolaryngology Residents. *JAMA Otolaryngology-Head & Neck Surgery* Online ahead of print, (2020).
- Ipsos MRBI. Veracity Index 2020 - Who Do We Trust the Most? [https://www.ipsos.com/sites/default/files/ct/news/documents/2020-06/veracity\\_index\\_2020.pdf](https://www.ipsos.com/sites/default/files/ct/news/documents/2020-06/veracity_index_2020.pdf) (2020).
- Gershon, R. et al. Factors Associated with the Ability and Willingness of Essential Workers to Report to Duty During a Pandemic. *Journal of Occupational and Environmental Medicine* 52, 995 (2010).
- Coleman, C. H. Beyond the Call of Duty: Compelling Health Care Professionals to Work During an Influenza Pandemic. *Iowa Law Review* 94, 1–47 (2008).
- Malm, H. et al. Ethics, Pandemics, and the Duty to Treat. *American Journal of Bioethics* 8, 4–19 (2008).
- Kirby, M. *Holocaust - Whirligig of Emotion*. (2006).

37. Freckelton, I. Bioethics, Biopolitics and Medical Regulation: Learning from the Nazi Doctor Experience. *J Law Med* 16, 555–567 (2009).
38. Daniels, N. Duty to Treat or Right to Refuse? *The Hastings Center Report* 21, 36 (1991).
39. Saunders-Hastings, P. & Krewski, D. Reviewing the History of Pandemic Influenza: Understanding Patterns of Emergence and Transmission. *Pathogens* 5, 66 (2016).
40. Fox, D. The Politics of Physicians' Responsibility in Epidemics: A Note on History. *The Hastings Center Report* 18, S5 (1988).
41. Baron, M. Kantian Ethics and Supererogation. *The Journal of Philosophy* 84, 237 (1987).
42. Reid, L. Diminishing Returns? Risk and the Duty to Care in the SARS Pandemic. *Bioethics* 19, 348–361 (2005).
43. Urmson, J. Saints and Heroes. in *Essays in Moral Philosophy 198–216* (University of Washington Press, 1958).
44. Thomasma, D. C. & Kushner, T. A Dialogue on Compassion and Supererogation in Medicine. *Camb Q Healthc Ethics* 4, 415–425 (1995).
45. NHMRC. National Statement on Ethical Conduct in Human Research. <https://www.nhmrc.gov.au/about-us/publications/national-statement-ethical-conduct-human-research-2007-updated-2018#block-views-block-file-attachments-content-block-1> (2018).
46. Bensimon, C. M., Smith, M. J., Pisartchik, D., Sahni, S. & Upshur, R. E. G. The Duty to Care in an Influenza Pandemic: A Qualitative Study of Canadian Public Perspectives. *Soc Sci Med* 75, 2425–2430 (2012).
47. Williams, J. R. The Future of Medical Professionalism. *South African Journal of Bioethics and Law* 2, 48 (2009).

## Medicolegal insights into anaesthesia

### Chris Bolton MBBS FANZCA PhD

#### Melbourne, Australia

Dr Chris Bolton divides his professional life between private clinical practice and working as a medicolegal advisor for one of Australia's largest medical defence organisations (MDOs). He has two children, one wife and lives in domestic bliss. His current passion is downhill mountain bike-riding but he has previously represented Australia in both fencing and sailing. He was fifth in the Australian age-group triathlon championships in 2019 and, prior to COVID, was active in local amateur theatre productions.

*Disclaimer: The following article offers general advice only. Practitioners should always contact their MDO to discuss their specific situation.*

### INTRODUCTION

Fear comes in all shapes and sizes, sometimes rational, other times not. In clinical practice, true fear strikes when the patient suddenly and unexpectedly deteriorates for no obvious reason. The feeling that unknown forces are at work, and that the situation is out of the control, is truly frightening. The medicolegal world, for the majority of practitioners, is a similarly frightening place for the very same reasons. It is also a world that we are increasingly likely to be drawn into. The following chapter will attempt to shed some light on the workings of this dark place, offer some insight on how to avoid entering it, and dispel some of the less rational fears associated with it.

### AN INCONVENIENT TRUTH

Australia and New Zealand are ranked among the most highly individualistic societies in the world<sup>1</sup>. We tend to consider ourselves in the context of “I” rather than “we”. Self out-ranks community, and the mantles of previous revered community figures such as lawyers, doctors and bankers have been systematically eroded. Meanwhile, our communities' expectations of the standard of medical care are justifiably high, however, these expectations are becoming increasingly unrealistic with the widespread peddling of pseudo-medical literature and opinion on the internet. The net result is that patients are now, more likely than ever, to be dissatisfied and exercise their right to complain.

In short, our practice climate is warming up, and we have little or no control over the factors driving this change. Our best chance of survival (that is, avoiding complaints) therefore lies in understanding and adapting to our changing medicolegal environment. At the heart of this lies the concept of patient satisfaction.

### SATISFACTION

We all aim to provide exceptional care. We all aim to have satisfied patients. Sadly, this is not always the case. Patients evaluate the quality of their care by comparing their experience of care with their pre-held expectations. When there is a shortfall between the experience and the expectations, patients become dissatisfied. Dissatisfied patients complain. While this is not a particularly earth-shattering observation, it is the basis of all medicolegal notifications.

It is therefore useful to look at the factors that drive the “satisfaction equation”:

**Satisfaction = difference between what is experienced and what is expected**

Table 1 lists the factors that determine patients' experience of care while Table 2 lists those that determine patients' expectations of care.

**Table 1. Factors effecting experience of care (Draper and Hill)<sup>2</sup>**

- Communication.
- Information provided.
- Being treated with respect.
- Perceived involvement in decision making.
- The quality of the facilities.
- Level of clinical skill demonstrated.
- Waiting times.
- Continuity of care.
- Discharge planning.

**Table 2. Factors effecting expectations of care (Carr-Hill)<sup>3</sup>**

- Life-style.
- Culture.
- Previous experiences.
- Personal values.

### Dissatisfaction on the rise

Regulatory authorities in both Australia and New Zealand report that the notification rates about medical practitioners are on the rise<sup>4-5</sup>. A major Australian MDO with several thousand anaesthetist members, reports the same pattern for anaesthetists<sup>6</sup>, with one in 18 of their anaesthesia members contacting them for medicolegal advice in the year 2017-2018<sup>7</sup>. It is well recognised by MDOs that most medicolegal complaints have their roots in poor communication<sup>8</sup>.

## COMMUNICATION

Communication is both verbal and non-verbal and requires a rarely found ability to listen. It is the most potent tool we have at our disposal to bring patient experience and expectations into phase. Effective communication in the pre-anaesthetic period allows for the management of expectations, whilst communication is also integral to the experience of care (Table 1). An assessment of the quality of communication is also the basis on which patients decide whether they like practitioners or not, and experience shows that patients do not sue doctors they like<sup>9</sup>.

While practitioners are not always to blame for failed communication, they must always take responsibility for it. A recognition of this responsibility has seen an increasing number of practitioners attend communication skills workshops. These are widely available and highly recommended by MDOs.

## WHEN THINGS GO WRONG

Things do go wrong. Errors are made. Anaesthesia training focuses on how to avoid adverse events and, in the rare event that one does occur, its clinical management. Unfortunately, how to manage the patient as a person in these situations often gets overlooked.

### Open disclosure

Following the acute clinical management of an adverse event, the single most important process in the management of the patient is open disclosure. Practitioners often fear that an acknowledgement of an error will lead to litigation. In reality, quite the opposite is true. The process of open disclosure is not only part of our duty of care, it often becomes the focal point of the patient's experience of care.

Open disclosure should be done in person and be a truthful, objective account of what occurred. It is about communication and education, and making the patient feel that they are respected and cared for. The patient's

emotions should be acknowledged and supported. Open disclosure should be viewed as a process not an event, and it is often appropriate to plan a series of meetings. Many potential complaints have been avoided through effective open disclosure.

### Complaints

Not all of the people can be pleased, all of the time. When a patient is dissatisfied, it is their right to complain. If communication has failed to resolve an issue, a patient should be offered the opportunity to submit a formal complaint. This, in itself, is often a therapeutic process for the patient.

Complaints are usually directed to a third party such as an anaesthesia department or hospital, or to a regulatory body, for example, the Australian Health Practitioner Regulation Agency (AHPRA) or New Zealand's Health and Disability Commissioner (HDC). Complainants invariably seek an apology and are usually motivated by a desire to ensure that the situation does not occur again through practitioner awareness or education. Less commonly there is a desire to seek compensation or see the practitioner disciplined.

Practitioners should always take complaints seriously and respond appropriately. It is hazardous to allow the response to be delegated to others (for example, a hospital complaints officer) as it can never be assumed that a third party will respond in either a timely or appropriate fashion. All complaints should be dealt with personally, promptly, and under the guidance of an MDO.

### Why are anaesthetists contacting their MDO?

As already mentioned, anaesthetists are increasingly finding the need to contact their MDO. Table 3 summarises data published by an Australian MDO regarding the reasons for their members' notifications.

**Table 3. Reasons for MDO notifications (Australia)<sup>10</sup>**

Complaint to regulator	49%
Claim for compensation	25%
Employment dispute	12%
Coronial matter	8%
Billing audit	1%
Other	5%

These will all be discussed in turn.

### Complaints to a regulator

Anyone can make a notification to a regulatory authority. As the community watchdog, regulators are duty-bound to consider any complaint about a health practitioner. Notifications may be referred from one regulator to another depending on the nature of the complaint. Regulators have different powers but tend to have similar handling processes which will be discussed below.

Once a complaint has been received by a regulator, the practitioner is immediately notified. Rather ironically, the practitioner may not be given any details about the complaint at this stage as the investigator may consider that more information is required from the complainant to clearly identify the issues. Once the investigator has established the details of the complaint, the practitioner is asked for a response. They are provided with a complete, or partially redacted copy of the complaint and may be asked to respond to the complaint as it stands, or to a series of questions posed by the investigator. The practitioner should always involve their MDO in the drafting of the response.

Once the response is submitted, the matter is referred for assessment. Further information may be sought from the practitioner during the assessment phase to clarify certain issues. The complainant will automatically receive a copy of the practitioner's response unless a request is made to withhold it on reasonable grounds. As such, the practitioner's response becomes a further opportunity for open disclosure and education, while also demonstrating an understanding of, and sympathy to, the patient's views and experience.

Once a decision has been made on a matter, both the complainant and the practitioner are provided with the decision including the rationale for its formulation. Not all regulators have the power to impose conditions, however those that don't, have the ability to refer the matter to a regulator who does. The possible outcomes of a complaint therefore include:

- Complaint dismissal.
- Conditions or undertakings imposed on the practitioner.



- A restriction of a practitioner's practice or prescribing abilities.
- The removal of the practitioner's right to practice.

#### Mandatory reporting

Mandatory reporting to a regulator is required when a practitioner believes that they themselves, or a colleague pose a substantial risk of patient harm due to an inability to practice at the level required. In Australia, mandatory reporting applies when a practitioner's poor performance is due to:

- A mental or physical condition.
- Drug or alcohol intoxication.
- A departure from professional standards.
- When they are engaging in, have engaged in, or might engage in sexual misconduct in their clinical practice.

In New Zealand, the Good Medical Practice guidelines state that mandatory reporting applies when it is considered that a practitioner is unable to perform their duties due to:

- A mental or physical condition, or
- When they have been dismissed or resigned for reasons of competence.

The document goes on to state however, that reporting should be considered in any situation where it is reasonably suspected that a practitioner, for any reason, poses an unacceptable *risk of harm* to patients.

On a practical level, the decision to report can be a difficult one. It is based on having formed a *reasonable belief* that the practitioner poses an unacceptable risk of harm. To help establish whether this threshold has been reached in the notifier's mind, it is often useful for the practitioner to discuss the situation informally with the regulatory body, or with their MDO. It should be remembered that the decision being made is whether to report, not whether to discipline. It is up to others to investigate and make that judgement. Notifications may be made anonymously.

#### What are the rules?

The code of conduct that practitioners are expected to comply with is no mystery. Its details can be found in the Australian Medical Board's, and the Medical Council of New Zealand's, respective publications entitled *Good medical practice*<sup>11-12</sup>. These documents detail how practitioners are expected to conduct themselves in their interactions with patients, peers and staff, both within and outside of their workspace. An appreciation of the breadth of the code of conduct can be gleaned by examining the list of chapter headings given in Table 4. An even greater appreciation of the code can be gained by actually reading it.

**Table 4. Chapter headings from Good Medical Practice. A code of conduct for doctors in Australia<sup>11-12</sup>**

- Professionalism.
- Providing good care.
- Working with patients.
- Respectful culture.
- Working with healthcare professionals.
- Working within the healthcare system.
- Patient safety and minimising risk.
- Maintaining professional performance.
- Professional behavior.
- Ensuring doctor's health.
- Teaching, supervising and assessing.
- Undertaking research.

In the event of a complaint to a regulator, the standards outlined in the code are those against which a practitioner's conduct will be judged. It is obviously in the practitioner's own interests to familiarise themselves with the content of these documents.

#### Claims for compensation

Australia and New Zealand have different medical malpractice laws. The author has no experience with New Zealand's quite unique system and therefore necessarily limits his comments to Australia.

A claim for compensation due to negligence is an uncommon event and as such a less common cause of MDO notifications (see Table 3). If such a claim is made, practitioners should immediately seek the advice of their MDO.

A successful claim of negligence must demonstrate;

1. that a duty of care was owed to the patient,
2. that this duty of care was breached and,
3. that sufficient damage ensued as a result of the breach to warrant restitution.

#### Negligence – a breach of the duty of care owed

The duty of care may be breached by:

1. Failing to adequately inform, and/or
2. Failing to practice at the level expected.

If established, the patient may then may reasonably argue negligence.

#### A failure to adequately inform

The underlying tenet of our patient-centred care system is that patients are involved in their medical decision making. This requires being provided with sufficient information about the proposed management, the treatment options, and the benefits and risks of each, to allow them to make an informed decision on whether they wish to proceed or not. Practitioners must provide information in language that the patient can easily understand. This may include written information, diagrammatic information or interpreter, if necessary. Written information on its own is not considered sufficient. Patients must be given the time and opportunity to ask questions. Once this process has occurred, the discussion, and its content, must be documented in the patient notes. If there is no documentation, there is no evidence that any discussion took place.

The piece of string in all of this is, of course, which risks should be discussed. Simplistically, risks can be considered *objective* or *subjective*. Objective risks include those risks that a reasonable person, in the patient's position, would attach significance to and want to know about (a so-called *material risk*). A subjective risk is a risk that the anaesthetist is aware of, or should reasonably be aware of, that this particular patient would attach significance to (a material risk specific to this particular patient). Risks that should be considered are those that are uncommon but with serious consequences, and those that are more common with less severe consequences. The Australian and New Zealand College of Anaesthetists (ANZCA) has addressed this topic in its PS26 publication entitled *Statement on informed consent for anaesthesia or sedation*<sup>13</sup>.

It is therefore useful to consider the common causes of medicolegal claims in anaesthesia. These include dental damage (up to half of the claims), complications of neuraxial or peripheral nerve blocks, awareness, and death. A list of complications that might therefore be considered for discussion in any given pre-operative consultation is as follows (see Table 5).

**Table 5. Potential complications of anaesthesia that may be discussed in the consent process**

- Dental damage.
- Sore throat.
- Nausea and/or vomiting.
- Emergence delirium in children.
- Complications of invasive procedures including nerve blocks and arterial or central venous lines.
- Drug reactions.
- Awareness.
- Death.

### Financial consent

Practitioners in both Australia and New Zealand are expected to obtain written financial consent in any situation where the patient will incur an out-of-pocket expense for the provision of healthcare.

### A failure to practice at the level expected

To be successful, a claim of negligence in this area must clearly demonstrate that the practitioner's performance has fallen below the level expected of their peers. When clinical issues are under scrutiny, the court will be guided by the opinions of respected peers acting as impartial expert witnesses. Expert witnesses necessarily make their assessment of practitioner's performance based largely on the practitioner's documentation. As always, good contemporaneous documentation is the key to a successful defense.

### Restitution

If it is concluded the patient experienced sufficient damage as a result of a breach of the duty of care, the issue of compensation arises. Assuming that practitioners have practiced within the terms of their indemnity policy, financial compensation and legal costs will be the responsibility of the MDO.

### Employment issues

Most MDOs offer industrial relations advice to their members. Industrial relations advice may also be sought from medical unions or from privately engaged solicitors.

### Coronial matters

Anaesthetic-related deaths are rare. Unfortunately, they do occur, and the anaesthetist will often be required to make a submission to the coroner. The coroner's job is to make a determination on the likely cause of death, significant contributing factors, and to make relevant recommendations based on their investigation. It should be noted that the coroner's findings in Australia and New Zealand are open to public discovery and may be used in, or trigger, subsequent litigation. Any submission to the coroner should be therefore be accurate, detailed and reviewed by an MDO prior to its submission.

An insight into the common causes of anaesthetic-related deaths may be obtained from publications such as the Victorian Consultative Council on Anaesthetic Morbidity and Mortality's (VCCAMM) triennial reviews of perioperative deaths. In the 2015-2017 triennium, for example, 181 perioperative deaths were examined, of which 58 were determined to be anaesthetic related<sup>14</sup>. The causes of these anaesthetic related deaths are given in Table 6.

**Table 6. Causes of 58 anaesthetic-related deaths. VCCAMM 2015-2017**

Cardiovascular (cardiac arrest, significant hypotension, myocardial ischaemia and infarction).	32 (55%)
Respiratory (aspiration, pneumothorax).	9 (16%)
Neurological (stroke).	7 (12%)
Drug related (anaphylaxis, adverse drug response).	6 (10%)
Airway (failed intubation).	2 (3%)
Other.	2 (3%)

### Audit

In Australia, Medicare is increasingly focusing its attention on medical practitioners' billing practices. Individuals whose billing practice is statistically different from that of their peers (that is, above the 95th percentile) are likely to come under scrutiny. These practitioners will be then contacted and may be offered:

1. A chance to review and reflect on their current billing practice and have their billing reviewed for another six months. If it is then established that there has been a change, the matter may then be considered closed,
2. an opportunity to meet with investigators to explain why they are an outlier, and/or
3. be the subject of an external audit. In this situation, the hospital notes are reviewed by a peer seeking evidence to support the use of the claimed item numbers.

It is the responsibility of the individual practitioner to educate themselves about the appropriate use of anaesthesia item numbers. It is understood that practitioners make mistakes however, if payments have been made that were not due, Medicare will expect to be reimbursed. If there is evidence that erroneous billing is

intentional, the practitioner may be charged with fraud. As with all medicolegal matters, good documentation is the practitioner's best defense.

### Social media

Social media is perhaps the most disturbing recent development for the medicolegal world. Not only does it represent a new forum in which practitioners can behave badly, but it also presents an unregulated platform for the anonymous criticism of practitioners. While it is incredibly distressing to be unfairly targeted, the moderators of these forums defend their users' right to free speech. Once a negative review has been posted the chances of affecting its removal are low. Responding to these criticisms online is fraught with hazard. As always, practitioners should discuss their individual situation with their MDO.

## DOCUMENTATION: IF YOU DIDN'T DOCUMENT IT, IT DIDN'T HAPPEN

If there is one thing that helps protect a practitioner in the event of an investigation of any sort, it is the ability to produce good quality, contemporaneous clinical notes. The rule of thumb for the standard of documentation required in anaesthesia is that a colleague could safely take over the care of the patient based solely on a review of the notes or, on review of the notes, confidently conclude that the duty of care owed to the patient had been fulfilled (see section: Negligence). Unfortunately, anaesthetists' documentation often leaves a lot to be desired. As such, there is little that they can do to defend themselves. Very simplistically, from a medicolegally point of view, if it wasn't documented, it didn't happen.

## WELLBEING

An accusation of incompetence or negligence is incredibly confronting. Despite the fact that we are all human, and that we all make mistakes, practitioners are often blind-sided by the intensity of the emotions they experience. Feelings of persecution, anger, and guilt are common. There is also fear; a fear of being judged by (often ill-informed) colleagues, a fear of repercussions, and most of all, a fear of the unknown. Occasionally it is the practitioner's health that is at the heart of the problem but more often, it is the incident or complaint itself that pierces the wellbeing bubble.

While the MDO will help the practitioner navigate the technical aspects of a notification, it is incumbent upon practitioners to look after themselves and seek help if required. Debriefing with a respected peer and seeking the support of colleagues, friends and family is important. Time and support are far more therapeutic than drugs and alcohol. As medical practitioners, we are trained to help others. It is reasonable to assume therefore, that we would also be capable of extending ourselves to ask a troubled colleague if they are OK.

Professional help is readily accessible. A confidential "doctors-for-doctors" hotline is available in every state and territory in Australia and in New Zealand. Contact details of the individual services can be found on the Doctors' Health and Advisory Service website<sup>15</sup>.

## CONCLUSION

My concluding comment on all things medicolegal is "if you don't know, ask". You pay your MDOs large sums of money so please use them. It's better to avoid trouble than to have to dig yourself out of a huge, steaming pile of it.

## REFERENCES

1. Hofstede insights. [Internet]. [cited 2021 Feb 9]. <https://www.hofstede-insights.com/country-comparison/australia/>
2. Draper, M and S Hill (1995). The role of patient satisfaction surveys in a national approach to hospital quality management, Australian Government Publishing Service: 20, 53.
3. Carr-Hill, R.A. (1992). "The measurement of patient satisfaction." *Journal of Public Health Medicine* 14(3): 236-49.
4. AHPRA in numbers. AHPRA and National Boards. (2020) [Internet]. [cited 2021 Feb 4]. <https://www.ahpra.gov.au/About-Ahpra/What-We-Do/Ahpra-in-numbers.aspx>
5. HDC annual report. Health and Disability Commissioner. (2019) [Internet]. [cited 2021 Feb 4]. <https://www.hdc.org.nz/media/5392/hdc-2019-annual-report.pdf>
6. Complaints for regulators drive anaesthetist's medicolegal matters. Avant Media (2017). [Internet]. [cited 2021 Feb 8]. <https://www.avant.org.au/news/anaesthetists-medico-legal-matters/>.
7. Compensation claims and complaints insights. Anaesthetists. Avant Media (2017) [Internet]. [cited 2021 Feb 8]. <https://www.avant.org.au/news/calls-from-anaesthetists-for-advice/>
8. Complaints culture. Medical Protection Society (2020). [Internet]. [cited 2021 April 10]. <https://www.medicalprotection.org/uk/articles/complaints-culture>
9. Huntington, B and Kuhn, N (2003). Communication gaffes: a root cause of malpractice claims. *Proc (Bayl Univ Med Cent)*. 2003 Apr; 16(2): 157-161.

10. Complaints for regulators drive anaesthetist's medicolegal matters. Avant Media (2017). [Internet]. [cited 2021 Feb 12]. <https://www.avant.org.au/news/anaesthetists-medico-legal-matters/>
11. Good Medical Practice: a code of conduct for doctors in Australia. Medical Board AHPRA (2020) [Internet]. [cited 2021 Feb 16]. <https://www.medicalboard.gov.au/codes-guidelines-policies/code-of-conduct.aspx>
12. Good Medical Practice. Medical Council of New Zealand (2016). [Internet]. [cited 2021 Feb 18]. <https://www.mcnz.org.nz/assets/standards/85fa1bd706/Good-Medical-Practice.pdf>
13. Statement on informed consent for anaesthesia or sedation. ANZCA PS26. (2020). [Internet]. [cited 2021 Feb 25]. [https://www.anzca.edu.au/getattachment/d11e9c7e-0825-458a-af47-7a21ddb588a7/PS26-Statement-on-informed-consent-for-anaesthesia-or-sedation-\(PILOT\)](https://www.anzca.edu.au/getattachment/d11e9c7e-0825-458a-af47-7a21ddb588a7/PS26-Statement-on-informed-consent-for-anaesthesia-or-sedation-(PILOT))
14. Victorian Consultative Council on Anaesthetic Morbidity and Mortality. Triennial Report 2015-2017. [Internet]. [cited 2021 March 1]. [https://www.bettersafecare.vic.gov.au/sites/default/files/2019-09/02025\\_VCCAMM\\_triennial\\_2015\\_2017\\_WEB.pdf](https://www.bettersafecare.vic.gov.au/sites/default/files/2019-09/02025_VCCAMM_triennial_2015_2017_WEB.pdf)
15. Contact DHAS in other States, Territories and New Zealand. Doctor's Health Advisory Service. [Internet]. [cited 2021 March 5]. <http://www.dhas.org.au/contact/contact-dhas-in-other-states-territories-and-new-zealand.html>

## Media moments for anaesthetists

### Simon Hendel MBBS (Hons) FANZCA GDip Journalism

#### The Alfred, Melbourne

Dr Simon Hendel is an anaesthesiologist at The Alfred in Melbourne and has completed post graduate qualifications in journalism. He has worked in a number of freelance media roles including as the medical advisor and fact checker for the ABC television series *Ask The Doctor* and *Catalyst*. His articles have appeared in *The Conversation*, *The Age*, *The Sydney Morning Herald*, *Executive Style* and *MJA InSight Plus*. As far as he knows, he has never influenced anyone in particular on social media.

### Jonathan (Joff) Lacey BMedSci BMBS MSc FRCA

#### The Alfred, Melbourne

Dr Joff Lacey is a British-trained anaesthetist who is completing his fellowship at The Alfred in Melbourne. He has enjoyed a range of media experiences, including as presenter and scientific adviser for the award-winning medical documentary series *The Cure*, and as a member of the presenting team for the online professional development platform *TopMedTalk*.

## INTRODUCTION

There has been a media revolution. Across the past decade traditional media has been disrupted. The meteoric rise of online news and content providers, social-media platforms, and user-driven-content has blurred the lines separating publisher, journalist and consumer. This growth has been driven by an insatiable consumer appetite for information and simultaneous engagement. Media of various platforms has become both more overt and insidious across our personal and professional lives. Social media (SoMe) forums (including Facebook, Twitter and YouTube) enjoy a staggering four billion active users worldwide<sup>1</sup>; no fewer than 500 million tweets are sent each day<sup>2</sup>. With myriad sources at our fingertips it has never been easier to access entertainment, marketing and news – and never harder to discern the difference.

The disruption of traditional media and democratisation of information and production has had undeniable benefits, beyond the profits of Twitter and Google. But the other side of this double-edged sword has been a surgeon's scalpel. Like a cosmetic surgeon cutting and slicing and stitching together to create the appearance of youth, traditional media organisations have gone under the knife. Many can barely be recognised except by their closest friends. Newsrooms are decimated, journalist job numbers slashed, the subscription/advertising business model excised. Anyone with an iPhone can take and distribute visual media faster than any news agency at the turn of the 21st century – so who needs photojournalists?

It is only on reflection that we realise the velocity and extent of this disruption: it is fewer than 15 years since the first iPhone was released; and only 25 years ago that *The Age* newspaper (Melbourne-based Channel 9/Fairfax masthead) first published an article online in January 1995 – at that time fewer than 250,000 Australians had access to the internet.

While the medical world is renowned for its conservatism and relatively cautious approach, it too has witnessed the explosion of social media and disruption of traditional media as a means of communication and engagement. This has conferred tremendous advantages, allowing information dissemination to previously unreachable audiences, at a rate unparalleled in the evening news.

Medicine has always had a strong relationship with the entertainment industry too, with a long list of popular medical dramas. But we are now seeing a surge in the media presence of real-life medical professionals providing their expertise. The term “media” no longer refers to a limited number of (trusted) corporate organisations involved in mass communication; the *individual* now has the capability to be a media outlet. Cue the rise of the Citizen Journalist (and the fall of the sub-editor!).

The opportunity and advantages of the medico-media relationship are vast, but so is the potential harm. And for doctors at all levels, understanding these risks and opportunities is now an essential part of professional practice. In this article we will discuss the opportunities, as well as the liabilities, for anaesthetists associated with media engagement and ultimately why we should embrace the revolution.

## MEDICS IN THE MEDIA

The media opportunities for medical professionals are varied and numerous: newspaper columns, scriptwriting, novels, popular science books, documentaries, news commentary, podcasts, children's television programs, blogs, and medical education videos to name a few. Talking-head-health-experts are in such high demand that there are talent agencies specialising in managing the careers of medicos in the media.

Physicians are particularly attractive to production companies and journalists' contact books, not only for their expert knowledge but also because they remain broadly trusted by the public<sup>9</sup>. With the advent of social media and an increasing comfort with online public presence, medics have demonstrated prolific activity that includes provision of expert opinion, distribution of journal articles, political discussion and live debate. Unprecedented is a word that has taken on new meaning across the past 12 months in the face of the coronavirus pandemic. And while we have found ourselves in unprecedented times, so too we have witnessed an extraordinary volume of medical engagement and contribution to the media. With so much unknown and so little time to acquire knowledge, medical professionals flooded the internet. Social media has emerged as one of the primary sources of medical update and opinion and, for better or worse, shows no sign of abating. Social media use and engagement presents significant opportunities to broaden the reach and audience for communication by anaesthetists – both within the profession and to the public.

## ANAESTHETIC OPPORTUNITY

Not traditionally a profession at ease with publicity and promotion, it is important that we use the opportunities afforded by the media to the advantage of both clinicians and patients alike. Whether for public educational resources, research updates or organisational promotion, the media provides enormous potential for advancement of the specialty.

### Research and education

Research and education are core tenets of advancing the science of anaesthesia. Social media provides a unique platform that allows anaesthesiologists to connect with colleagues, patients and the public alike<sup>4-6</sup>. It enables accessible, far-reaching, real-time conversation on perennial clinical challenges as well as recent discoveries and emerging trends. Key findings in the latest articles, from the most high-impact journals can be disseminated across the world in minutes.

Platforms such as Twitter, if viewed through the lens of open access to information, serve as a conduit to information that may otherwise be protected by a journal subscription pay-wall, or simply too difficult to find. Use of social media as a means to disseminate information is unrivalled. This has its risks too, of course. While reputable information can be readily shared with people who may otherwise not have had access to it, so too can poor-quality information or even deliberate misinformation.

For scientists trying to spread the news of their research findings, using social media has become essential. But competing with the torrent of variable information being shared is perhaps the greatest challenge. Peaking above the noise level and being heard is not easy. While not looking directly at published research, a 2018 study by the data science department at the Massachusetts Institute of Technology (MIT) in the United States of America, and published in the journal *Science*, analysed 126,000 stories tweeted by three million users. The key findings of the researchers: fake news, false stories and rumours penetrate much deeper into the social network than verified accurate stories<sup>7</sup>. This risk has not been studied specifically in terms of sharing of scientific research, but it highlights the challenge associated with reaching an audience with accurate information. However, that is not cause to disengage or even for alarm – it simply highlights the need for vigilance and critical appraisal of data. The benefits of social media engagement for the dissemination of research and sharing of science, vastly outweigh the detriments.

Indeed, as we have said, Twitter in particular has democratised access that would previously have been severely restricted. Conferences provide specific hashtags to allow live tweeting, informing clinicians unable to attend in person. Free, open access educational resources allow any anaesthetist with an internet connection to access training from experts in the field. And although social media is challenging the traditional model of scientific publishing as we have discussed, it can also be complementary – there is evidence of an association between a journal's Twitter activity and an increase in its impact factor when compared to those journals with less social media presence<sup>8</sup>.

### Public engagement

The capacity for doctors to engage directly with the public has increased dramatically in recent years, conferring many advantages for both the medical expert and the community. Improved opportunities for cross-platform presence, whether via traditional broadcast media, online news, websites, or social media, has the potential to increase public understanding, foster trust, and demystify aspects of healthcare that otherwise contribute to anxieties.

Anaesthesiologists in particular have an important role to play in clearly communicating the reality of our specialty. There is reasonable evidence that alleviating anxiety prior to medical intervention or surgery improves postoperative patient satisfaction<sup>9</sup>. When popular fiction and film representation of anaesthesia either relegates us to a masked background lackey of hero surgeons, or focuses on the (very rare) complication of awareness<sup>10</sup>,

anaesthesiologists surely have their work cut out for them. Engaging publicly is perhaps the best way we can foster the type of awareness that is important for patient safety and comfort: an awareness of what it is we really do. It is perhaps an unfortunate by-product of the success and safety of our unique medical specialty that many do not understand what happens when they go under the knife nor the extensive role that anaesthetists play in modern healthcare<sup>11</sup>. However, engaging with the public through various forms of media is our opportunity to improve that understanding.

Public engagement may include a diverse range of activities including science festivals, museum exhibits, public lectures and school workshops, but also direct engagement with (social) media.

The successful Australian and New Zealand College of Anaesthetists (ANZCA) National Anaesthesia Day<sup>12</sup> is another example of important efforts for our profession to connect with the public. This variety of engagement provides opportunities to promote and inform the public about anaesthetists, our expertise and our responsibilities.

It is also logical that a better-informed public may also lead to improved outcomes, not only in terms of patient satisfaction but in the shared-decision making processes that are often left wanting in anaesthesia<sup>13</sup>.

### A healthy balance

As we have touched on, health misinformation in the media is well established and is an inevitable cost of engaging across multiple sources of media. Misinformation can occur through a variety of mechanisms. Dramatisation or misrepresentation of clinical decision making and patient outcomes in popular fictional medical shows can result in inaccurate and unmet public expectations of medical practice<sup>14</sup>. The relative lack of coverage of medical research in mainstream media<sup>15</sup>, coupled with the myriad dangers of an unedited, universally accessible online platform without peer-review, perpetuate health misinformation<sup>16,17</sup>. Healthcare professionals can play an important role in providing a counterbalance – as a profession it is our duty to inform and advise. We can use the media to ensure that any such inaccuracies are corrected. With a co-ordinated response, social media's power to misinform and agitate, may also be used to educate and calm.

## PITFALLS AND CAUTIONARY TALES

Where there is opportunity, there is also risk. The line between private online life, or even personal opinion, and professional responsibility as a doctor is now entirely blurred. Understanding this is the crucial first step in regulating online presence. Whether for better or worse, our online presence, including photos posted on Facebook, comments on news articles, Twitter arguments and shared media, are available for all in perpetuity. So, what we engage with, post, share, and comment on builds a picture of who we are in the online space. As that profile increasingly articulates with who we are in the "real" world, the greater the impact it can have on professional standing, employment prospects and reputation.

Institutional guidance from professional associations such as the Australian Medical Association<sup>18</sup> and regulatory agencies including Australian Health Practitioner Regulation Agency (AHPRA)<sup>19,20</sup> are necessary and an important barometer for doctors engaging with social media.

Likewise, most hospitals have policies relating to staff engagement with mainstream media and many will require staff to seek advice and counsel with their media affairs department to discuss potential comments or media engagement. In some cases, this may be a contractual requirement. This should not dissuade doctors engaging with the media – merely provide them with a clear framework for doing so.

Speaking with journalists is not something that should be feared or avoided. Most are not trying to catch you out or trip you up. In the circumstance of communicating research or science, most are simply trying to detechnicalise complicated material for a wider lay audience.

Communicating areas of technical or scientific expertise in plain English and avoiding jargon is the best way to ensure your message is not lost in translation. Some clinicians may wish to undertake formal training to improve their confidence and efficacy of communicating with journalists and the media. Again, contacting your hospital's media affairs department is a good first step as they may provide in-house training or advice on reputable training opportunities. Another excellent resource is the Australian Science Media Centre (AusSMC) – an independent, not-for-profit organisation that aims to improve the quality of science communication in the media for the greater good of the Australian public. AusSMC act as an impartial and trusted nexus between scientists and journalists; they provide support to the media in reporting accurately on complex scientific matters including finding reliable sources, and likewise they encourage the experts to engage proactively with the media. To that end, AusSMS provides scientists and healthcare professionals with numerous training resources and workshops aimed at honing media skills<sup>21</sup>.

Engaging with mainstream media and talking to journalists is usually a much more structured process and less common than inadvertently exposing yourself to risk on social media. It is well documented that social media use for the physician is fraught with personal, practical and ethical challenges<sup>22,23</sup>. The reality is that any comment on a personal profile can be linked back to you professionally, so if you wouldn't be happy seeing your comments front page of a national newspaper then think twice about publishing them on a social media platform (Table 1<sup>24,25</sup>).

**Table 1. Examples of disciplinary action taken against medics as a result of social media activity**

**The Medical Board of Australia v Lee (2019)<sup>24</sup>:**

Dr Lee was a registrar in emergency medicine when he received a suspension from the medical register for professional misconduct. The verdict was in relation to comments made on social media, including overseas-based platforms. Despite the private capacity in which these comments were made, Dr Lee was easily identifiable as an Australian medical professional. The remarks were highly offensive and often morally reprehensible and prompted notification of the Medical Board, eventually leading to disciplinary action. Although an extreme example, the case demonstrates the blurring of private/professional boundaries in the online world and highlights that it is our duty to maintain professional standards in all spheres of life. Published guidance from AHPRA states that "National boards may consider social media use in your private life (even where there is no identifiable link to you as a registered health practitioner) if it raises concerns about your fitness to hold registration<sup>20</sup>".

**The Medical Board of Australia v Ellis (2020)<sup>25</sup>:**

Dr Ellis was a Melbourne-based GP. The manager of the practice where he worked notified the Medical Board of Australia with concerns regarding the doctor's social media activity. Dr Ellis had posted material and comments regarding his controversial opinions on vaccines, chemotherapy and other medical interventions. Following an investigation, the board deemed that Dr Ellis posed a risk to public health and safety, either through broadcasting his views or practicing medicine in alignment to them, and therefore deemed it appropriate to suspend his registration with immediate effect. When you post on social media it is broadcast to the world and is irretrievable. Clinicians are welcome to their personal views and opinions but they must uphold the ethical and behavioural code of our profession. AHPRA states that a doctor "who makes comments, endorses or shares information which contradicts the best available scientific evidence may give legitimacy to false health-related information and breach their professional responsibilities<sup>20</sup>".

## STATISTICAL LITERACY AND COMMUNICATION

The pervasive lack of statistical literacy poses a greater threat to effective scientific communication than any disruption of mainstream media. It is also exploited as a means to sensationalise science stories – whether with intent or through ignorance. Statistics are fundamental to scientific enquiry and any misrepresentation of statistical findings takes us further away from understanding the truth.

Concepts such as statistical significance, association, causation, specificity and sensitivity are not well understood and while accurately applied statistics describe and clarify uncertain situations, they can bamboozle the unfamiliar with equal measure. Most important is the concept of *risk*; both in terms of data presentation and the communication of risk.

Many medical treatments and interventions aim to mitigate risk posed to patients by diseases. In order for doctors and patients to make appropriate decisions in the best interests of the individual they must understand and balance proposed benefits and risks.

Communicating risk is therefore fundamentally important. However, doing so is fraught. Not only is the application of population risk prone to misunderstanding and error (no matter how low the odds are, risk is binary for the individual), humans are also terrible at assessing risk to the individual in the first place.

Even highly educated people, including healthcare professionals, can have difficulty grasping numerical concepts important to understanding concepts of risk<sup>26,27</sup>. That imprecision at assessing risk has been highlighted during the past few months as a number of effective vaccines for SARS-CoV-2 have become available. Especially in jurisdictions such as Australia where COVID-19 has been largely controlled (and despite logistic challenges in making vaccines available) an emerging hesitancy to certain vaccines has dominated media reports and twitter threads. Simultaneously and on the other hand, there is a lethargy about the risks of actually contracting COVID-19. This is not helped by media reporting of every potential vaccine-associated complication, whether verified or not, at the same time as daily "double-doughnut" case numbers. As medical

specialists, who are in the main not also vaccine specialists, we have a very real responsibility to be measured, balanced and accurate in our commentary on social media – as well as in actual society!

Grappling with the communication of risk has been a challenge for far longer than the Astra-Zeneca SARS-CoV-2 thrombosis risk was first suggested. In the world of science communication, a battle exists between absolute and relative risk – and to the victor goes the headline. So, it is inevitably relative risk, without the corresponding context and grounding of absolute risk, that grabs the story. Also, when absolute numbers are very low it can be very difficult to appreciate the risk. Relative risk, although an extremely useful statistic, can be misleading to the general public. It is often more persuasive with the numbers involved being much greater than absolute terms.

A New Zealand study demonstrated that participants were far more likely to consent to a proposed intervention when its supposed benefits were framed as a relative risk reduction than when compared to the exact same benefit communicated in terms of absolute risk reduction<sup>28</sup>. We wield incredible influence when we frame risk in a particular way and we must be mindful of that influence when we communicate and commentate. Perhaps using more than one method to communicate risk may mitigate effects of framing? Misplaced commentary on risk can undo the great efforts made through research to accurately determine and communicate risk.

To be fair to us all, understanding, let alone communicating, statistical risk is no easy feat. Sir David Spiegelhalter is a British statistician who has published extensively on the methods, and difficulty, of communicating the complexities of risk to the general population. For those among us keen to wade into the Twittersphere or mainstream commentary, his work is well worth reviewing regardless of your statistical competencies<sup>29,30</sup>.

## CONCLUSION

There are many benefits to medical practitioners and, more specifically, anaesthesiologists, engaging with the media. Mainstream news, documentaries, blogs, social media and medical education resources all provide opportunities for contributing to professional and public discussions that improve the quality of healthcare. As with any opportunity, though, there are risks.

"Twitter is the graveyard of nuance, the assassin of good public policy and the enemy of consensus," according to Dr Nick Coatsworth, the former Commonwealth Deputy Chief Health Officer<sup>31</sup>. As anyone who has ventured into the world of social media commentary knows, there is a regression to base and a preference for the "pile on" in any conversation that attempts to grapple with nuance. This is not a reason to disengage, rather it is all the more important that we are advocates of reason, deliberate in our rational and fact-based debate, and considerate of the people behind the handle.

We are in an exciting information age and in order to stay both expert and relevant, it is important that we continue to build our expertise and comfort engaging with media of all varieties.

## PERSONAL DISCLOSURES

The authors' personal experience in the media has been primarily in television (science documentaries) and print journalism. Our involvement has been overwhelmingly positive both in terms of professional and personal impact. The creative world of the media provides an appealing balance to the technical precision of clinical anaesthesia practice.

As a healthcare professional it is all too easy to become blasé about the wonders of science and medicine; reporting these to the public provides welcome insight into the privilege of our working environment. It remains a component to our professional lives that provides great fulfilment and satisfaction, and one we both hope to continue throughout our careers. We would encourage any colleagues with an interest to pursue them keenly.

## REFERENCES

1. Global social media stats. <https://datareportal.com/social-media-users>.
2. Twitter usage statistics. <https://www.internetlivestats.com/twitter-statistics/>.
3. Hesse BW, Nelson DE, Kreps GL, et al. Trust and Sources of Health Information. *Arch Intern Med.* 2005;165(22):2618. doi:10.1001/archinte.165.22.2618
4. Schwenk ES, Chu LF, Gupta RK, Mariano ER. How Social Media Is Changing the Practice of Regional Anesthesiology. *Curr Anesthesiol Rep.* 2017;7(2):238-245. doi:10.1007/s40140-017-0213-x
5. Kearsley R, MacNamara C. Social media and online communities of practice in anaesthesia education. *Anaesthesia.* 2019;74(9):1202-1203. doi:10.1111/anae.14764
6. Haldar R, Kaushal A, Samanta S, Ambesh P, Srivastava S, Singh P. Contemporary social network sites: Relevance in anesthesiology teaching, training, and research. *J Anaesthesiol Clin Pharmacol.* 2016;32(3):382. doi:10.4103/0970-9185.188821

7. Vosoughi S, Roy D, Aral S. The spread of true and false news online. *Science*. 2018;359(6380):1146-1151. doi:10.1126/science.aap9559
8. Duffy CC, Bass GA, Linton KN, Honan DM. Social media and anaesthesia journals. *Br J Anaesth*. 2015;115(6):940-941. doi:10.1093/bja/aev389
9. Mathew A, Koshy P, Mariyam S, Ipe S, Ramasami P. The role of demystifying anaesthesia in allaying anxiety and improving post-operative patient satisfaction in a tertiary care centre: A randomised control trial. *Indian J Clin Anaesth*. 2020;7(2):272-278. doi:10.18231/ijca.2020.049
10. Harold J. Awake. United States: The Weinstein Company; 2007.
11. Braun AR, Leslie K, Morgan C, Bugler S. Patients' Knowledge of the Qualifications and Roles of Anaesthetists. *Anaesth Intensive Care*. 2007;35(4):570-574. doi:10.1177/0310057X0703500417
12. Australian and New Zealand College of Anaesthetists (ANZCA) National Anaesthesia Day. <https://www.anzca.edu.au/safety-advocacy/advocacy/anzca-national-anaesthesia-day>. Accessed May 3, 2021.
13. Stubenrouch FE, Mus EMK, Lut JW, Hesselink EM, Ubbink DT. The current level of shared decision-making in anesthesiology: an exploratory study. *BMC Anesthesiol*. 2017;17(1):95. doi:10.1186/s12871-017-0386-3
14. Diem SJ, Lantos JD, Tulsy JA. Cardiopulmonary Resuscitation on Television — Miracles and Misinformation. *N Engl J Med*. 1996;334(24):1578-1582. doi:10.1056/NEJM199606133342406
15. Dumas-Mallet E, Smith A, Boraud T, Gonon F. Poor replication validity of biomedical association studies reported by newspapers. *Wicherts JM, ed. PLoS One*. 2017;12(2):e0172650. doi:10.1371/journal.pone.0172650
16. Trethewey SP. Medical Misinformation on Social Media. *Circulation*. 2019;140(14):1131-1133. doi:10.1161/CIRCULATIONAHA.119.041719
17. Swire-Thompson B, Lazer D. Public Health and Online Misinformation: Challenges and Recommendations. *Annu Rev Public Health*. 2020;41(1):433-451. doi:10.1146/annurev-publhealth-040119-094127
18. Australian Medical Association. A guide to social media & medical professionalism. <https://ama.com.au/articles/guide-social-media-and-medical-professionalism>. Published 2020. Accessed May 3, 2021.
19. General Medical Council. Doctors' use of social media. <https://www.gmc-uk.org/ethical-guidance/ethical-guidance-for-doctors/doctors-use-of-social-media#>. Published 2013. Accessed May 3, 2021.
20. Australian Health Practitioner Regulation Authority (AHPRA). Social media: How to meet your obligations under the National Law. <https://www.ahpra.gov.au/Publications/Social-media-guidance.aspx>. Published 2019. Accessed May 21, 2021.
21. Australian Science Media Centre. <https://www.smc.org.au/experts>. Accessed May 30, 2021.
22. Jain SH. Practicing Medicine in the Age of Facebook. *N Engl J Med*. 2009;361(7):649-651. doi:10.1056/NEJMp0901277
23. Ventola CL. Social media and health care professionals: benefits, risks, and best practices. *P T*. 2014;39(7):491-520.
24. Lee v Medical Board of Australia [2019] TASHPT 3.
25. Ellis v Medical Board of Australia (Review and Regulation) [2020] VCAT 862.
26. Lipkus IM, Samsa G, Rimer BK. General Performance on a Numeracy Scale among Highly Educated Samples. *Med Decis Mak*. 2001;21(1):37-44. doi:10.1177/0272989X0102100105
27. Gigerenzer G, Gaissmaier W, Kurz-Milcke E, Schwartz LM, Woloshin S. Helping Doctors and Patients Make Sense of Health Statistics. *Psychol Sci Public Interes*. 2007;8(2):53-96. doi:10.1111/j.1539-6053.2008.00033.x
28. Sarfati D, Howden-Chapman P, Woodward A, Salmond C. Does the frame affect the picture? A study into how attitudes to screening for cancer are affected by the way benefits are expressed. *J Med Screen*. 1998;5(3):137-140. doi:10.1136/jms.5.3.137
29. Spiegelhalter D, Pearson M, Short I. Visualizing Uncertainty About the Future. *Science* (80- ). 2011;333(6048):1393-1400. doi:10.1126/science.1191181
30. Spiegelhalter D. Risk and Uncertainty Communication. *Annu Rev Stat Its Appl*. 2017;4(1):31-60. doi:10.1146/annurev-statistics-010814-020148
31. Coatsworth N. "Activist" doctors' phoney pandemic wars put recovery at risk. *Sydney Morning Herald*. <https://www.smh.com.au/national/activist-doctors-phoney-pandemic-wars-put-recovery-at-risk-20210514-p57ryn.html>. Published 2021. Accessed May 21, 2021.

